

Laundry

Architectural Designer Products



Adp

The ADP Difference



Laundry & photography by DIY Darma.



Buying Australian made means quality you can trust.

All of our cabinets are made from 100% Australian made board and are manufactured in our factory which is located just south of Sydney.

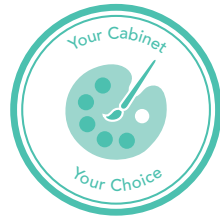

Personalise your laundry.

Choose from a wide variety of cabinet and benchtop colours, giving you endless combinations to find the style that's perfect for you.



Custom width cabinets.

All of our cabinets and benchtops are manufactured in-house, allowing us to custom make cabinets to the exact width needed.



ADP is committed to a sustainable future.

Buying locally made products means less carbon footprint. All of our cabinets are made from Australian board that is sourced from sustainably managed forests. Our environmental philosophy drives every aspect of our manufacturing process as we strive to minimise waste and maximise efficiency.



10 Year Warranty on cabinetry.

We believe our warranty is proof of our ongoing commitment to supply quality products. However, if something does go wrong, our highly trained team are here to help.





Contents

Where To Start	6
Choose Your Style	10
Modular Laundry Components	18
Custom Option Pricing	27
All-In-One Sink	28
Sinks	30
Tapware	34
Laundry Accessories	36
Handles	38
Cabinet Finishes	40
Benchtap Finishes	44
Warranty	46
Get The Look	48

Where to start?

Plan Your Layout

Measure Your Space

- Overall size of laundry.
- Floor to ceiling - we offer cabinets to suit different ceiling heights.
- Wall to wall. Don't forget to allow for tiles if the walls haven't been tiled yet.
- Size and location of doors and door clearances, windows and architraves.
- Waste and/or pipe positions.

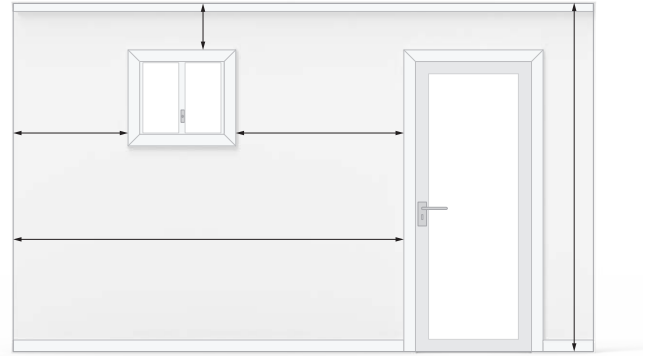

Choose Your Layout

Once you know how much space you have to work with, think about the layout of the laundry.

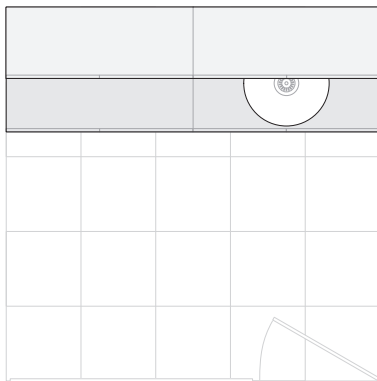

Straight run laundry

Ideal for small and narrow areas. Simple and practical.

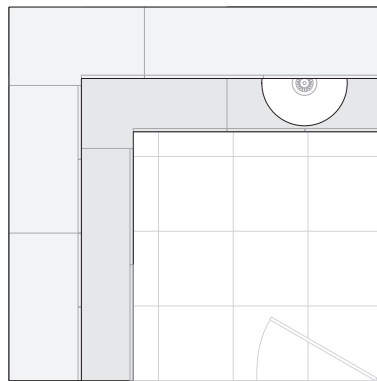

L-Shaped laundry

Suits a larger area, giving you ample bench space and storage options.

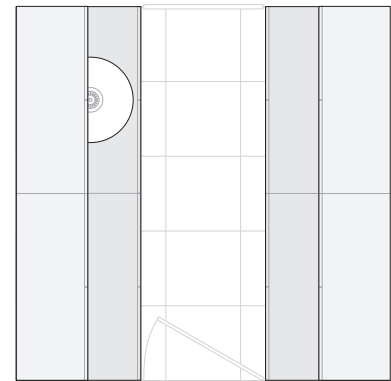

Galley laundry

Ideal for wider areas. Ensure you think about function, for example where do you want to place the hampers in relation to your appliances etc.

Custom Width Cabinets

Most of our modular cabinets can be shrunk down in width between standard sizes for wall-to-wall applications. See page 27 for pricing.

How to make the most of customisable widths

Use our standard sized modular cabinet to fill the majority of your laundry, then order a custom width cabinet to fit the remaining space perfectly.



CUSTOM OPTIONS

Plan Your Layout

It's time to start drawing up your laundry layout. To start selecting your modular cabinets go to page 18.

Things to Keep in Mind

- Locations of existing and future power points, plumbing, light fixtures etc.
- Check if the floor is level.
- The amount of room that doors and windows need to open.
- The size of your washing machine and dryer.
- Access points for installation - where will the cabinets be carried in from and will they fit through the door?

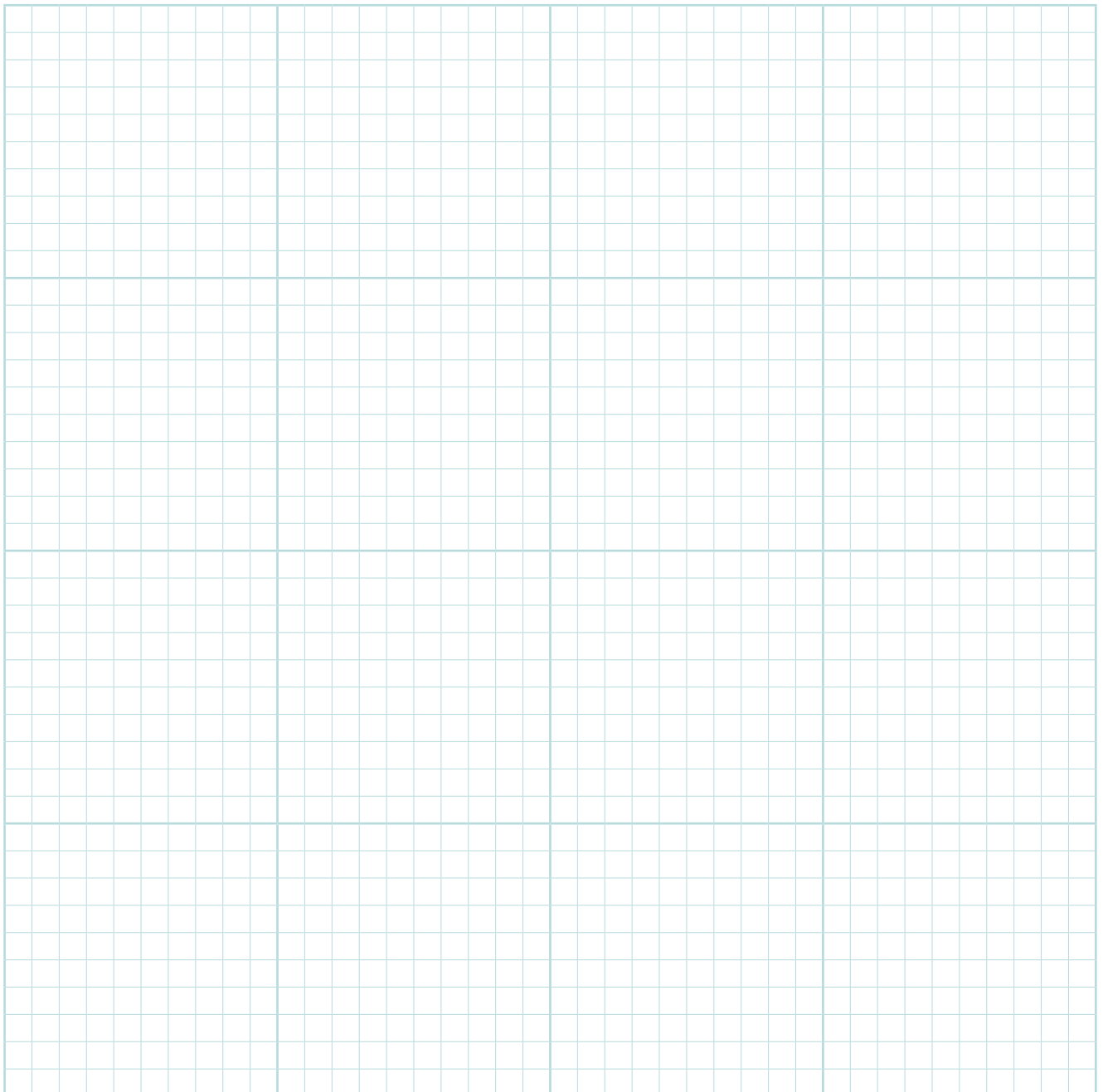

Plan Your Layout

Where to use Filler Panels and End Panels in your Modular Laundry

16mm Filler Panels:

Use if a cabinet is against a wall or between walls. Filler panels allow you to plumb up walls and work around architraves. Tall 16mm filler panels can also be used as kickboard fronts if you want a continuous look.

100mm Wide Filler Panels:

Use if your filler panel needs to be wider than 16mm.

End Panels:

End panels are needed when the washing machine or dryer is at the end of the run. Please note our Modular Laundry cabinets are designed with finished ends attached.

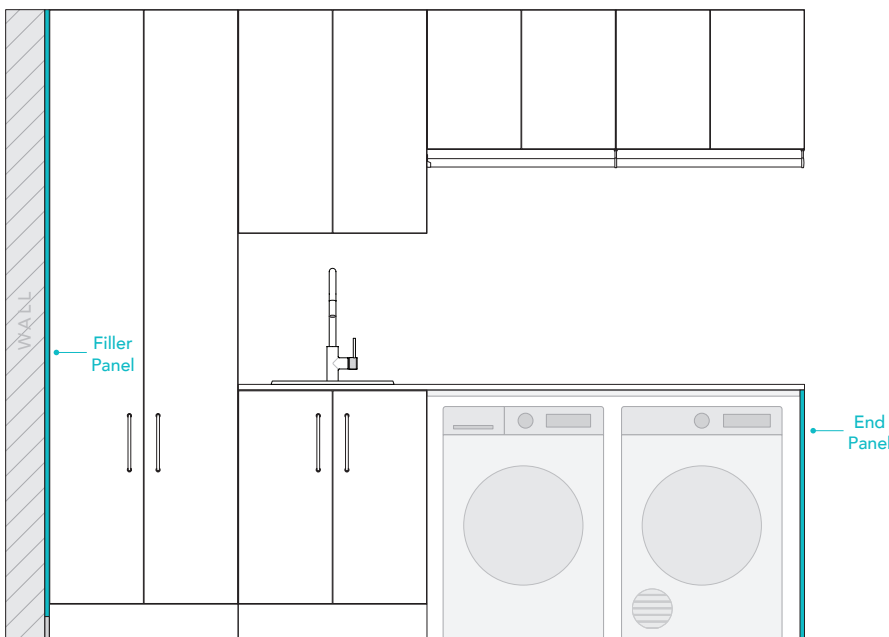

A note on Easy Installation

Our modular laundry cabinets are fully built and arrive to you ready for easy installation.

We recommend installation by a qualified builder or tradie.

Scan QR code to view the Laundry Installation & Warranty Booklet or go to www.adpaustralia.com.au/installation-warranty



Individual cabinets arrive fully assembled and ready for easy install.



Adjustable plastic feet are provided for adjusting floor cabinet levels, up to 30mm up or down.

Front feet are simply adjusted by hand. Back feet are adjusted with a screw driver through an easy access hole.

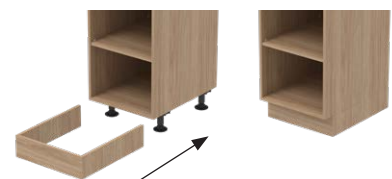

All base cabinets are supplied with a slide in kickboard for easy installation.

Select Finishes

Choose Your Style

Choose your laundry cabinet style and select your cabinet and benchtop finishes plus your laundry extras. All of our modular cabinets, benchtops and accessories are available in every single style.

Pure Silk Cabinets

\$\$\$

The budget friendly style.

Flat cabinet fronts available in all ADP Silk cabinet finishes with a fresh white interior.

Page 10

Decor Cabinets

\$\$\$

The designer look at an affordable price.

Flat cabinet fronts in all ADP woodgrain and polyurethane finishes. Choose from fresh white or premium graphite interior.

Page 12

Classic Cabinets

\$\$\$

Timeless design for the forever home.

Select from a variety of routed cabinet front designs in matte polyurethane. Choose from fresh white or premium graphite interior.

Page 14



Cabinet Finishes
Page 40



Benchtop Finishes
Page 44



Tapware, Sinks & Accessories
Page 30

Order In Store

Order Checklist

- Complete detailed drawing of your laundry design.
- Check if you need filler panels or an end panel, ensure you have accounted for these in your laundry design.
- Check measure your laundry appliances to ensure they will fit in your laundry design.
- Select all cabinet and benchtops finishes, sink, tapware and laundry accessories.
- Take your detailed drawing to retail store to complete an order form and place order (scan QR code below to find store)

Ready to order

Once you have checked off everything in the above list you are now ready to order your dream laundry! Scan the QR code or visit www.adpastralia.com.au/where-to-buy to find a store near you and place your laundry order.



Where to buy

What happens next?

- Once your order is placed through a retail store, ADP will check order details and draw up order.
- We will then send the final drawing to double check details before signing off the design.
- Once approved, we will begin manufacturing and preparing your order which is then shipped to store.
- Please check everything has been received and is exactly what you ordered. Your qualified installer is now ready to install your laundry.

Choose Your Style | Pure Silk

\$\$\$

The budget friendly style.

Cabinet Finishes

Flat cabinet fronts available in all ADP Silk cabinet finishes only
See page 40 for finishes



Benchtop (if required)

20mm benchtop (sold separately)
Upgrade to 40, 60 or 90mm mitred benchtop for a \$409.00 upgrade fee
Available in Cherry Pie Premium Solid Surface
See page 44 for finishes
Available without benchtop, please discuss options with your local stone mason

Interior & Hardware



Fresh white interior
ADP pressed metal drawers in white with soft-close adapter
Soft-close doors
For graphite interior, choose Decor cabinets

Sink Options

Choose from all ADP Sinks
Sold separately
See page 30

Handle Options

Bevel-grip finger pull or choice of handle options
See page 38
Additional charges apply for premium handles

The ADP Difference

- Australian Made
- All cabinets are made from Australian board from sustainably managed forests
- Most cabinets can be shrunk down between sizes to suit the width you need
- 10 Year Warranty on Cabinetry & Benchtops

Get the look | Modern Fresh White

For more Inspiration & Style Guides see page 48

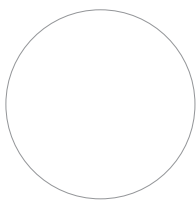

Pure Silk Cabinets
Polar White Silk Matte
Bevel-grip finger pull



20mm Alabaster
Cherry Pie Benchtop



Pure Silk Hamper Cabinet
Fresh White interior



Hanging Rail
Matte Black

Organisation Tip

Add multiple laundry hampers if space allows. They are a life-saver if you have a small laundry and want to avoid a cluttered floor. Add a rail underneath the wall cabinets to create a compact hanging space.

Maximise Storage

Choose King Height tall cabinets if your ceiling height allows and pair floor cabinets with wall cabinets to utilise as much vertical storage space as possible.

DESIGNER TIPS

TOTAL COST*
Pure Silk
\$8,625
Decor \$9,285
Classic \$10,715

*Price includes cabinetry, benchtop, sink, tapware & accessories.
See page 47 for Modular Parts List



Matte Black
Hanging Rail

Select from the ADP
handle range, or
choose your own



3 x 450mm Floor
Cabinets with Hamper



Choose Your Style | Decor

\$\$\$

The designer look at an affordable price.

Cabinet Finishes

Flat cabinet fronts available in all ADP cabinet finishes

See page 40 for finishes

Benchtop (if required)

20mm benchtop (sold separately)

Upgrade to 40, 60 or 90mm mitred benchtop for a \$409.00 upgrade fee

Available in Cherry Pie Premium Solid Surface

See page 44 for finishes

Available without benchtop, please discuss options with your local stone mason

Interior & Hardware



Choose from Fresh White or Premium Graphite interior

ADP Deluxe soft-close drawers with solid sides

Soft-close doors

Sink Options

Choose from all ADP Sinks

Sold separately

See page 30

Handle Options

Bevel-grip finger pull or choice of handle options

See page 38

Additional charges apply for premium handles

The ADP Difference

- Australian Made
- All cabinets are made from Australian board from sustainably managed forests
- Most cabinets can be shrunk down between sizes to suit the width you need
- 10 Year Warranty on Cabinetry & Benchtops

Get the look | Industrial Luxe

For more Inspiration & Style Guides see page 48



Estella Oak Woodmatt Cabinet Finish Bevel-grip finger pull



40mm Alabaster Cherry Pie Benchtop



Bellevue Small Rectangular Sink, Matte Black



Soul Pull Out Mixer Matte Black

Maximise Storage & Functionality

If ceiling heights allow, choose King Height tall cabinets to maximise storage. Utilise open shelves for easy-to-reach everyday items.

Style tip

Elevate your design with a 40mm mitred benchtop. Our Alabaster Premium Cherry Pie benchtop pairs beautifully with the Estella Oak cabinet finish for a timeless, luxe style. The contrasting tones in the finishes, tiles, tapware and sink add visual interest.

DESIGNER TIPS

TOTAL COST*

Decor \$6,437

Pure Silk \$6,027
Classic \$7,027

*Price includes cabinetry, benchtop, sink, tapware & accessories.

See page 47 for Modular Parts List



Choose King Height cabinets to maximise storage when ceiling height allows

Utilise open-shelves for easy to reach items



Upgrade to 40, 60 or 90mm mitred benchtop for \$409

Choose Your Style | Classic

\$\$\$

Timeless design for the forever home.

Routed Front Options

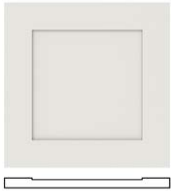

Shallow Shaker

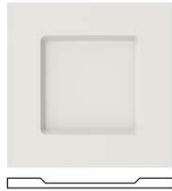

Deep Shaker



Barn Door

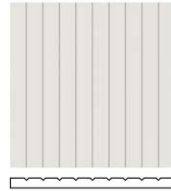

Narrow V-Groove

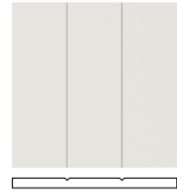

Wide V-Groove

Polyurethane Cabinet Finish



Matte White



Matte Feather Grey



Matte Milton
Moon Grey



Matte Black
(Excludes Barn Door profile)

Please note all polyurethane end panels are in matching silk board

Sink Options

Choose from all ADP Sinks

Sold separately

See page 30

Benchtop (if required)

20mm benchtop (sold separately)

Upgrade to 40, 60 or 90mm mitred benchtop for a \$409.00 upgrade fee

Available in Cherry Pie Premium Solid Surface

See page 44 for finishes

Available without benchtop, please discuss options with your local stone mason

Handle Options

Bevel-grip finger pull or choice of handle options

See page 38

Additional charges apply for premium handles

Interior & Hardware



Choose from Fresh White or Premium Graphite interior

ADP Deluxe soft-close drawers with solid sides

Soft-close doors

The ADP Difference

Australian Made

All cabinets are made from Australian board from sustainably managed forests

Most cabinets can be shrunk down between sizes to suit the width you need

10 Year Warranty on Cabinetry & Benchtops

Get the look | Timeless Warmth

For more Inspiration & Style Guides see page 48



Classic Shallow Shaker routed cabinets
Feather Grey Polyurethane
Tan Leather Pull



20mm Grey Travertine
Cherry Pie Benchtop



Bellevue Round Sink
Matte White



Soul Pull Out Mixer
Brushed Copper

*Price includes cabinetry, benchtop, sink, tapware & accessories.

See page 47 for Modular Parts List

TOTAL COST*
Classic
\$7,089
Pure Silk: \$5,659
Decor: \$6,179

Classic cabinets
are available in 4
polyurethane colours

Choose from 5
different routed
front design options



Mix Your Styles

Mix & match between Pure Silk, Decor and Classic cabinet styles and finishes to create interest and a sense of balance within the space.

Get the look | Contemporary Boho

For more
Inspiration & Style Guides
see page 48



Premium features

Take your laundry to the next level by choosing a premium graphite interior.

Create warmth and interest

A warm-toned woodgrain cabinet finish pairs perfectly with textured v-groove wall cabinets. A matte white sink and handles, in addition to brass tapware and accessories, creates a laundry filled with warmth and interest.

DESIGNER TIPS



*Price includes cabinetry, benchtop, sink, tapware & accessories.

See page 47 for Modular Parts List



Decor Cabinets in Boston Oak Woodmatt

Classic Cabinets with Wide V-Groove Routing



Hamper cabinets available in Fresh White or Premium Graphite interior



Choose from the full ADP standard and premium handle range

Floor Cabinets Bevel-Grip Finger Pull or Handle options



Floor Cabinet 300mm - 1 Door

Pure Silk	PFD30	\$309.00
Decor	DFD30	\$369.00
Classic	CFD30	\$419.00

Door can be Left or Right Hand hinged



Floor Cabinet 450mm - 1 Door

Pure Silk	PFD45	\$369.00
Decor	DFD45	\$419.00
Classic	CFD45	\$519.00

Door can be Left or Right Hand hinged



Floor Cabinet 600mm - 1 Door

Pure Silk	PFD60	\$419.00
Decor	DFD60	\$469.00
Classic	CFD60	\$579.00

Door can be Left or Right Hand hinged



Floor Cabinet 675mm - 2 Doors

Pure Silk	PFD67	\$439.00
Decor	DFD67	\$489.00
Classic	CFD67	\$679.00



Floor Cabinet 900mm - 2 Doors

Pure Silk	PFD90	\$539.00
Decor	DFD90	\$599.00
Classic	CFD90	\$729.00



Floor Cabinet 1200mm - 2 Doors

Pure Silk	PFD12	\$679.00
Decor	DFD12	\$729.00
Classic	CFD12	\$839.00



Drawer Cabinet 300mm - 3 Drawers

Pure Silk	PFA30	\$469.00
Decor	DFA30	\$589.00
Classic	CFA30	\$739.00



Drawer Cabinet 450mm - 3 Drawers

Pure Silk	PFA45	\$519.00
Decor	DFA45	\$639.00
Classic	CFA45	\$799.00



Drawer Cabinet 600mm - 3 Drawers

Pure Silk	PFA60	\$579.00
Decor	DFA60	\$689.00
Classic	CFA60	\$849.00



Drawer Cabinet 675mm - 3 Drawers

Pure Silk	PFA67	\$599.00
Decor	DFA67	\$709.00
Classic	CFA67	\$869.00



Drawer Cabinet 900mm - 3 Drawers

Decor	DFA90	\$939.00
Classic	CFA90	\$1,099.00



Drawer Cabinet 1200mm - 3 Drawers

Decor	DFA12	\$1,259.00
Classic	CFA12	\$1,419.00

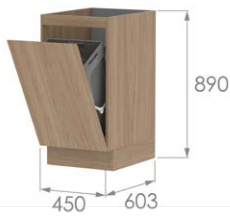

Floor Cabinet 450mm - With Hamper

Pure Silk	PFH45	\$659.00
Decor	DFH45	\$729.00
Classic	CFH45	\$889.00



Floor Cabinet 450mm - 2 Drawers with Swivel Ironing Board

Pure Silk	PF145	\$659.00
Decor	DF145	\$729.00
Classic	CF145	\$889.00

● = This cabinet cannot be customised, the dimensions are fixed



Laundry Hamper Floor Cabinet
Tidy up that messy floor-drobe

Swivel Ironing Board Floor Cabinet
Perfect for those ironing emergencies!

Wall Cabinets Finger Pull only (no handles)

300mm High Open Shelves - Pair with 300 or 500mm high Wall Cabinets

Excludes polyurethane finishes on all Open Shelf cabinets

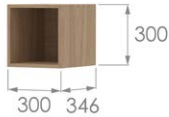

Open Shelf 300mm

Pure Silk	PWS330	\$239.00
Decor	DWS330	\$259.00



Open Shelf 450mm

Pure Silk	PWS345	\$259.00
Decor	DWS345	\$279.00



Open Shelf 600mm

Pure Silk	PWS360	\$289.00
Decor	DWS360	\$309.00



Open Shelf 675mm

Pure Silk	PWS367	\$309.00
Decor	DWS367	\$329.00



Open Shelf 900mm

Pure Silk	PWS390	\$369.00
Decor	DWS390	\$389.00

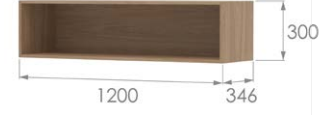

Open Shelf 1200mm

Pure Silk	PWS312	\$419.00
Decor	DWS312	\$439.00

300mm High - Pair with Open Shelves or Hanging Rails



Wall Cabinet 300mm - 1 Door

Pure Silk	PWD330	\$259.00
Decor	DWD330	\$279.00
Classic	CWD330	\$329.00

Door can be Left or Right Hand hinged

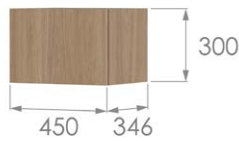

Wall Cabinet 450mm - 1 Door

Pure Silk	PWD345	\$289.00
Decor	DWD345	\$309.00
Classic	CWD345	\$369.00

Door can be Left or Right Hand hinged

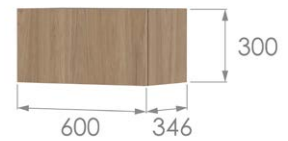

Wall Cabinet 600mm - 1 Door

Pure Silk	PWD360	\$309.00
Decor	DWD360	\$329.00
Classic	CWD360	\$419.00

Door can be Left or Right Hand hinged



Wall Cabinet 675mm - 2 Doors

Pure Silk	PWD367	\$369.00
Decor	DWD367	\$389.00
Classic	CWD367	\$489.00



Wall Cabinet 900mm - 2 Doors

Pure Silk	PWD390	\$419.00
Decor	DWD390	\$439.00
Classic	CWD390	\$539.00



Wall Cabinet 1200mm - 2 Doors

Pure Silk	PWD312	\$519.00
Decor	DWD312	\$539.00
Classic	CWD312	\$649.00

500mm High - To suit **2.1m** Ceiling and above



Wall Cabinet 300mm - 1 Door

Pure Silk	PWD530	\$309.00
Decor	DWD530	\$329.00
Classic	CWD530	\$389.00

Door can be Left or Right Hand hinged

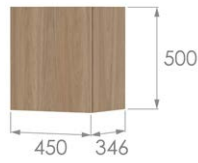

Wall Cabinet 450mm - 1 Door

Pure Silk	PWD545	\$349.00
Decor	DWD545	\$369.00
Classic	CWD545	\$419.00

Door can be Left or Right Hand hinged



Wall Cabinet 600mm - 1 Door

Pure Silk	PWD560	\$369.00
Decor	DWD560	\$389.00
Classic	CWD560	\$469.00

Door can be Left or Right Hand hinged



Wall Cabinet 675mm - 2 Doors

Pure Silk	PWD567	\$419.00
Decor	DWD567	\$439.00
Classic	CWD567	\$539.00



Wall Cabinet 900mm - 2 Doors

Pure Silk	PWD590	\$469.00
Decor	DWD590	\$489.00
Classic	CWD590	\$599.00



Wall Cabinet 1200mm - 2 Doors

Pure Silk	PWD512	\$579.00
Decor	DWD512	\$599.00
Classic	CWD512	\$699.00

800mm High - To suit **2.4m** Ceiling and above



Wall Cabinet 300mm - 1 Door

Pure Silk	PWD830	\$369.00
Decor	DWD830	\$389.00
Classic	CWD830	\$439.00

Door can be Left or Right Hand hinged



Wall Cabinet 450mm - 1 Door

Pure Silk	PWD845	\$399.00
Decor	DWD845	\$449.00
Classic	CWD845	\$469.00

Door can be Left or Right Hand hinged

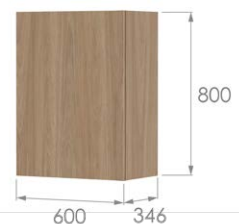

Wall Cabinet 600mm - 1 Door

Pure Silk	PWD860	\$419.00
Decor	DWD860	\$469.00
Classic	CWD860	\$519.00

Door can be Left or Right Hand hinged

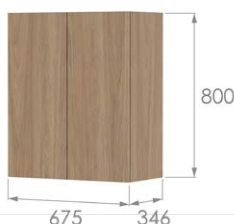

Wall Cabinet 675mm - 2 Doors

Pure Silk	PWD867	\$469.00
Decor	DWD867	\$519.00
Classic	CWD867	\$599.00



Wall Cabinet 900mm - 2 Doors

Pure Silk	PWD890	\$519.00
Decor	DWD890	\$559.00
Classic	CWD890	\$649.00



Wall Cabinet 1200mm - 2 Doors

Pure Silk	PWD812	\$629.00
Decor	DWD812	\$659.00
Classic	CWD812	\$749.00

Tall Cabinets Push-to-open or Handle options

Standard Height 2050mm - To suit **2.1m** Ceiling and above

Note: All shelves are removable to allow for extra room to fit larger items such as a vaccuum, mop or broom.



Tall Cabinet 450mm - Open Shelves*

Pure Silk	PTSS45	\$679.00
Decor	DTSS45	\$889.00

**Excludes polyurethane finishes on all Open Shelf cabinets*



Tall Cabinet 600mm - Open Shelves*

Pure Silk	PTSS60	\$729.00
Decor	DTSS60	\$939.00



Tall Cabinet 900mm - Open Shelves*

Pure Silk	PTSS90	\$839.00
Decor	DTSS90	\$1,049.00



Tall Cabinet 450mm - 1 Door

Pure Silk	PTDS45	\$679.00
Decor	DTDS45	\$889.00
Classic	CTDS45	\$1,099.00

Door can be Left or Right Hand hinged



Tall Cabinet 600mm - 1 Door

Pure Silk	PTDS60	\$729.00
Decor	DTDS60	\$939.00
Classic	CTDS60	\$1,149.00



Tall Cabinet 900mm - 2 Doors

Pure Silk	PTDS90	\$839.00
Decor	DTDS90	\$1,049.00
Classic	CTDS90	\$1,359.00



Tall Cabinet 450mm - 1 Door with Broom Split

Pure Silk	PTBS45	\$679.00
Decor	DTBS45	\$889.00
Classic	CTBS45	\$1,099.00

Door can be Left or Right Hand hinged



Tall Cabinet 600mm - 1 Door with Broom Split

Pure Silk	PTBS60	\$729.00
Decor	DTBS60	\$939.00
Classic	CTBS60	\$1,149.00



Tall Cabinet 900mm - 2 Doors with Broom Split

Pure Silk	PTBS90	\$839.00
Decor	DTBS90	\$1,049.00
Classic	CTBS90	\$1,359.00

King Height 2250mm - To suit **2.4m** Ceiling and above

Note: All shelves are removable to allow for extra room to fit larger items such as a vaccuum, mop or broom.



Tall Cabinet 450mm - Open Shelves*

Pure Silk	PTSK45	\$729.00
Decor	DTSK45	\$939.00



Tall Cabinet 600mm - Open Shelves*

Pure Silk	PTSK60	\$789.00
Decor	DTSK60	\$999.00



Tall Cabinet 900mm - Open Shelves*

Pure Silk	PTSK90	\$889.00
Decor	DTSK90	\$1,099.00

*Excludes polyurethane finishes on all Open Shelf cabinets



Tall Cabinet 450mm - 1 Door

Pure Silk	PTDK45	\$729.00
Decor	DTDK45	\$939.00
Classic	CTDK45	\$1,149.00

Door can be Left or Right Hand hinged



Tall Cabinet 600mm - 1 Door

Pure Silk	PTDK60	\$789.00
Decor	DTDK60	\$999.00
Classic	CTDK60	\$1,209.00



Tall Cabinet 900mm - 2 Doors

Pure Silk	PTDK90	\$889.00
Decor	DTDK90	\$1,099.00
Classic	CTDK90	\$1,419.00



Tall Cabinet 450mm - 1 Door with Broom Split

Pure Silk	PTBK45	\$729.00
Decor	DTBK45	\$939.00
Classic	CTBK45	\$1,149.00

Door can be Left or Right Hand hinged



Tall Cabinet 600mm - 1 Door with Broom Split

Pure Silk	PTBK60	\$789.00
Decor	DTBK60	\$999.00
Classic	CTBK60	\$1,209.00



Tall Cabinet 900mm - 2 Doors with Broom Split

Pure Silk	PTBK90	\$889.00
Decor	DTBK90	\$1,099.00
Classic	CTBK90	\$1,419.00

Corner Cabinets Includes corner filler

Floor Corner Cabinets



Top View

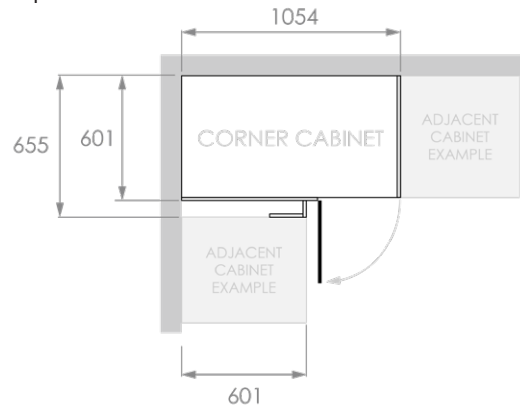

Corner Floor Cabinet - Left or Right

Pure Silk	PFC	\$519.00
Decor	DFC	\$589.00
Classic	CFC	\$739.00

Wall Corner Cabinets



Wall Corner Cabinet - 300mm High,
Left or Right Hand Hinged

Pure Silk	PWC3	\$419.00
Decor	DWC3	\$439.00
Classic	CWC3	\$489.00



Wall Corner Cabinet - 500mm High,
Left Or Right Hand Hinged

Pure Silk	PWC5	\$469.00
Decor	DWC5	\$489.00
Classic	CWC5	\$539.00



Wall Corner Cabinet - 800mm High,
Left or Right Hand Hinged

Pure Silk	PWC8	\$519.00
Decor	DWC8	\$559.00
Classic	CWC8	\$599.00

Top View

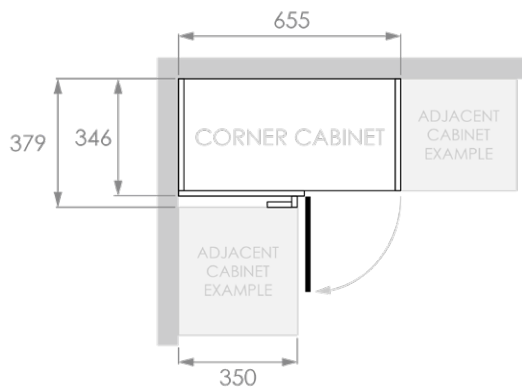

Washing Machine Surrounds & Rails



Stacked Washing Machine Surround (Standard Height)

Pure Silk	PTWS	\$679.00
Decor	DTWS	\$839.00
Classic	CTWS	\$939.00



Stacked Washing Machine Surround (King Height)

Pure Silk	PTWK	\$729.00
Decor	DTWK	\$889.00
Classic	CTWK	\$999.00

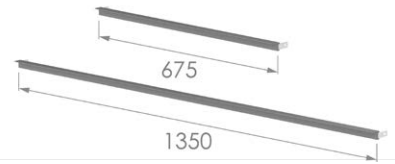

Benchtop Support Rail (For washing machine and dryer)

675mm Wide	BTS67	\$99.00
<i>Suits one appliance</i>		
1350mm Wide	BTS13	\$199.00
<i>Suits two appliances</i>		

● = This cabinet cannot be customised, the dimensions are fixed



Filler & End Panels

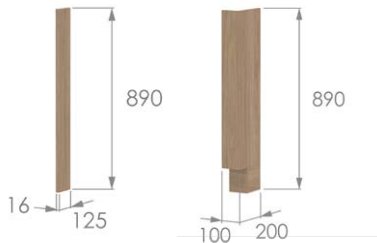

Floor Filler Panels - 890mm High

16mm Wide	FF16	\$49.00
100mm Wide	FF100	\$99.00

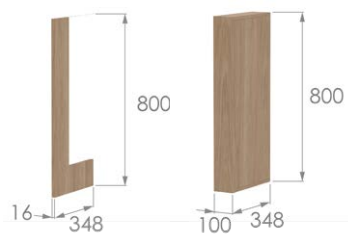

Wall Filler Panels - 800mm High

16mm Wide	WF16	\$49.00
100mm Wide	WF100	\$119.00

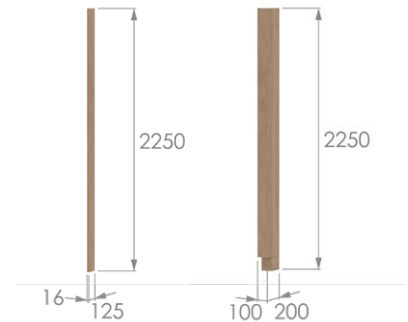

Tall Filler Panels - 2250mm High

16mm Wide	TF16	\$99.00
100mm Wide	TF100	\$149.00

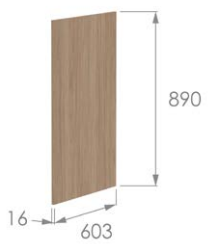

Floor End Panel

Floor End Panel	FEP	\$149.00
-----------------	-----	-----------------

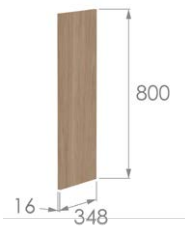

Wall End Panels

Wall End Panel	WEP	\$99.00
----------------	-----	----------------



Tall End Panel

Tall End Panel	TEP	\$249.00
----------------	-----	-----------------

Where to use Filler Panels and End Panels

16mm Filler Panels:

Use if a cabinet is against a wall or between walls. Filler panels allow you to plumb up walls and work around architraves. *Tall 16mm filler panels can also be used as kickboard fronts if you want a continuous look.*

100mm Wide Filler Panels:

Use if your filler panel needs to be wider than 16mm.

End Panels:

End panels are needed when the washing machine or dryer is at the end of the run. Please note our Modular Laundry cabinets are designed with finished ends attached.

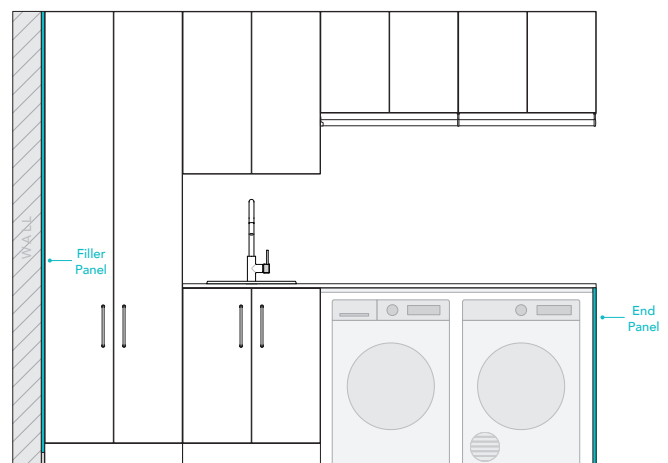

Benchtop (sold with laundry cabinetry only)

20mm Cherry Pie Benchtop per lineal metre (Minimum 1m, Maximum 2.2m)*
Includes Sink cut out for ADP Sinks only, see page 30

CPTOP

\$649.00 per lineal metre

Upgrade to 40, 60 or 90mm mitred benchtop

\$409.00 (one off fee)

*Due to freight restrictions, the maximum benchtop length we can ship is 2.2m. You may join two pieces together to achieve a longer length.
Benchtop must be purchased with a corresponding sized Laundry and cannot be purchased on its own.

Custom Option Pricing

Shrink cabinet width in between standard sizes

Price as next standard size up. Eg. 800mm would be priced as a 900mm

Special Colour - Laminex or Polytec

From: \$345.00 (contact ADP to confirm availability)

No custom polyurethane colours available.

Custom Width Cabinets

Most of our modular cabinets can be shrunk down in width between standard sizes for wall-to-wall applications.

How to make the most of customisable widths

Use our standard sized modular cabinet to fill the majority of your laundry, then order a custom width cabinet to fit the remaining space perfectly.

CUSTOM OPTIONS



All-In-One Sink Cabinet

Standalone sink cabinet including benchtop and choice of Clovelly stainless steel sink.

Styles & Finish Options

Available in Pure Silk, Decor or Classic styles and finishes

For styles see page 10

For finishes see page 40

Benchtop (included)

20mm benchtop

Upgrade to 40, 60 or 90mm mitred benchtop for a \$409.00 upgrade fee

Available in Cherry Pie Premium Solid Surface

See page 44 for colours

Interior & Hardware



Choose from Fresh White or Premium Graphite interior*

Soft-close doors with adjustable internal shelf

*Pure Silk available with Fresh White interior only, for Graphite choose Decor

Overall Dimensions

900 (W) x 910 (H) x 610 (D) mm

Handle Options

Bevel-grip finger pull or choice of handle options

See page 38

Additional charges apply for premium handles

The ADP Difference



Australian Made



All cabinets are made from Australian board from sustainably managed forests



10 Year Warranty on Cabinetry & Benchtops

Sink Options (included)

Choice of Clovelly Sinks - see below. See pages 30 for sink details.

Drop-In or Under-Counter sink mounting

Sinks available Centre, Left or Right position, specify on order form. *Clovelly Universal Sink Set available centre only.*



With Clovelly Round Sink

Pure Silk	PP90R	\$889.00
Decor	DP90R	\$939.00
Classic	CP90R	\$1,469.00



With Clovelly Small Rectangular Sink

Pure Silk	PP90S	\$999.00
Decor	DP90S	\$1,099.00
Classic	CP90S	\$1,519.00



With Clovelly Large Rectangular Sink

Pure Silk	PP90L	\$1,049.00
Decor	DP90L	\$1,149.00
Classic	CP90L	\$1,569.00



With Clovelly Universal Sink Set*

Pure Silk	PP90U	\$1,209.00
Decor	DP90U	\$1,419.00
Classic	CP90U	\$1,779.00

*Includes main sink, inner sink, tray drainer and roll up dish drainer.

Note - Tapware and appliances not included.

20mm benchtop included
Upgrade to 40, 60 or 90mm
mitred benchtop for \$409.00

TOTAL COST
Classic
\$2,376*
Pure Silk: \$2,055*
Decor: \$1,846*

Available in Pure Silk,
Decor and Classic
styles and finishes



Sink included,
choose from the
Clovelly range



Choose from Fresh White
or Graphite interior with
adjustable internal shelf

Clovelly Sinks | 304 Grade Stainless Steel

Features

- 304 Grade Stainless Steel
- 1.5mm gauge (Round Sink 5mm)
- Includes stainless steel basket waste
- Drop In or Under-Counter available

15 15 Year Warranty on Clovelly Sinks

Clovelly Round Sink

Capacity: 20L
Minimum Cabinet width:
Drop In 480mm / Under-Counter 550mm
SINKCLO430SS
From: **\$209.00**

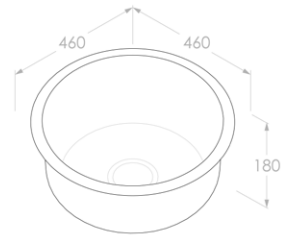

Clovelly Small Rectangular Sink

Capacity: 25L
Minimum Cabinet width:
Drop In 450mm / Under-Counter 550mm
SINKCLO3844SS
From: **\$399.00**

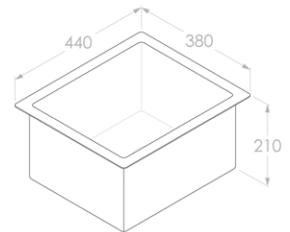

Clovelly Large Rectangular Sink

Capacity: 38L
Minimum Cabinet width:
Drop In 590mm / Under-Counter 700mm
SINKCLO5444SS
From: **\$469.00**

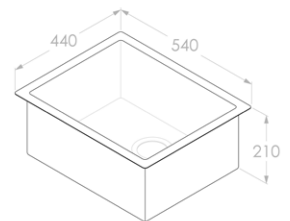

Clovelly Universal Sink Set

Minimum Cabinet width: 900mm
SINKCLOM8244SS
From: **\$839.00**



Universal Sink
820 x 440 x 250mm
63L Capacity

Inner Sink
377 x 377 x 150mm
17L Capacity

Tray Drainer
405 x 438mm
Black Plastic

Roll Up Dish Drainer
377 x 377 x 10mm
Black Plastic

Clovelly Universal Sink Set
Bloom Sink Mixer, Light Brushed Brass



Clovelly Small Rectangular Sink
Soul Sink Mixer, Brushed Nickel



Clovelly Round Sink
Eternal Sink Mixer, Brushed Nickel



Bellevue Sinks | Granite Composite

Features

- Finely textured non-porous finish
- Composed of 80% quartz sand and 20% acrylic resin
- Includes stainless steel basket waste
- Drop In application only

10 10 Year Warranty on Bellevue Sinks

Bellevue Round Sink

440 (Dia) x 200 (H) mm
Capacity: 23L
Minimum Cabinet width: 490mm
Matte Black: SINKBEL435BK
Matte White: SINKBEL435WHT
From: \$419.00



Bellevue Small Rectangular Sink

455 (L) x 405 (W) 220 (H) mm
Capacity: 22L
Minimum Cabinet width: 490mm
Matte Black: SINKBEL4641BK
Matte White: SINKBEL4641WHT
From: \$449.00



Bellevue Large Rectangular Sink

790 (L) x 460 (W) 220 (H) mm
Capacity: 43L
Minimum Cabinet width: 850mm
Matte Black: SINKBEL7945BK
Matte White: SINKBEL7945WHT
From: \$629.00



Bellevue Round Sink, Matte White
Laundry designed by Reno Diary



Bellevue Small Rectangular Sink, Matte Black
Soul Pull Out Sink Mixer, Matte Black



Bellevue Large Rectangular Sink, Matte White
Soul Pull Out Sink Mixer, Brushed Brass

Tapware



Soul Kitchen & Laundry Mixer

		RRP From:
Soul:		
Chrome	JTAPKSOUCP	\$239.00
Soul Groove:		
Brushed Brass	JTAPKSOUBB	\$279.00
Brushed Copper	JTAPKSOUBCO	\$279.00
Brushed Nickel	JTAPKSOUNK	\$279.00
Matte Black	JTAPKSOUBA	\$279.00
Matte White	JTAPKSOUWA	\$279.00



Soul Pull Out Kitchen & Laundry Mixer (dual spray)

		RRP From:
Soul:		
Chrome	JTAPKPSOUCP	\$309.00
Soul Groove:		
Brushed Brass	JTAPKPSOUBB	\$349.00
Brushed Copper	JTAPKPSOUBCO	\$349.00
Brushed Nickel	JTAPKPSOUNK	\$349.00
Matte Black	JTAPKPSOUBA	\$349.00
Matte White	JTAPKPSOUWA	\$349.00



Eternal Kitchen & Laundry Mixer

		RRP From:
Chrome	JTAPKSOECP	\$259.00
Brushed Brass	JTAPKSOEBB	\$309.00
Brushed Copper	JTAPKSOEBCO	\$309.00
Brushed Nickel	JTAPKSOENK	\$309.00
Matte Black	JTAPKSOEBA	\$309.00



Eternal Pull Out Kitchen & Laundry Mixer (dual spray)

		RRP From:
Chrome	JTAPKPSOEC	\$329.00
Brushed Brass	JTAPKPSOEBB	\$379.00
Brushed Copper	JTAPKPSOEBCO	\$379.00
Brushed Nickel	JTAPKPSOENK	\$379.00
Matte Black	JTAPKPSOEBA	\$379.00



Bloom Kitchen & Laundry Mixer

		RRP From:
Chrome	JTAPKBLMCP	\$399.00
Light Brushed Brass	JTAPKBLMBB	\$479.00
Warm Brushed Nickel	JTAPKBLMNK	\$479.00
Brushed Gunmetal	JTAPKBLMBGM	\$479.00
Matte Black	JTAPKBLMBA	\$479.00



Bloom Pull Out Kitchen & Laundry Mixer (single spray)

		RRP From:
Chrome	JTAPKPBLMCP	\$499.00
Light Brushed Brass	JTAPKPBLMBB	\$579.00
Warm Brushed Nickel	JTAPKPBLMNK	\$579.00
Brushed Gunmetal	JTAPKPBLMBGM	\$579.00
Matte Black	JTAPKPBLMBA	\$579.00



Bloom Pull Out Kitchen Mixer, Light Brushed Brass
Bellevue Round Sink, Matte White
Laundry designed by Haas.

SAMSUNG

Accessories

Bin

Push button lid
Stainless steel housing
Keyhole fixing

3L: FITTADPPTOBIN3L
From: **\$49.00**
6L: FITTADPPTOBIN6L
From: **\$69.00**



Power Point

White
PWRGPO2G10A250W
Anthracite
PWRGPO2G10A250W
From: **\$60.00**



Chrome Hanging Rail*

LDRYRAILCPLM

From: **\$29.00 per lineal metre**

Cabinet Above End Flange - FITTWDEFSUPOV30
From: **\$9.00 each**

Cabinet Beside End Flange - FITTWDFGSUPOV30
From: **\$9.00 each**

Centre Flange - FITTWDCPSUPOV30
From: **\$13.00 each**



With Cabinet Above End Flanges

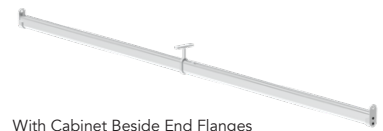

With Cabinet Beside End Flanges

Matte Black Hanging Rail*

LDRYRAILBKLM

From: **\$39.00 per lineal metre**

Cabinet Above End Flange - FITTWDEFSUPOB30
From: **\$10.00 each**

Cabinet Beside End Flange - FITTWDFGSUPOB30
From: **\$10.00 each**

Centre Flange - FITTWDCPSUPOB30
From: **\$15.00 each**



With Cabinet Above End Flanges



With Cabinet Beside End Flanges

Cabinet Above End Flange attaches to cabinet above. Cabinet Beside End Flange attaches to cabinet beside.
It is recommended that you order a Centre Flange for rails over 1m in length.
*Not for individual sale, sold with laundry cabinetry only.

Soul Single Towel Rail

600mm

Chrome: From: **\$129.00**

All other finishes: From: **\$189.00**

900mm

Chrome: From: **\$169.00**

All other finishes: From: **\$229.00**



Soul Accessories

Robe Hook

Chrome: From: **\$79.00**

All other finishes: From: **\$109.00**

Hand Towel Ring

Chrome: From: **\$99.00**

All other finishes: From: **\$139.00**



Eternal Single Towel Rail

600mm

Chrome: From: **\$139.00**

All other finishes: From: **\$199.00**

900mm

Chrome: From: **\$189.00**

All other finishes: From: **\$249.00**



Eternal Accessories

Robe Hook

Chrome: From: **\$89.00**

All other finishes: From: **\$119.00**

Hand Towel Ring

Chrome: From: **\$109.00**

All other finishes: From: **\$149.00**



For Soul & Eternal Accessory codes, see website - www.adpastralia.com.au

ELECTRIC CLOTHES HANGER

Perfect for apartment living and small spaces

Material	Silver Aluminium.
4 x Extendable Rods	Minimum to Maximum: 1200 - 2200mm.
Length to Drop	1300mm.
Load Capacity	35kg.
LED Panel Light	Remote control operated.
Installation	Ceiling mounted. Must be installed by a qualified electrician.

FITTPARA120SLVR
 From: \$1,049.00



Scan QR code to see video of Electric Clothes Hanger in operation

Handles

Add any handle from the below range at no extra cost to applicable cabinets.

To purchase individually see prices below.

Handles are position vertical on floor and tall cabinets, horizontal on drawer cabinets.

Bridge

Available in Chrome

Projection 30mm

Hole centres	Individual Price
--------------	------------------

96mm	\$19.00 ea
------	-------------------

224mm	\$29.00 ea
-------	-------------------



Round Cross Bar

Available in Matte White, Chrome, Brushed Nickel, Matte Black, Polished Rose Gold

Projection 33mm

Hole centres	Individual Price
--------------	------------------

96mm	\$19.00 ea
------	-------------------

224mm	\$29.00 ea
-------	-------------------

544mm	\$49.00 ea
-------	-------------------



Flat-D

Available in Chrome

Projection 28mm

Hole centres	Individual Price
--------------	------------------

96mm	\$19.00 ea
------	-------------------

224mm	\$29.00 ea
-------	-------------------



Link

Available in Chrome

Projection 30mm

Hole centres	Individual Price
--------------	------------------

96mm	\$19.00 ea
------	-------------------

224mm	\$29.00 ea
-------	-------------------



Sydney

Available in Chrome

Projection 28mm

Hole centres	Individual Price
--------------	------------------

96mm	\$19.00 ea
------	-------------------

224mm	\$29.00 ea
-------	-------------------



Plus

Available in Chrome

Projection 25mm

Hole centres	Individual Price
--------------	------------------

224mm	\$29.00 ea
-------	-------------------



Orbit

Available in Matte White, Chrome, Matte Black

Projection 34mm

Hole centres	Individual Price
--------------	------------------

224mm	\$29.00 ea
-------	-------------------



Seashell

Available in Chrome, Brushed Nickel, Matte Black, Brushed Brass

Projection 23mm

Individual Price: \$19.00 ea



Classic Knob

Available in Chrome, Matte Black

Projection 30mm

Individual Price: \$19.00 ea



Premium Handles

To add a Premium Handle to your laundry, add \$20.00 per door/drawer.

To purchase individually see prices below.

Handles are position vertical on floor and tall cabinets, horizontal on drawer cabinets.

Blaze 60mm

Available in Brushed Nickel,
Matte Black, Matte White

Projection 21mm

Individual Price: \$39.00 ea



Blaze 350mm

Available in Brushed Nickel,
Matte Black, Matte White

Projection 21mm

Individual Price: \$59.00 ea



Francis

Available in Brushed Nickel, Matte
Black, Brushed Brass, Matte White

Projection 49mm

Hole Centres 170mm

Individual Price: \$59.00 ea



Aria

Available in Brushed Nickel, Matte
Black, Brushed Brass, Matte White

Projection 45mm

Hole Centres 170mm

Individual Price: \$59.00 ea



Fluted

Available in Brushed Nickel,
Matte Black, Brushed Brass

Projection 27mm

Hole Centres 128mm

Individual Price: \$59.00 ea



Bridge

Available in Brushed Nickel,
Matte Black, Brushed Brass

Projection 30mm

Hole Centres 160mm

Individual Price: \$59.00 ea



Stirling

Available in Matte White, Brushed Nickel,
Matte Black, Brushed Brass

Projection 28mm

Hole centres	Individual Price
128mm	\$39.00 ea
192mm	\$59.00 ea



Hammer

Available in Chrome, Brushed Nickel,
Matte Black, Brushed Brass

Projection 25mm

Hole Centres 32mm

Individual Price: \$59.00 ea



Fringe

Available in Brushed Nickel,
Matte Black, Brushed Brass

Projection 30mm

Hole Centres 160mm

Individual Price: \$59.00 ea



Reign

Available in Brushed Nickel

Projection 30mm

Hole Centres 160mm

Individual Price: \$59.00 ea



Reign Knob

Available in Brushed Nickel,
Matte Black, Brushed Brass

Projection 30mm

Individual Price: \$39.00 ea



Point Knob

Available in Brushed Nickel,
Matte Black, Brushed Brass

Projection 25mm

Hole Centres 16mm

Individual Price: \$39.00 ea



Cooper Knob

Available in Matte White, Brushed Nickel,
Matte Black, Brushed Brass

Projection 30mm

Diameter 38mm

Individual Price: \$39.00 ea



Loop Leather Pull

Available in Black or Tan

Length 70mm

Individual Price: \$59.00 ea



Pure Silk Cabinet Finishes

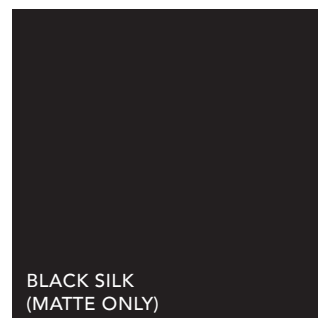
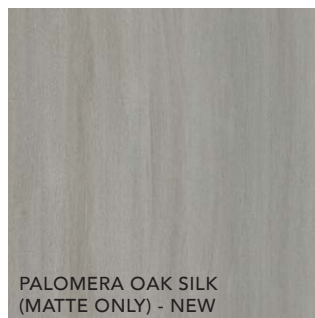
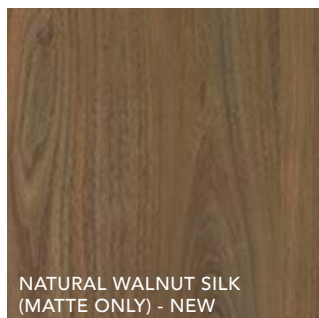
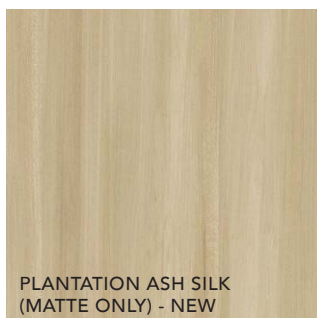
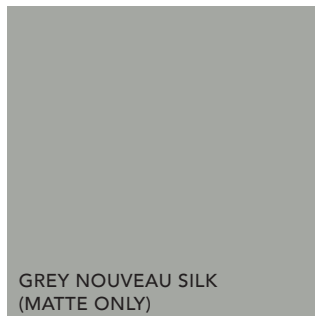
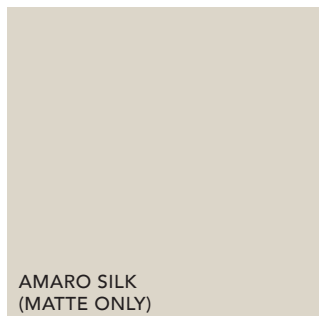

Decor or Classic Polyurethane Cabinet Finishes

Decor polyurethane fronts are plain, Classic polyurethane fronts are routed.

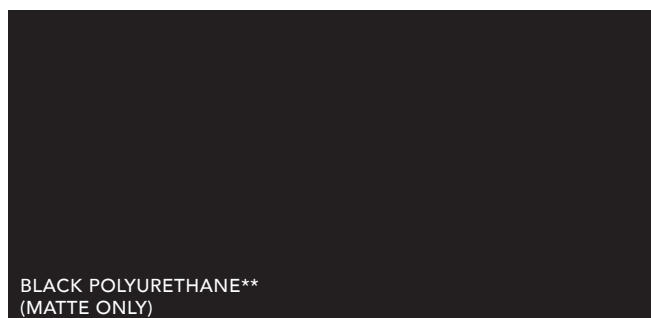
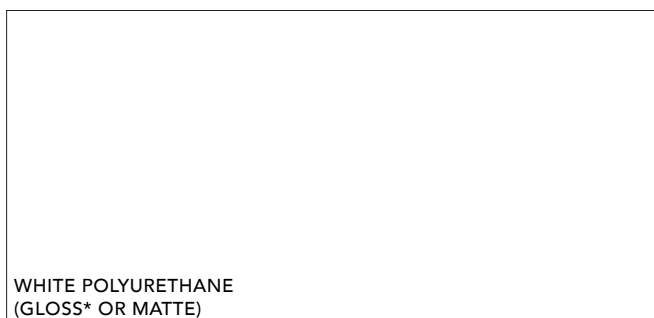

* Gloss White polyurethane not available on classic routed cabinets, matte only.

** Matte Black Polyurethane not available on Barn Door routed fronts.

No custom polyurethane colours available.

 All cabinets are made from Australian board sourced from sustainably managed forests.

Due to limitations in the printing process the colours in this brochure are a guide only. We recommend basing your selection on a physical colour sample, to see colour samples please visit a bathroom retailer. Go to www.adpastralia.com.au/stockists to find a stockist near you.

Decor Woodgrain Cabinet Finishes



WHITE PAINTED WOOD NATURAL (MATTE)



CONCRETE FORMWOOD CHALK
(TEXTURED)



FOX TEAKWOOD CHALK
(TEXTURED)



DELANA OAK CHALK
(TEXTURED)



ANGORA OAK WOODMATT
(TEXTURED)



RURAL OAK CHALK
(TEXTURED)



SEASONED OAK CHALK
(TEXTURED)



COASTAL OAK WOODMATT
(TEXTURED)

Decor Woodgrain Cabinet Finishes

NATURAL OAK RAVINE (TEXTURED)

ELEGANT OAK CHALK
(TEXTURED)

TASMANIAN OAK WOODMATT
(TEXTURED)

RAW BIRCH PLY
NATURAL (MATTE)

PRIME OAK WOODMATT
(TEXTURED)

BOSTON OAK WOODMATT
(TEXTURED)

FLORENTINE WALNUT WOODMATT
(TEXTURED)



NOTAIO WALNUT RAVINE (TEXTURED)



AGED WALNUT CHALK (TEXTURED)



ROJO WALNUT WOODMATT (TEXTURED)



BOTTEGA OAK WOODMATT (TEXTURED)

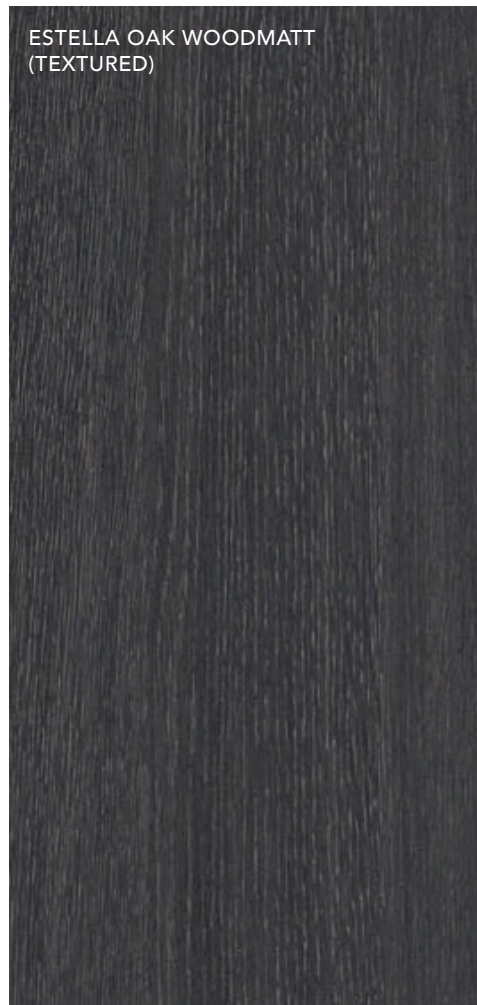

ESTELLA OAK WOODMATT (TEXTURED)

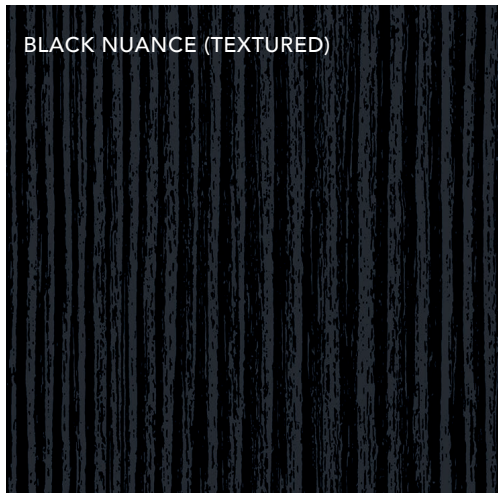

BLACK NUANCE (TEXTURED)



ANTICO OAK WOODMATT (TEXTURED)

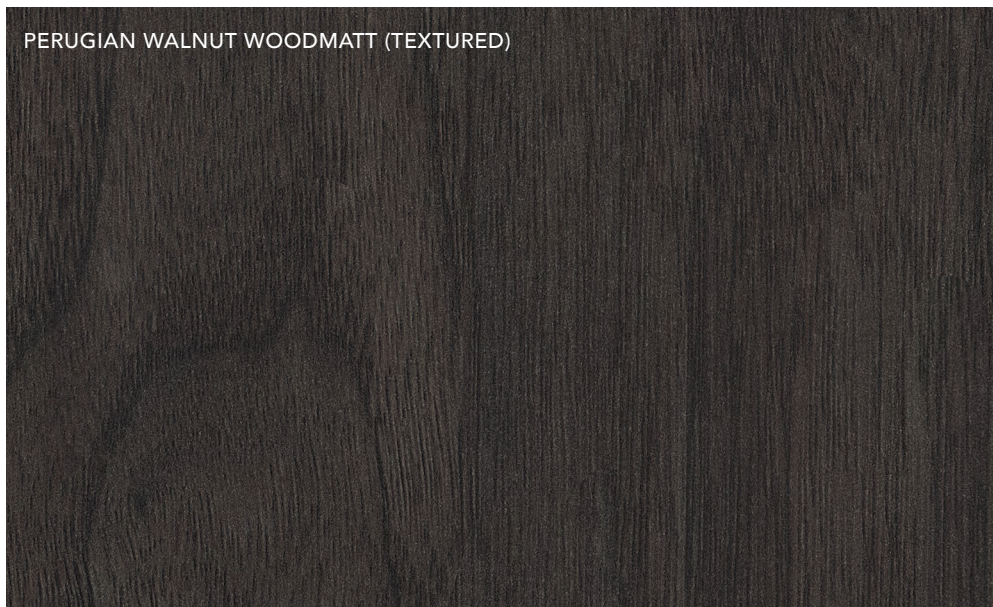

PERUGIAN WALNUT WOODMATT (TEXTURED)

Benchtop Finishes

Cherry Pie
Premium Solid Surface

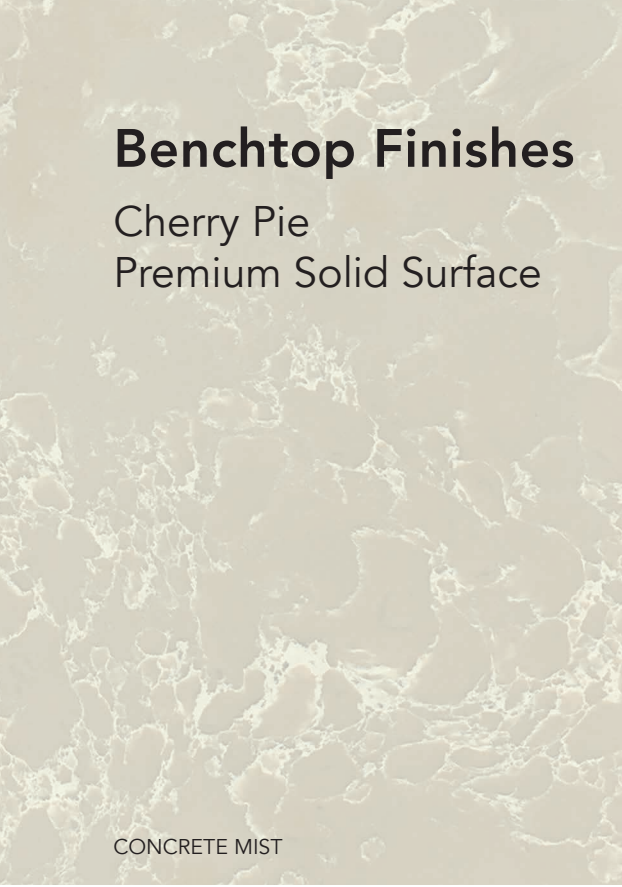
A close-up view of a solid surface finish with a complex, organic, and porous texture, resembling a mist or a natural stone pattern in shades of beige and cream.

CONCRETE MIST

A close-up view of a solid surface finish with a natural stone pattern, featuring light grey and off-white tones with subtle brown veining and a slightly textured surface.

GREY TRAVERTINE - NEW

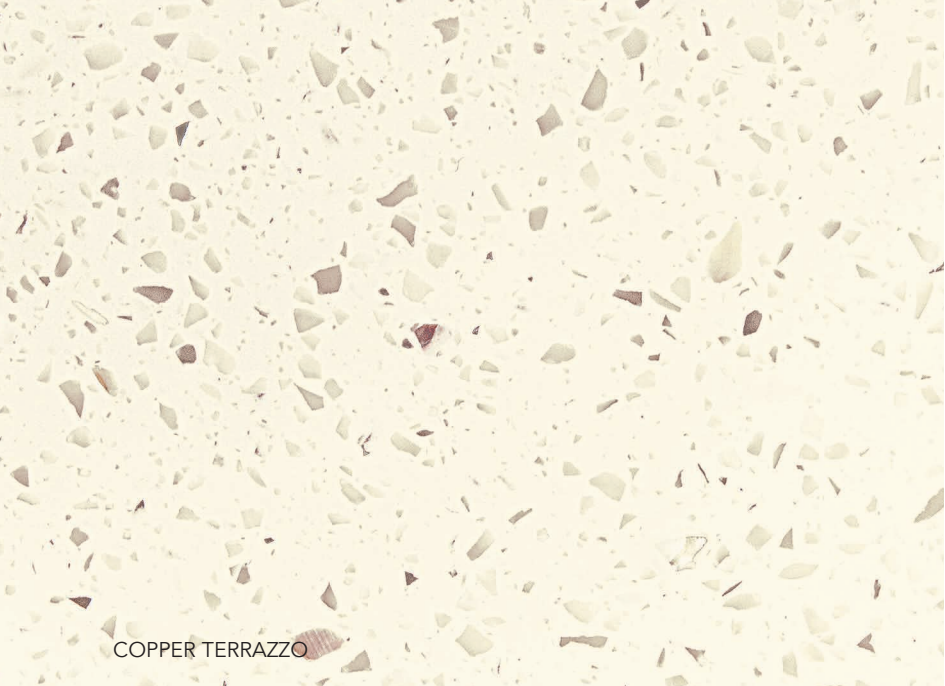
A close-up view of a terrazzo finish with a light cream background, featuring numerous small, irregular pieces of copper-colored aggregate.

COPPER TERRAZZO

A close-up view of a solid surface finish with a light, creamy, and slightly textured appearance, resembling natural alabaster stone.

ALABASTER - NEW

A close-up view of a solid surface finish with a light cream or off-white color and a fine, uniform texture, resembling sugar cream.

SUGAR CREAM

Due to limitations in the printing process the colours in this brochure are a guide only. We recommend basing your selection on a physical colour sample, to see colour samples please visit a bathroom retailer. Go to www.adpastralia.com.au/stockists to find a stockist near you.



CALACATTA



STACCATO



cherry pie

PREMIUM SOLID SURFACE

- Manufactured using acrylic resin solid surface material.
- Developed to withstand heat, chemicals, moisture, and impact.
- Resists stains better than natural stone surfaces.
- Cherry Pie is non-porous, hygienic, easy to clean, maintain, and repair.
- Does not require sealing or treating.

Variations in the finish are to be expected.

Cherry Pie is free of crystalline silica.

CARRERA



BRIGHT WHITE



AVALANCHE



WARRANTY

NOTE: Unless otherwise stated warranties for ADP products are as follows:

PRODUCT	DOMESTIC WARRANTY	COMMERCIAL WARRANTY
Cabinets	10 years	1 year
Cherry Pie Premium Solid Surface	10 years	1 year
Stainless Steel Sinks	15 years	1 year
Granite Composite Sinks	10 years	1 year
Hardware	7 years	1 year
Electrical / Lighting / Plumbing Fittings	1 year	1 year
Tapware		
Cartridge	15 years	1 year
Body (against manufacturing faults and flaking)	7 years	1 year
Parts and Labour	2 years	1 year
Bathroom Accessories	7 years	1 year

Our products come with guarantees that cannot be excluded under the Australian Consumer Law. You are entitled to a replacement or refund for a major failure upon inspection by an authorised representative where a product is found to be defective in construction, material or assembly. You are also entitled to have the goods repaired or replaced if the goods fail to be of acceptable quality and the failure does not amount to a major failure, free of charge.

CONDITIONS

1. Items must be installed by a licensed tradesperson.
2. Failure is due to a fault in the manufacture of the product.
3. Proof of purchase is provided.
4. The installation of the product is in accordance with the instructions provided.

EXCLUSIONS

To the fullest extent permitted by law, the manufacturer excludes all liability for damage or injury to any person, damage to any property and any indirect consequential or other loss or damage. Manufacturer will not be liable for the cost of installation or removal of any unit and the warranty will be VOIDED if damage occurred during or after INSTALLATION or a damaged or incorrect unit has been installed. Door and drawer adjustment; Unsuitable or improper use; Incorrect installation or installation not in accordance with the instructions provided; Installation or part installation by the purchaser or any person other than a LICENSED tradesperson; Normal wear and tear; Inadequate or complete lack of maintenance; chemical, electrochemical or electrical influences; excessive heat damage or Harsh detergents or abrasive cleaners used on product finishes, are NOT considered a warranty issue.

Solid Surface tops have a maximum water temperature of 65°C, water temperatures above this will void warranty.

CLAIM PROCEDURE

For all warranty queries customers are to contact the branch where the product was purchased. These details can be found on your purchase invoice.

INSTALLATION, CARE & MAINTENANCE

For installation, care & maintenance information visit www.adpastralia.com.au.



Eternal Sink Mixer, Brushed Nickel
Clovelly Round Sink

Modular Laundry Parts List



Pure Silk Laundry - Page 10

King Height Tall Cabinet - 900mm	PTDK90	\$889.00
Floor Cabinet with Hamper x 3	PFH45	\$659.00 ea
Floor Cabinet - 675mm	PFD67	\$439.00
500mm High Wall Cabinets - 675mm x 2	PWD567	\$419.00 ea
800mm High Wall Cabinets - 675mm x 3	PWD867	\$469.00 ea
Floor End Panel	FEP	\$149.00
Benchtop Support Rail - Double	WMR13	\$199.00
Benchtop - 3.375 m @ \$649 per lineal metre	CPTOP	\$2,190.38
Bellevue Small Rectangular Sink, Matte Black	SINKBEL4641BK	\$449.00
1.35m Hanging Rail, Matte Black @ \$39 per lineal metre	LDRYRAILBKLM	\$52.65
Cabinet Above End Flanges, Matte Black x 2	FITTWDEPSUPOB30	\$10.00 ea
Centre End Flange, Matte Black	FITTWDCPSUPOB30	\$15.00



Decor Laundry - Page 12

King Height Tall Cabinet - 450mm	DTDK45	\$939.00
Floor Cabinet - 850mm (priced as 900mm)	DFD90	\$599.00
Open Shelf - 850mm (priced as 900mm)	DWS390	\$389.00
500mm H Wall Cabinet - 850mm (priced as 900mm)	DWD590	\$489.00
800mm H Wall Cabinet - 675mm x 2	DWD867	\$519.00 ea
Floor End Panel	FEP	\$149.00
Benchtop Support Rail - Double	WMR13	\$199.00
Benchtop - 2.2m @ \$649 per lineal metre	CPTOP	\$1,836.80
40mm Mitred Benchtop Upgrade		\$409.00
Bellevue Small Rectangular Sink, Matte Black	SINKBEL4641BK	\$449.00
Soul Pull Out Kitchen & Laundry Mixer, Matte Black	JTAPKPSOUBA	\$349.00



Classic Laundry - Page 14

King Height Tall Cabinet with Broom Split - 900mm	CTBK90	\$1,419.00
Benchtop Support Rail - Single	WMR67	\$99.00
Drawer Cabinet - 675mm	CFA67	\$869.00
Floor Cabinet - 675mm	CFD67	\$679.00
Tan Leather Pull - Premium Handles x 7		\$20.00 ea
800mm H Wall Cabinet - 675mm x 3	CWD867	\$599.00 ea
Benchtop - 2.03m @ \$649 per lineal metre	CPTOP	\$1,317.50
Bellevue Round Sink, Matte White	SINKBEL435WHT	\$419.00
Eternal Pull Out Kitchen & Laundry Mixer, Brushed Copper	JTAPKPSOEBCO	\$379.00



Mix Your Styles Laundry - Page 16

Decor Standard Height Tall Cabinet with Open Shelves - 450mm	DTSS45	\$889.00
Benchtop Support Rail - Single	WMR67	\$99.00
Decor Floor Cabinet with Hamper	DFH45	\$729.00
Decor Floor Cabinet - 900mm	DFD90	\$599.00
Matte White Francis - Premium Handles x 3		\$20.00 ea
Classic 500mm H Wall Cabinets - 675mm x 3	CWD567	\$539.00 ea
Benchtop - 2.03m @ \$649 per lineal metre	CPTOP	\$1,317.50
Bellevue Large Rectangular Sink, Matte White	SINKBEL7945WHT	\$629.00
Soul Pull Out Kitchen & Laundry Mixer, Brushed Brass	JTAPKPSOUBB	\$349.00
Soul Single Towel Rail, 600mm, Brushed Brass	JACCSOUST6BB	\$189.00
Soul Robe Hook, Brushed Brass	JACCSOURHBB	\$109.00

Get the look | Vibrant Coastal



Coastal Oak Woodmatt
Floor Cabinets
Bevel-grip finger pull



Matte White Polyurethane
Wall Cabinets



Bellevue Round Sink
Matte White



Bloom Sink Mixer
Brushed Brass



Feature splashback tiles are perfect to add depth, texture and personality within the space

Open Shelves are a great place to add styling elements and bring life to the laundry

Mix & Match cabinet finishes to create contrast and balance to the design



Get the look | Tuscan Beachside



Coastal Oak Woodmatt
Floor Cabinets
Bevel-grip finger pull

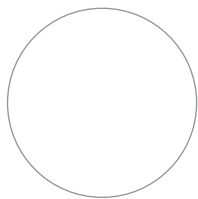

60mm Mitred Bright White
Cherry Pie Benchtop



Bellevue Round Sink
Matte White



Electric Clothes Hanger

Get the look | Contemporary Retro

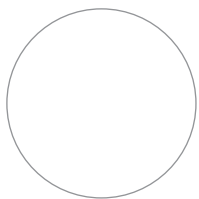

Matte White Polyurethane
Floor Cabinets
Bevel-grip finger pull



Prime Oak Woodmatt
Wall Cabinets



Clovelly Small Rectangular
Stainless Steel Sink



Soul Sink Mixer
Brushed Nickel



Brushed Nickel finish is a timeless choice and pairs well with most styles

Choose bevel-grip finger pull for a sleek and modern look, plus easy cleaning!

Laundry designed by Hemma Interiors



Transform the space into a multi-functional area with elements from the bathroom

Create interest with routed cabinet fronts when using a simple colour palette

Get the look | Modern Farmhouse



Classic Barn Door Cabinet Fronts, Matte White Point Knobs, Brushed Nickel



60mm Mitred Carrera Cherry Pie Benchtop



Clovelly Round Sink Stainless Steel



Eternal Sink Mixer and Towel Ring, Brushed Nickel

CABINETS
BENCHTOPS
SINKS
TAPWARE
ACCESSORIES
+ MORE



Where to buy

Due to limitations in the printing process the colours in this brochure are a guide only. The manufacturer/distributor reserves the right to vary specifications or delete models from their range without prior notification. All measurements within this brochure are nominal and are subject to change. The manufacturer/distributor take no responsibility for printing errors. Specifications correct at time of printing 06/2023. Please visit www.adpaustralia.com.au for most current technical information.

A Architectural
Designer
Products

adpaustralia.com.au



@adpaustralia