



Thermogroup



That little bit extra...

PRODUCT GUIDE

2023

Our Values

Trust

We operate on the basis of trust. Speed happens when people trust each other, allowing us to serve our customers in the best possible way.

Put Customers First

We put customers at the centre of everything we do to ensure we achieve the very best outcome for the customer. We are committed to going above and beyond to deliver that little bit extra.

Passionate

Through a love of what we do, we delight our clients. We are serious about results and are driven by our sense of urgency to achieve. We are focused on our goals and wholeheartedly committed to always giving 100%.

Strive for Simplicity

We believe that there is always a simpler way of doing everything and we are committed to finding the simplest option in every scenario.

Continuous Improvement

We do not fear change; instead, we encourage innovation, creativity and being on the leading edge. There is always further to go and more to explore through challenging the status quo.

Positive

Positivity is a choice to be optimistic, content, and upbeat. We aim to create an environment where positivity can thrive, so people can laugh, have fun and do good.

Contact Us

Phone 1300 368 631
Technical Line 1300 989 464
Fax 1300 655 532

Head Office
19 Ridley Avenue
Leeton NSW 2705

Warehouse Locations
Leeton NSW
Sydney NSW
Perth WA
Hobart TAS

Email
sales@thermogroup.com.au
marketing@thermogroup.com.au

Mail
PO Box 822
Leeton NSW 2705

www.thermogroup.com.au

Thermogroup

 That little bit extra...



Contents



Underfloor Heating 08

The benefits of Underfloor Heating	09
How does Underfloor Heating compare to traditional heating?	10
Helping you to understand Underfloor Heating	11
Which Underfloor Heating system is best for your project?	16
Thermonet Underfloor Heating System	18
Thermowire & Thermoscreed Underfloor Heating System	30
Thermofoil Underfloor Heating System	42
Thermoslab Underfloor Heating System	46
Underfloor Heating FAQs	48



Controls & Accessories 50

The benefits of heating controls	51
Thermotouch 7.6iG Glass Programmable Thermostat	52
Thermotouch 4.3dC Dual Programmable Thermostat	54
Thermotouch Wi-Fi Programmable Thermostat	56
Thermotouch Manual Thermostats	58
Accessories	60
Thermostat FAQ's	61



Insulation 62

The benefits of Econoboard Insulation	63
Econoboard Coated Insulation	64
Econoboard Uncoated Insulation	66



Space Heating 68

TF1800 Fan Heater	69
TF2400 Fan Heater	70
Heated Carpet Mat	71



Heated Towel Rails 72

Why choose a Heated Towel Rail	73
Types of Heated Towel Rails	74
Thermorad	76
12V Single Bar Range	81
12V Vertical Bar Range	86
12V Ladder Range	92
240V Vertical Bar Range	95
240V Ladder Range	96
240V Swivel Range	110
240V Floor to Ceiling Rail	112
240V Free Standing Range	113
240V Heritage Rail	114
Thermorail Custom Plated Colour Finishes	115
Non-Heated Range	118
Multiflex Wiring Explained	120
Positioning your Thermorail	121
Heated Towel Rail FAQ's	122



Mirrors 124

Premium Backlit Mirrors	126
Lit Magnifying Mirrors	130
Non-lit Magnifying Mirrors	132
Black Frame Mirrors	134
Frameless Mirrors	136
Thermomirror Demister Pads	146
Mirror Cabinet	148
Ablaze Mirror FAQ's	149



Warranty Information 150

Warranty and Guarantee Information	150
Underfloor Heating	152
Thermostats	152
Space Heating	152
Heated Towel Rails	153
Ablaze Mirrors	154



Creating a sustainable electric future

Homeowners, governments and the energy sector are looking for ways to reduce the use of fossil fuels and utilise clean affordable energy sources. The Australian government has committed to becoming carbon neutral by 2050.

Electricity is one of the best choices for a clean future-proof heating system as opposed to traditional forms of heating. Electricity is increasingly being generated by renewable sources on both a domestic and commercial scale.

Electric Underfloor Heating systems reflect the benefits of electric heating in the following ways.



100% efficient at the point of use. Every unit of electricity that you pay for becomes heat energy.



All of our heating products can be run using a solar electric system.



Thermostats allow for a higher level of monitoring and control than other forms of heating.



Zero ongoing maintenance and very low lifetime cost when compared to a gas or aircon heating systems.



Much lower safety risk than a gas system as there is no fossil fuel consumption and no potential for gas leaks or carbon monoxide issues.



Insulation helps to reduce heat loss, improve the efficiency of the system and reduce running costs.



Image Source: Jean Stoffer Design

Underfloor Heating

Contents

How does Underfloor Heating compare to traditional heating?	10
Helping you to understand Underfloor Heating	11
Which Underfloor Heating system is best for your project?	16
Thermonet Underfloor Heating System	18
Thermowire & Thermoscreed Underfloor Heating System	30
Thermofoil Underfloor Heating System	42
Thermoslab Underfloor Heating System	46
Underfloor Heating FAQs	48

The benefits of Underfloor Heating



Comfortable heat

Underfloor Heating spreads heat evenly across the floor allowing it to naturally and gently heat the room.



Energy efficient

Hot air rises naturally making heating at ground level an efficient way to heat the room.



Accurate control

With the use of a thermostat you can control when your floor heating is on and off and control the temperature.



Allergy friendly

There is no air or dust movement, making it the perfect system for allergy or asthma sufferers.



Warm floors

Eliminate cold floors and experience warmth and comfort from your toes up.



Zero maintenance

Our systems are electric, meaning they are maintenance and hassle free.



Lifetime warranty

Every system is tested in our manufacturing plant in Germany and we can offer you peace of mind with our lifetime cable warranty.



Rapid heat up time

With Underfloor Heating installed directly below your tiles you have an on-demand heating system.



Interior design freedom

With the heating system invisible below your floor you can design your room how you please without any heaters to work around.

How does Underfloor Heating compare to traditional heating?

An Electric Underfloor Heating system provides an energy efficient, on demand heating system as well as interior design flexibility which improves the comfort and space for everyone.

Radiators and Air Conditioning



Inefficient convection heating

Traditional convection heaters distribute heat unevenly throughout a room, resulting in drafts, hot heads and cold feet.

Heating in this way usually means your thermostat must be set to a higher temperature to achieve the desired comfort level, which increases heat loss and energy bills.

As the heat moves away from the single heat source in the room it cools making it uneven and uncomfortable.

Underfloor Heating

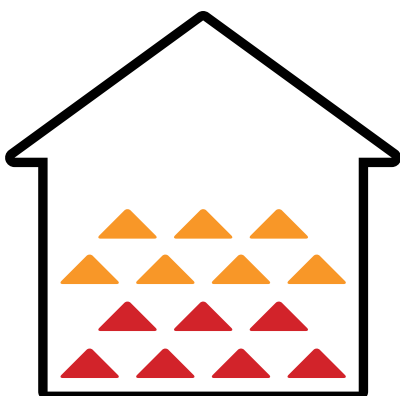

Improved efficiency and comfort

Electric Underfloor Heating is a system by which a series of electric heating cables are run below the floor finish. The entire floor then becomes a heater with the heat gently radiating up from the floor into the room. Hot air naturally rises, therefore heating from the floor is the most efficient and effective form of heating and it gently, evenly and silently warms any room creating a comfortable and enjoyable environment.

Where the heating covers more than 80% of the room it can be used as the primary heat source. You can also free up valuable wall space creating freedom for interior design.

Helping you to understand Underfloor Heating

Underfloor Heating provides the most comfortable form of affordable and efficient heating that you could desire for your home. We have put together some key content to help you better understand Underfloor Heating.

The Golden Rule of Underfloor Heating



Never Cut the Cable

An Underfloor Heating cable cannot be cut or shortened. As it is a resistive cable, no Underfloor Heating cable can be cut or shortened even if its done by an electrician. Underfloor Heating should not be installed under floor mounted fixtures (i.e. toilet or cabinetry) so make sure you select the right size kit for the room.

How much Underfloor Heating do I need?



Overall Room Size

Work out the overall floor area of the room.



Subtract Fixtures

Minus all the floor mounted fixtures from the overall floor area to give you the square meters of the available floor area.



Select Size

Match the available floor area with the correct size system for your floor build up.

Free Quoting Service

Thermogroup offers an obligation free quoting service. Simply send us your plan showing your room size and fixtures, specify the floor finish and we will provide a quotation for your specific requirements.

Simply email your plan to sales@thermogroup.com.au or use our online quoting tool.

Helping you to understand Underfloor Heating

Who installs the Underfloor Heating

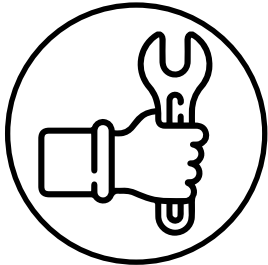

Every Underfloor Heating System comes as a complete product, you don't need to make any electrical connections whilst laying the system. This means the Underfloor Heating can be installed by anyone, the electrician, tiler, builder, or even the home owner*.

Typically, the electrician will install the floor heating as they will need to do the pre-wiring, testing and fit off the Thermostat regardless of who lays the heating.

**This may vary for your state so check local guidelines.*

Will Underfloor Heating heat my room?



Yes, as long as 80% of the floor is covered with Underfloor Heating it can be used as the primary heat source to heat your entire room. Insulation below the Underfloor Heating will further help to improve the heat performance in the room.

The Power of Insulation



Whilst insulation won't increase the temperature of the heating in your room, installing a layer of insulation below your Underfloor Heating will help to reduce heat loss.

This improves the heat-up times and reduces the running costs to improve the overall efficiency by up to 50%.

Refer to pages 62-67 for further information.

Underfloor Heating Costs

How much does Underfloor Heating cost to run?

\$0.05

Based on an insulated floor with a 150W/m² Underfloor Heating system and an electricity tariff of 34c/kWh, the cost to run the Underfloor Heating will be \$0.05 per hour. This is based on the system being actively running for the full hour, once the floor reaches the set temperature it will operate only to maintain the temperature level. The system will then heat for about 40% of the time to maintain the temperature.

The best way to control your running costs is with your thermostat by setting up a heating schedule so the heating is only on when you need it. The thermostat will also allow you to set a comfort temperature of around 22-24 degrees.

How much electricity does Underfloor Heating use?

Our homes are full of electrical goods, some of which have a much higher energy consumption than you may think. Ultimately the amount of electricity used will depend on your system however below are some examples of the average wattage of some familiar products found in homes all over Australia.

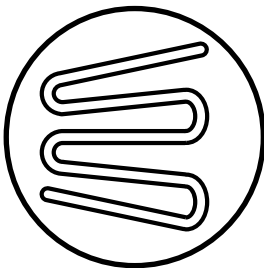

3m² Floor Heating System
600W** - \$0.82*

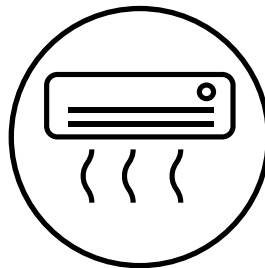

High Wall Air Conditioner
2500W - \$3.40*

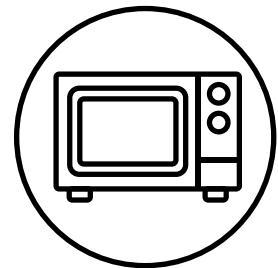

Microwave Oven
1000W - \$1.36*

*Daily running cost based on running 4 hours a day

**Based on 200W per square metre

How much does an Underfloor Heating system cost?

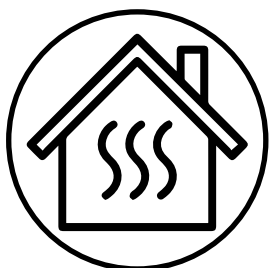

Whilst this will vary based on your requirements, the most common bathroom size is 3.5m². This is the size of the heatable area once all fixtures have been removed.

Based on this, a 200W Thermonet Kit including the mat and controller would cost **\$847.00** to purchase.

Underfloor Heating Heat up times

The floor construction and finish will govern heat up times. Sufficient insulation such as Econoboard, will greatly reduce heat up times and you will notice the difference in your energy bills. A well insulated Thermonet system can be up to 50% more efficient than an un-insulated system, especially when managed by a programmable thermostat. Average heat up times can be seen in the table below:

System	150W/m ²	200W/m ²
Un-insulated Concrete	2 - 4 hours	1 - 3 hours
Concrete with 10mm Econoboard	45 mins	30 mins
Concrete with 10mm Econoboard & 25mm Screed	2 hours	90 mins
Un-insulated Timber Substrate	1 hour	45 mins
Timber Substrate with 10mm Econoboard	45 mins	30 mins

(Allow an additional 1 hour per 25mm of screed for heat to penetrate)

PLEASE NOTE: The information provided on pages 10-14 is gathered from multiple online sources and provided as an illustrative example only. This information does not imply any warranty or guarantee of energy consumption and/or electricity costs. E&OE.

Use our online tools and learning hub to:



- ✓ Select your correct system
- ✓ Estimate your running cost
- ✓ Get an instant quote
- ✓ Learn more about Underfloor Heating



Underfloor Heating in your shower

Thermogroup Underfloor Heating systems are designed to be safely installed in a tiled shower which brings some distinct benefits to your bathroom.

Eliminate the build-up of mould and grout discolouring

By installing Underfloor Heating beneath your shower floor, and even running it up the wall, the drying time of your shower area will be dramatically reduced. This will help to eliminate the likelihood of mould build-up and discolouring of grout which is caused by moisture.

Reduce the slip hazard

Another advantage of drying the shower floor, and indeed the whole bathroom floor, with Underfloor Heating, is that it helps to reduce the slip hazard. This is particularly where you have an open shower with the potential for water over spray onto the bathroom floor.

Fully waterproof

Our Underfloor Heating systems are IP67/8 rated which makes them perfectly safe to install in your shower area as the systems are fully waterproof.

One system for the shower and floor

As all our systems are safe to run in the shower, you can simply run the same mat across your bathroom and into the shower making install and ongoing control of your floor heating simple and easy. It is recommended not to start or finish the heating in the shower.



Can I run Underfloor Heating up the wall behind my towel rail to dry my towels?

Yes, this can be done however as a simpler alternative we recommend you check out our Thermorad solution on pages 76-79.

Which Underfloor Heating system is best for your project?

Undertile Heating



Tiles are a very popular and common floor finish; however one major disadvantage is they are cold to walk on, especially in winter. This can be overcome with an undertile heating system which allows you to experience the feeling of a warm tiled floor.



Thermonet 150W/m²

Thermonet 150W/m² is an Underfloor Heating mat system that is specially designed to be installed directly beneath your tiles in large areas. See more details on pages 18-29.



Thermowire 13W/Lm

Thermowire is the traditional loose wire heating system that features a robust cable that is designed to last a lifetime. Thermowire is designed to be installed directly below the tiles in small awkward areas. See more details on pages 30-41.

In screed and Under Stone Heating



In screed heating systems are very versatile in their application as they are suitable for use with almost any floor covering. Putting a screed over your heating system before tiling also ensures that there is minimal risk of damage while tiling and a flat surface to tile onto.



Thermonet 200W/m²

Thermonet 200W/m² is an Underfloor Heating system that is designed to be installed in the screed layer and allows for quick and easy installation. See more details on pages 18-29.



Thermoscreed 18W/Lm

Thermoscreed is a heavy duty 5.5mm thick cable, designed to be installed in the screed layer for small awkward areas. See more details on pages 30-41.

Under Timber, Carpet and Laminate Heating



Laminate and engineered timber floors are becoming more and more popular due to their eco-credentials, and the natural look and feel of a wooden floor. Thermofoil brings the ease and simplicity of Electric Underfloor Heating to timber floors. Although carpet is not a cold floor finish, Thermofoil can also be used under carpet to keep your home warm. For under carpet installations, Thermofoil should be installed between the underlay and the carpet.



Thermofoil

Thermofoil is specially designed to operate in a void i.e. between carpet or timber flooring and the underlay making installation extremely quick and easy. See more details on pages 42-45.

In Slab Heating



Unlike undertile heating, in slab heating is designed to heat the entire slab, which then creates an energy efficient thermal mass under your floor.



Thermoslab 30W/Lm

Thermoslab is a versatile, robust 7mm thick heating cable that is designed to be attached to the concrete mesh prior to the concrete being poured. See more details on pages 46-47.

Insulation



Insulation below your Underfloor Heating reduces heat up times and running costs.

See more details on pages 63-67.



Heating System Selector Tool

Use our online Heating System Selector tool to determine the best Underfloor Heating system and accessories based on your application.

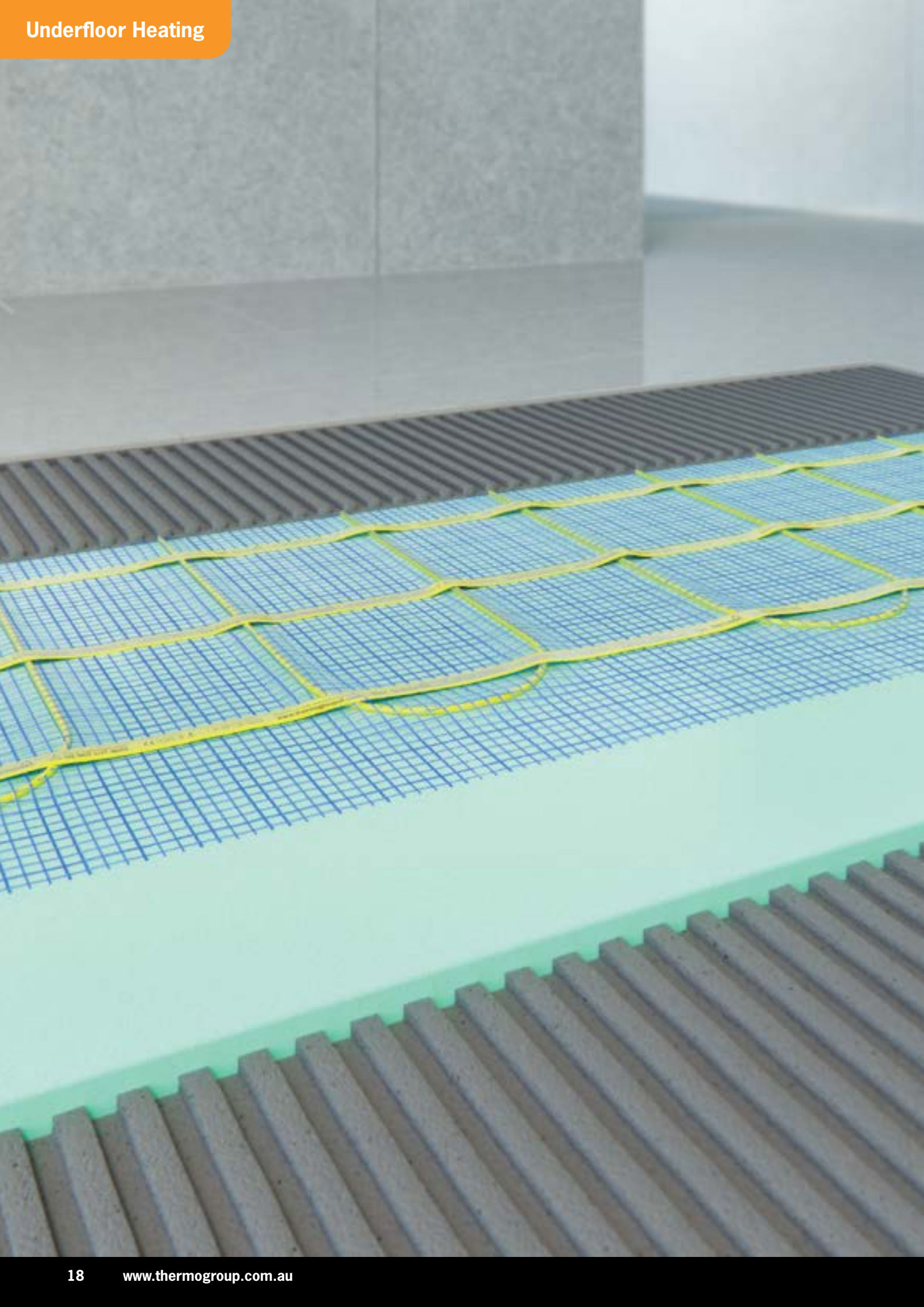

Thermonet Underfloor Heating Systems

Thermonet is a versatile Electric Underfloor Heating mat system designed for easy installation under a range of floor finishes.

There are two different Thermonet systems, offering an option for undertile and in screed, each offering the benefits of our market-leading matting system.



Lifetime warranty

We are so confident in the quality of our German-made Thermonet Underfloor Heating that we give each system a warranty that lasts a Lifetime with a 3 year warranty on our Thermostats.



Twisted Twin cable construction

Our cables have a unique construction where the two heating cores are twisted together inside the cable making it extremely durable, reducing stress on the cable and eliminating any electromagnetic field. The Zero EMF credentials are unique and gives you peace of mind that your Underfloor Heating will have no negative effect on your body.



Fully self adhesive mesh

The self adhesive mesh speeds up installation by holding the Thermonet matting to the substrate for easy self levelling and tile fixing. It also ensures an even and consistent cable spacing across the floor to ensure an even heat.



Heating cable protection

Thermonet is installed wire-side-down which means the heating cable is protected from damage during installation by the hard wearing mesh layer.



Minimal height build-up

Utilising innovative extrusion processes provides real 'lay flat' technology that makes installing Thermonet easy. The matting system is only 3.5mm thick with a low profile cold tail of only 4mm thick which is typically concealed within the tile adhesive layer.

Thermonet installation overview

This diagram displays a typical bathroom layout with Thermonet Underfloor Heating. The mat system ensures a fast and simple installation with the heating mat covering the entire available floor space. Some of the key features of the Thermonet Underfloor Heating systems have been highlighted below.

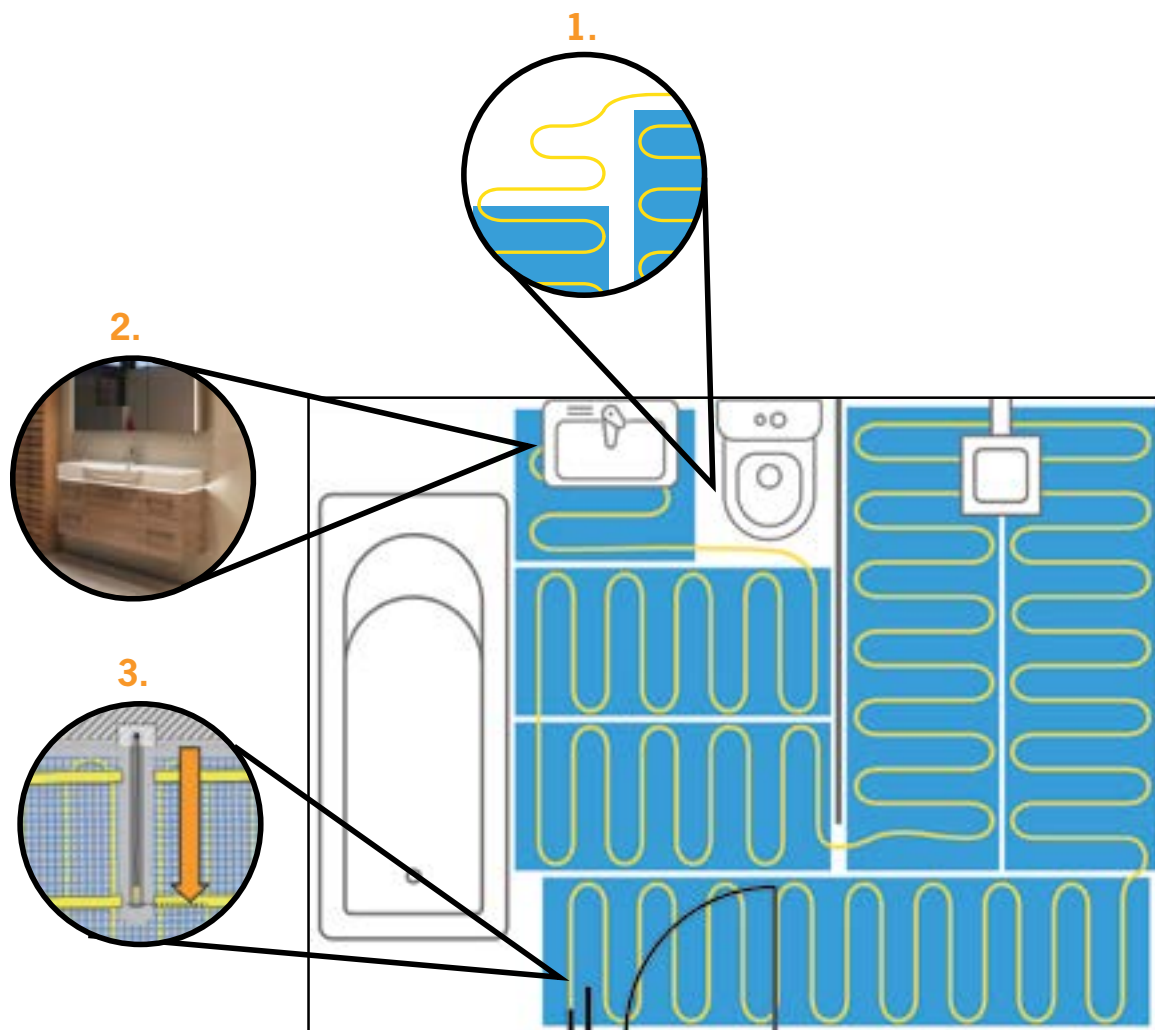

1. Modify the mat

When Thermonet mats are needed to fit around irregular shapes like a toilet or vanity, simply remove the cable from the mesh and arrange in loops to cover the area.

2. Wall mounted fixtures

If you have a wall hung vanity always allow enough floor heating to run under the front of the vanity to ensure this floor area is warm.

3. Floor sensor and conduit

Ensure the floor sensor is installed in the conduit and placed equally centred between two runs of heating cable to provide an accurate floor temperature reading.

Cut-and-return installation explained

Every room is different, and you will usually need to modify your Thermonet mat in some way to fully cover your desired heating area. The diagrams on this page will help you to manipulate your Thermonet mat safely and avoid causing any damage during installation.

Cutting the mesh

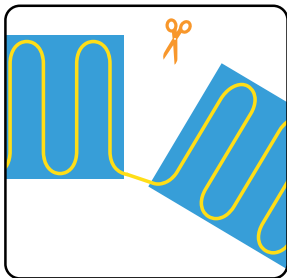

Use scissors to carefully cut the blue mesh

Turn 180°

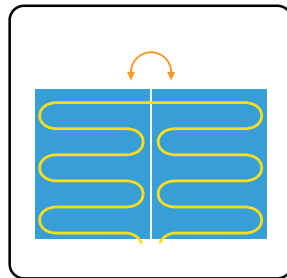

Turn the mat 180° laying parallel to the first run

Turn 90°

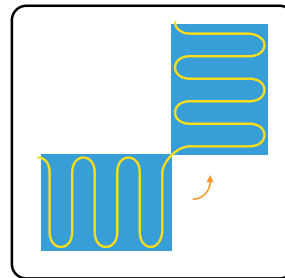

Turn the mat 90° for a more simple turn

Alternative 90°

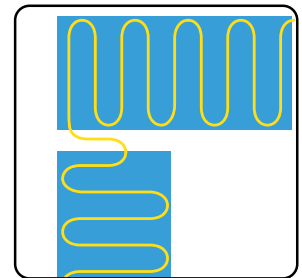

Release cable from the mat for an alternative 90° turn



NEVER CUT THE HEATING CABLE! When performing any of these mat modifications it is vital that you do not cut or damage the heating cable. Damaging or shortening the cable will void your warranty and cause the cable to burn out or not work.

Thermonet floor build ups

Thermonet Electric Underfloor Heating can be used in almost any floor build-up or with any floor finish from tiles and vinyl to carpet and timber floors.

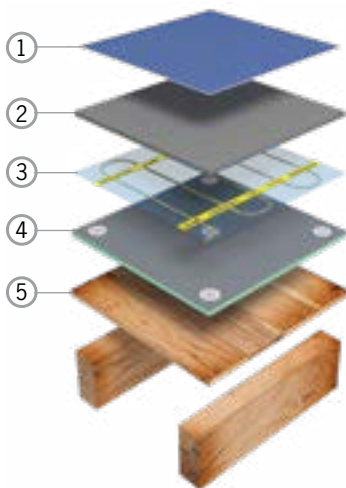

- ① Glued vinyl floor finish
- ② Flexible self levelling compound*
- ③ Thermonet heating mat
- ④ Econoboard coated insulation***
- ⑤ Prepared substrate

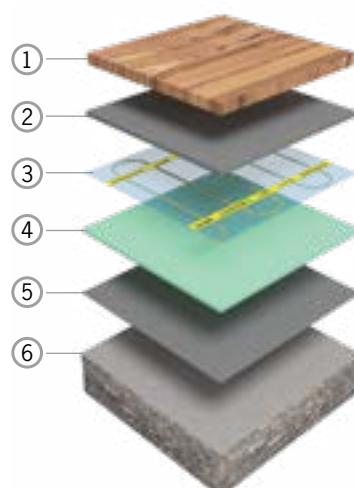

- ① Engineered timber floor finish
- ② Flexible self levelling compound*
- ③ Thermonet heating mat
- ④ Econoboard uncoated insulation***
- ⑤ Flexible tile adhesive
- ⑥ Prepared substrate

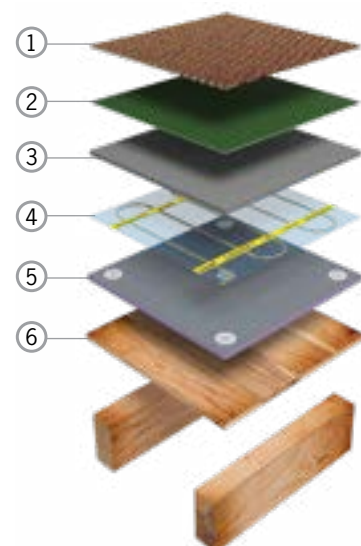

- ① Carpet floor finish**
- ② Low tog underlay**
- ③ Flexible self levelling compound*
- ④ Thermonet heating mat
- ⑤ Econoboard coated insulation***
- ⑥ Prepared substrate

*Minimum recommended thickness of 10mm. **Combined TOG rating needs to be under 2.5. ***Optional insulation layer

Thermonet 150W/m² Underfloor Heating Systems



Designed for use directly below the tiles, especially in larger areas.

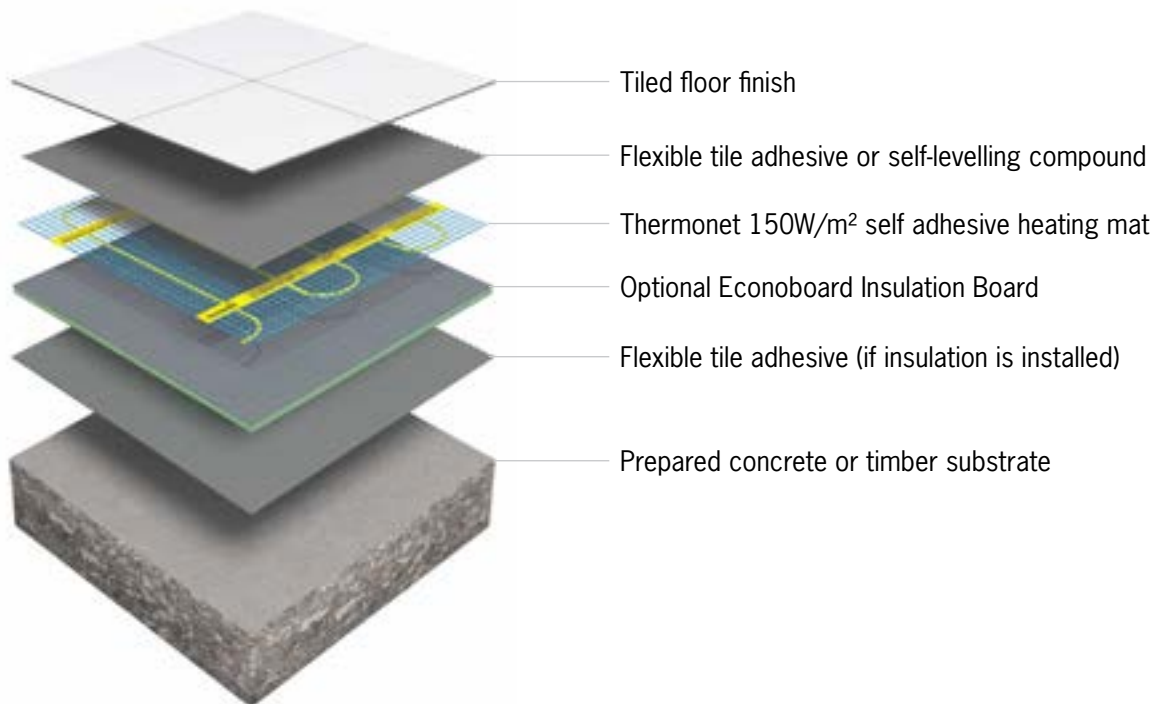

Rapid heat-up time

As the 150W system is installed directly below your tiles (up to 20mm thick) it provides rapid heat-up time through the tile layer. A layer of insulation below the heating will further help to improve the heat-up times and prevent downward heat loss.



Ideal for larger areas

The Thermonet 150W system is ideal for areas with a large floor surface. The mat provides an adequate heat source directly below the floor finish. The mat range includes mat sizes up to 16m², ideal for larger areas such as living rooms, kitchens and hallways.



Adaptable for multiple floor finishes

Whilst primarily designed for use directly below tiles, the 150W system can also be used for other floor finishes such as carpet, vinyl or glued floor finishes, provided it is covered with a 10mm layer of self-levelling compound and you have checked with the flooring manufacturer.

Thermonet 200W/m² Underfloor Heating Systems



Designed for use in bathrooms either directly below the tiles or below the screed.

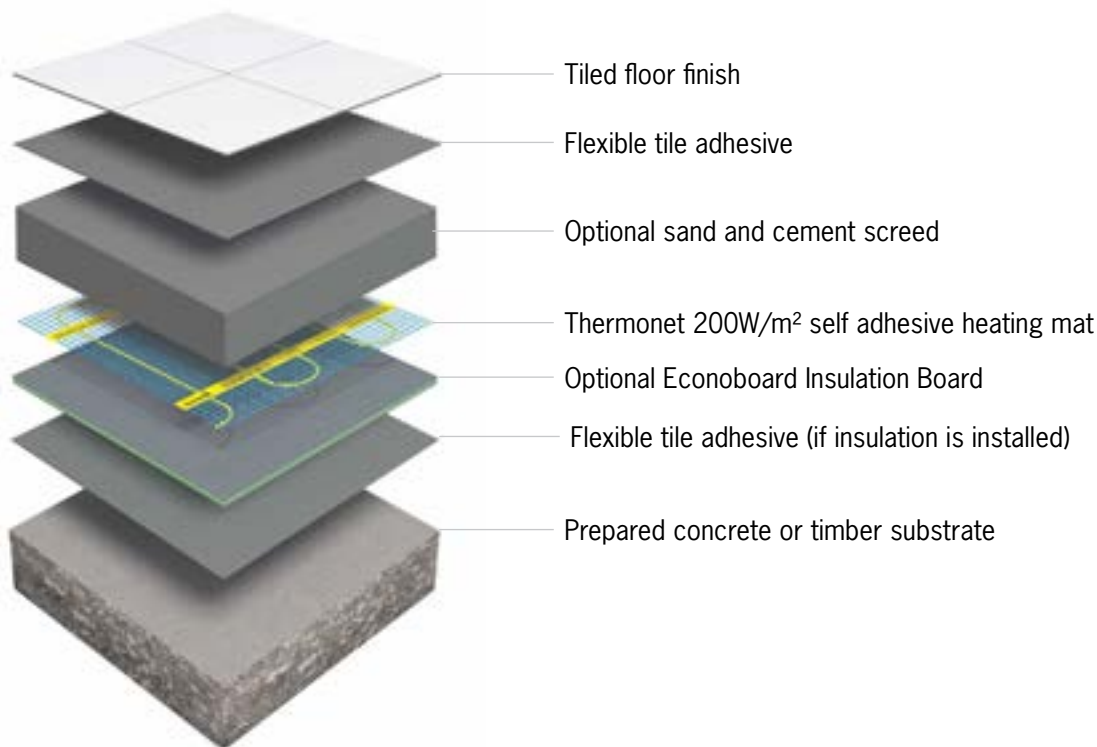

Ideal for rooms with limited floor space

The 200W/m² ensures the maximum heat output for the available floor area. This particularly applies in the case of a bathroom, where a lot of the heated floor area can be lost with floor mounted fixtures.



Perfect for high heat loss applications

The high heat output of the 200W mats makes them perfect for rooms that are prone to high heat loss. This can be further reduced by adding a layer of insulation below the heating.



Suitable for use in the screed

Suitable for installation in screeds of 20mm to 50mm to create a thermal mass. The 200W output ensures rapid heat-up time even through the screed. Installing a layer of insulation below the heating will further improve the heat performance.

What is a Screed?

A screed is a cement layer that is used to give a smooth level finish to a floor. Typically a screed is used in bathrooms to get the fall across the floor to the floor waste. When a screed layer is being installed, the Underfloor Heating is typically installed below the screed.

Thermonet Underfloor Heating Standard Thermostat Kits

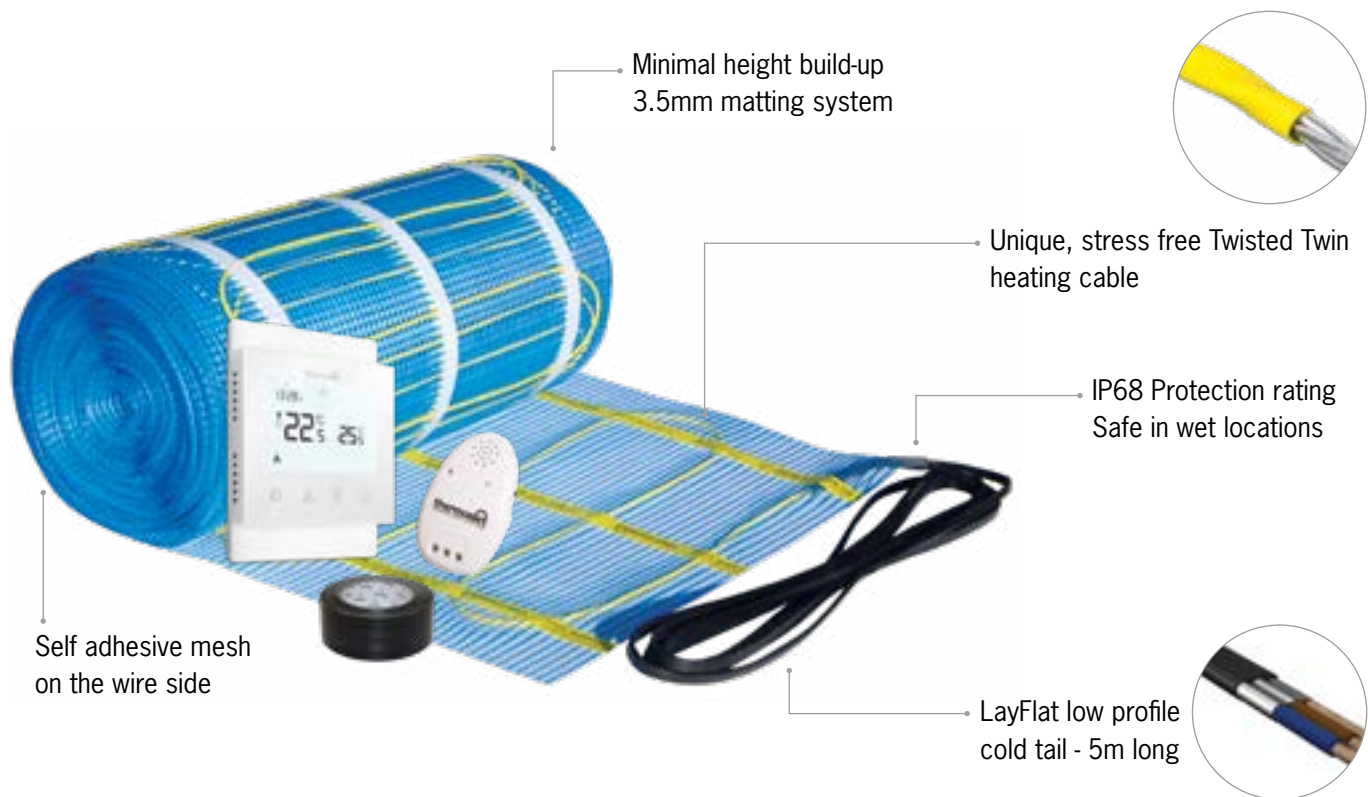

Standard Thermostat Kit Inclusions



Programmable Thermostat

Stock Code - 5220A

Fully programmable, 7-day thermostat, providing full control over your Underfloor Heating. More details on pages 52-53. Includes floor sensor and conduit.



Heating Cable Monitor

Stock Code - 6025

The cable monitor measures the cable integrity during installation and whilst the floor finish is being laid and will sound an alarm if damage occurs.



Roll of Cloth Tape

Stock Code - 3255

Cloth tape is used for securing loose runs of cable and holding down the corners of matting during installation.





150W Undertile Standard Control Kit

Stock Code	Size (m)	Area (m ²)	Output (W)	Amps (A)	RRP \$ Incl.
111502T	2 x 0.5	1.0	150	0.63	\$451.00
111503T	3 x 0.5	1.5	225	0.94	\$519.00
111504T	4 x 0.5	2.0	300	1.25	\$587.00
111505T	5 x 0.5	2.5	375	1.56	\$655.00
111506T	6 x 0.5	3.0	450	1.88	\$723.00
111507T	7 x 0.5	3.5	525	2.19	\$791.00
111508T	8 x 0.5	4.0	600	2.50	\$859.00
111509T	9 x 0.5	4.5	675	2.81	\$927.00
111510T	10 x 0.5	5.0	750	3.13	\$995.00
111512T	12 x 0.5	6.0	900	3.75	\$999.00
111514T	14 x 0.5	7.0	1050	4.38	\$1,113.00
111516T	16 x 0.5	8.0	1200	5.00	\$1,227.00
111518T	18 x 0.5	9.0	1350	5.63	\$1,341.00
111520T	20 x 0.5	10.0	1500	6.25	\$1,455.00
111524T	24 x 0.5	12.0	1800	7.50	\$1,683.00
111528T	28 x 0.5	14.0	2100	8.75	\$1,911.00
111532T	32 x 0.5	16.0	2400	10.00	\$2,139.00

200W In screed and Bathroom Standard Control Kit

Stock Code	Size (m)	Area (m ²)	Output (W)	Amps (A)	RRP \$ Incl.
112002T	2 x 0.5	1.0	200	0.83	\$467.00
112003T	3 x 0.5	1.5	300	1.25	\$543.00
112004T	4 x 0.5	2.0	400	1.67	\$619.00
112005T	5 x 0.5	2.5	500	2.08	\$695.00
112006T	6 x 0.5	3.0	600	2.50	\$771.00
112007T	7 x 0.5	3.5	700	2.92	\$847.00
112008T	8 x 0.5	4.0	800	3.33	\$923.00
112009T	9 x 0.5	4.5	900	3.75	\$999.00
112010T	10 x 0.5	5.0	1000	4.17	\$1,075.00
112012T	12 x 0.5	6.0	1200	5.00	\$1,095.00
112014T	14 x 0.5	7.0	1400	5.83	\$1,225.00
112016T	16 x 0.5	8.0	1600	6.67	\$1,355.00
112018T	18 x 0.5	9.0	1800	7.50	\$1,485.00
112020T	20 x 0.5	10.0	2000	8.33	\$1,615.00
112024T	24 x 0.5	12.0	2400	10.00	\$1,875.00

To purchase a kit with a black thermostat (5226A) add a 'B' after the stock code. The price remains the same.

Thermonet Underfloor Heating Dual Control Thermostat Kits



Dual Control Thermostat Kit Inclusions



Programmable Thermostat

Stock Code - 5245

Fully programmable dual thermostat, allowing you to control your Underfloor Heating and Heated Towel Rails on their own individual schedules. More details on pages 54-55. Includes floor sensor and conduit.



Heating Cable Monitor

Stock Code - 6025

The cable monitor measures the cable integrity during installation and whilst the floor finish is being laid and will sound an alarm if damage occurs.



Roll of Cloth Tape

Stock Code - 3255

Cloth tape is used for securing loose runs of cable and holding down the corners of matting during installation.





150W Undertile Dual Control Kit

Stock Code	Size (m)	Area (m ²)	Output (W)	Amps (A)	RRP \$ Incl.
111502TD	2 x 0.5	1.0	150	0.63	\$601.00
111503TD	3 x 0.5	1.5	225	0.94	\$669.00
111504TD	4 x 0.5	2.0	300	1.25	\$737.00
111505TD	5 x 0.5	2.5	375	1.56	\$805.00
111506TD	6 x 0.5	3.0	450	1.88	\$873.00
111507TD	7 x 0.5	3.5	525	2.19	\$941.00
111508TD	8 x 0.5	4.0	600	2.50	\$1,009.00
111509TD	9 x 0.5	4.5	675	2.81	\$1,077.00
111510TD	10 x 0.5	5.0	750	3.13	\$1,145.00
111512TD	12 x 0.5	6.0	900	3.75	\$1,149.00
111514TD	14 x 0.5	7.0	1050	4.38	\$1,263.00
111516TD	16 x 0.5	8.0	1200	5.00	\$1,377.00
111518TD	18 x 0.5	9.0	1350	5.63	\$1,491.00
111520TD	20 x 0.5	10.0	1500	6.25	\$1,605.00
111524TD	24 x 0.5	12.0	1800	7.50	\$1,833.00
111528TD	28 x 0.5	14.0	2100	8.75	\$2,061.00
111532TD	32 x 0.5	16.0	2400	10.00	\$2,289.00

200W In screed and Bathroom Dual Control Kit

Stock Code	Size (m)	Area (m ²)	Output (W)	Amps (A)	RRP \$ Incl.
112002TD	2 x 0.5	1.0	200	0.83	\$617.00
112003TD	3 x 0.5	1.5	300	1.25	\$693.00
112004TD	4 x 0.5	2.0	400	1.67	\$769.00
112005TD	5 x 0.5	2.5	500	2.08	\$845.00
112006TD	6 x 0.5	3.0	600	2.50	\$921.00
112007TD	7 x 0.5	3.5	700	2.92	\$997.00
112008TD	8 x 0.5	4.0	800	3.33	\$1,073.00
112009TD	9 x 0.5	4.5	900	3.75	\$1,149.00
112010TD	10 x 0.5	5.0	1000	4.17	\$1,225.00
112012TD	12 x 0.5	6.0	1200	5.00	\$1,245.00
112014TD	14 x 0.5	7.0	1400	5.83	\$1,375.00
112016TD	16 x 0.5	8.0	1600	6.67	\$1,505.00
112018TD	18 x 0.5	9.0	1800	7.50	\$1,635.00
112020TD	20 x 0.5	10.0	2000	8.33	\$1,765.00
112024TD	24 x 0.5	12.0	2400	10.00	\$2,025.00

To purchase a kit with a black thermostat (5246) add a 'B' after the stock code. The price remains the same.

Thermonet Underfloor Heating Mat Only

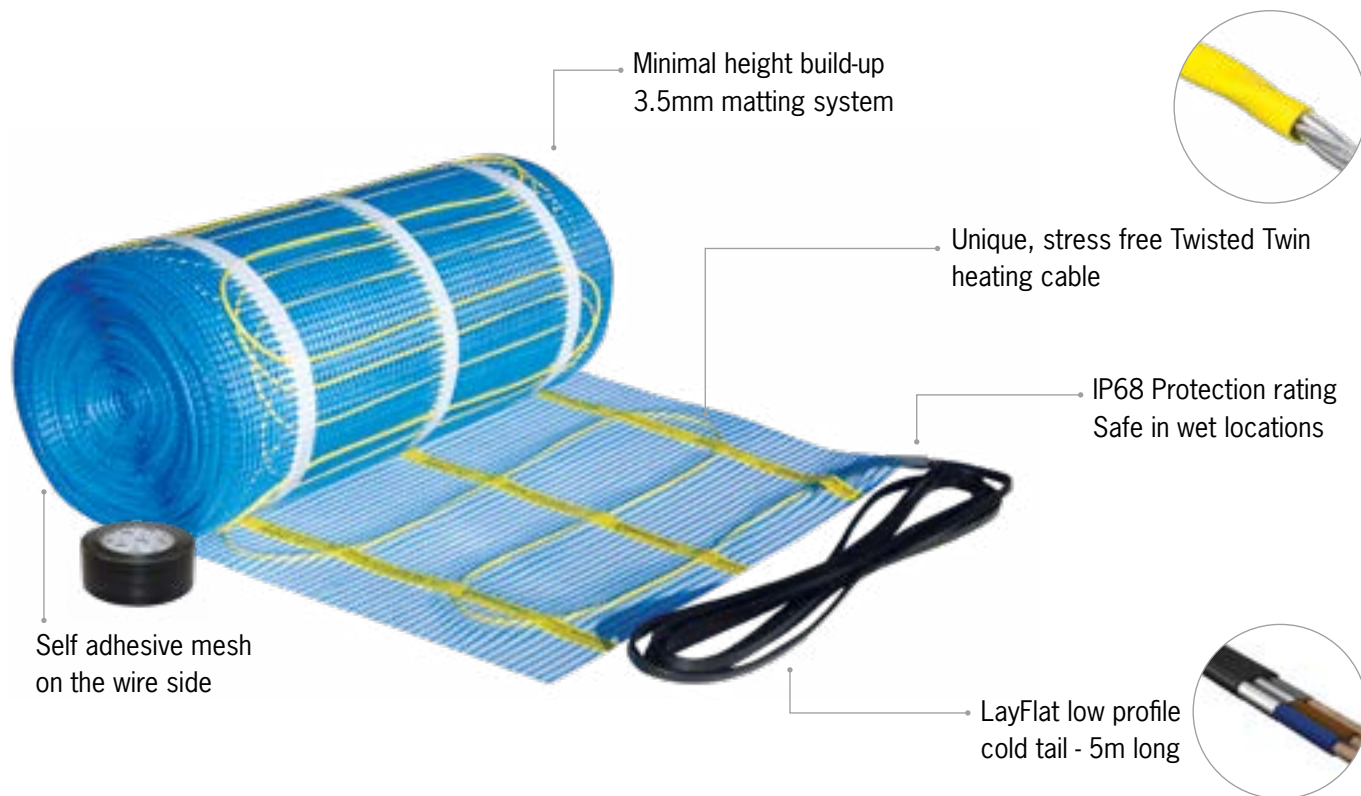

Includes:

- ✔ Thermonet Mat
- ✔ Cloth Tape
- ✔ Installation Guide with Warranty Form

Thermonet systems need to be wired to a thermostat. The mat only option is for use with a Wi-Fi or manual thermostat or when wiring multiple mats to one controller.

RRP
per m²

150W 1-5m² - 136/m²

Price includes Thermonet 150W/m² Mat only. Thermostats to be purchased separately for each zone. Price RRP inclusive.

6-16m² - \$114/m²

200W 1-5m² - \$152/m²

Price includes Thermonet 200W/m² Mat only. Thermostats to be purchased separately for each zone. Price RRP inclusive.

6-12m² - \$130/m²





150W Undertile Heating Mat Only

Stock Code	Size (m)	Area (m ²)	Output (W)	Amps (A)	RRP \$ Incl.
111502	2 x 0.5	1.0	150	0.63	\$136.00
111503	3 x 0.5	1.5	225	0.94	\$204.00
111504	4 x 0.5	2.0	300	1.25	\$272.00
111505	5 x 0.5	2.5	375	1.56	\$340.00
111506	6 x 0.5	3.0	450	1.88	\$408.00
111507	7 x 0.5	3.5	525	2.19	\$476.00
111508	8 x 0.5	4.0	600	2.50	\$544.00
111509	9 x 0.5	4.5	675	2.81	\$612.00
111510	10 x 0.5	5.0	750	3.13	\$680.00
111512	12 x 0.5	6.0	900	3.75	\$684.00
111514	14 x 0.5	7.0	1050	4.38	\$798.00
111516	16 x 0.5	8.0	1200	5.00	\$912.00
111518	18 x 0.5	9.0	1350	5.63	\$1,026.00
111520	20 x 0.5	10.0	1500	6.25	\$1,140.00
111524	24 x 0.5	12.0	1800	7.50	\$1,368.00
111528	28 x 0.5	14.0	2100	8.75	\$1,596.00
111532	32 x 0.5	16.0	2400	10.00	\$1,824.00

200W In screed and Bathroom Heating Mat Only

Stock Code	Size (m)	Area (m ²)	Output (W)	Amps (A)	RRP \$ Incl.
112002	2 x 0.5	1.0	200	0.83	\$152.00
112003	3 x 0.5	1.5	300	1.25	\$228.00
112004	4 x 0.5	2.0	400	1.67	\$304.00
112005	5 x 0.5	2.5	500	2.08	\$380.00
112006	6 x 0.5	3.0	600	2.50	\$456.00
112007	7 x 0.5	3.5	700	2.92	\$532.00
112008	8 x 0.5	4.0	800	3.33	\$608.00
112009	9 x 0.5	4.5	900	3.75	\$684.00
112010	10 x 0.5	5.0	1000	4.17	\$760.00
112012	12 x 0.5	6.0	1200	5.00	\$780.00
112014	14 x 0.5	7.0	1400	5.83	\$910.00
112016	16 x 0.5	8.0	1600	6.67	\$1,040.00
112018	18 x 0.5	9.0	1800	7.50	\$1,170.00
112020	20 x 0.5	10.0	2000	8.33	\$1,300.00
112024	24 x 0.5	12.0	2400	10.00	\$1,560.00



Loose Wire Underfloor Heating Systems

Loose wire systems are the traditional form of Underfloor Heating and are the perfect solution for installing in small awkward areas.

Our loose wire Underfloor Heating systems offer the flexibility of loose wire installation with our superior heating cable, and an option for undertile or in screed.



Lifetime warranty

We are so confident in the quality of our loose wire Underfloor Heating cable that we give each system a warranty that lasts a Lifetime, with a 3 year warranty on our Thermostats.

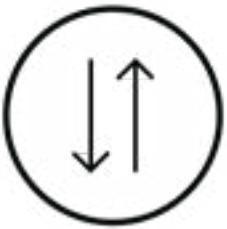

Variable output Underfloor Heating

The cable system allows you to space the heating cables yourself to achieve a desired layout and heat output per m². For larger areas directly undertile we would recommend an output of 150W/m² and for bathrooms, either above or below the screed, we would recommend an output of 200W/m².



Advanced heating cable

Our superior advanced cables ensures your heating system will last years to come as well as being robust and durable during the install process.



Cloth tape for fixing to the substrate

Both the undertile and in screed loose wire systems are supplied with a roll of cloth tape for taping the cable to the substrate.



Ideal for irregular shaped areas

The layout is totally flexible and can be designed to fit around furniture and fixtures in small or irregular shaped rooms.

Loose Wire Installation Overview

This diagram displays a typical bathroom layout with loose wire Underfloor Heating. The loose wire cable provides flexibility when running across the floor and is shown being held down with cloth tape.

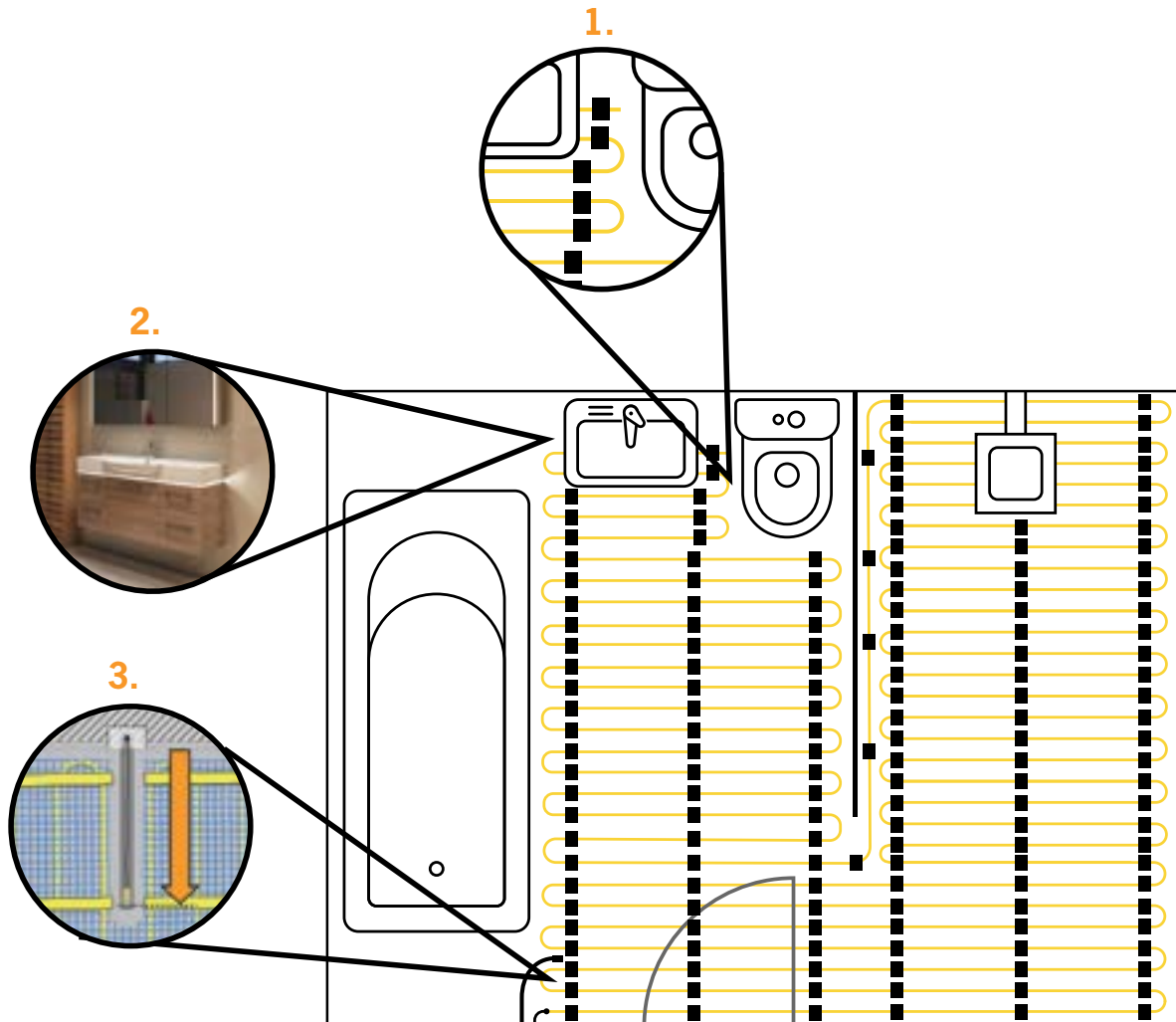

1. Wiring Flexibility

The loose wire cable allows you to run the cable across the floor and tape it to the substrate. Ensure even cable spacing across the room for an even heat feel.

2. Wall mounted fixtures

If you have a wall hung vanity always allow enough floor heating to run under the front of the vanity to ensure this floor area is warm.

3. Floor sensor and conduit

Ensure the floor sensor is installed in the conduit and placed equally centred between two runs of heating cable to provide an accurate floor temperature reading.

Cable Spacing Formula

The loose wire cable provides spacing flexibility to suit your room. It is important to maintain an even consistent spacing across the room to eliminate hot and cold spots.

The cable spacing formula below will help to work out the exact cable spacing. We recommend installing with an output of 150W/m² when undertile in areas outside the bathroom and 200W/m² for the bathroom. Minimum cable spacing is 50mm and maximum spacing is 100mm.

$$\frac{\text{Available floor space (m}^2\text{)} \times 100}{\text{Kit length (m)}} = \text{Cable spacing (cm)}$$

Installation Accessories

The loose wire heating cables can be fixed in position with one of three fixing methods. The cloth tape is the standard fixing method used on any substrate and is included as standard with all cables. The Thermoscreed system can also be installed using the Galvanised Fixing Profile or In screed Cable Mesh.



Cloth Tape

A 25m roll of cloth tape is included with all cables as a standard fixing method for use on any substrate.



Galvanised Fixing Profile

Galvanised steel fixing profile can be mechanically fixed to timber or concrete substrates. Allow 1m of fixing strip per 6m of heating cable. (Thermoscreed Cable Only)



In Screed Cable Mesh

A 4.5m² roll of loose lay mesh which is designed for loose laying over a waterproofed substrate. (Thermoscreed Cable Only)

Stock Code	Description	Size	Unit	RRP \$ Incl.
3255	Cloth Tape	36mm x 25m	Roll	Supplied free of charge with cable
3259	Galvanised Fixing Profile	25m	Roll	\$139.00
3263	In screed Cable Mesh	4.5m ²	Roll	\$79.00

Thermowire Underfloor Heating System

Thermowire is the traditional method of installing Underfloor Heating directly below your tiles utilising a loose wire system.

The Thermowire cable is ideal for use directly below the tiles in small awkward areas through providing flexibility and ease of installation.

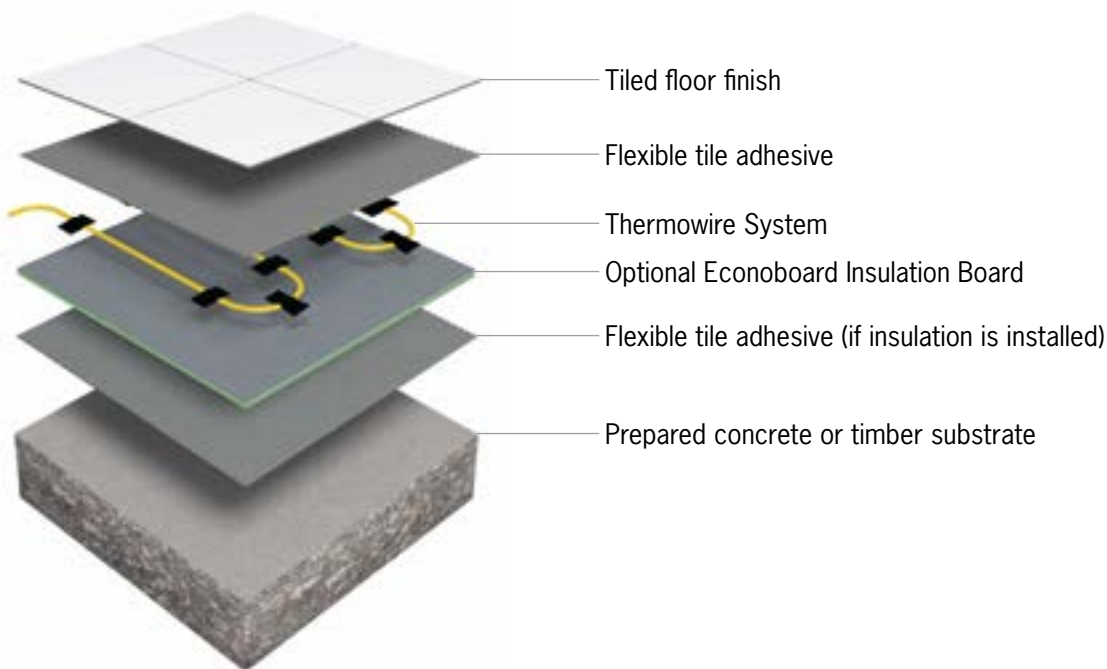

Undertile heating

The thin profile of Thermowire means that it can be installed in the layer of tile glue therefore not adding any additional height to your floor build up. It can also be covered with a layer of self-levelling compound to allow it to be used in conjunction with other floor finishes.



Robust thin heating cable

The Thermowire cable is only 3.5mm thick however it has a unique twisted twin construction which gives it the superior strength to last a lifetime.



Rapid heat up time

With the Thermowire cable installed directly below the tiles you will experience rapid warmth to your floors. We recommend installing with an output of 150w/m² when undertile in areas outside the bathroom and 200w/m² for the bathroom.

Thermoscreed Underfloor Heating System

thermoscreed
UNDERFLOOR HEATING

Thermoscreed is designed for use below your screed, ideal for creating a heat bank below your floor finish. Designed for use in 20 - 50mm screed layers.

Offering the flexibility of loose wire heating with a robust cable, designed to provide suitable heat performance through a screed layer.

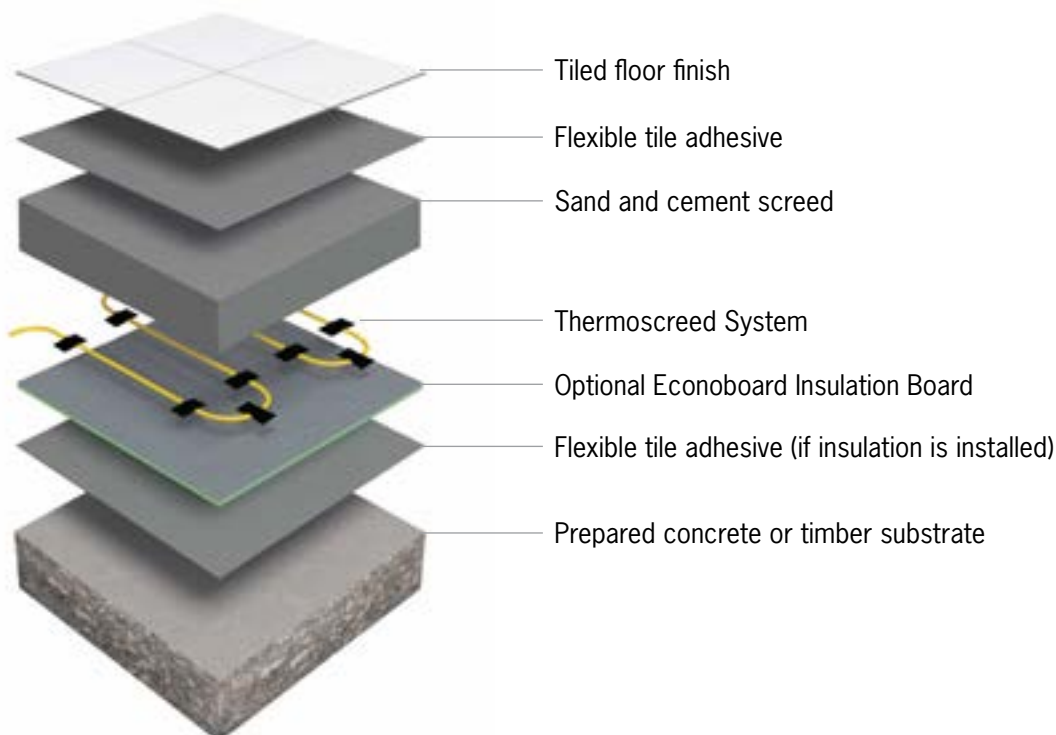

In screed heating

Suitable for installation in screeds of 20mm to 50mm and is recommended to be installed on top of insulation boards for improved heating performance. Suitable for use with sand and cement, or anhydrite or flow screeds.



Efficient storage heating

In screed systems have a slightly slower heat up and cool down time as opposed to undertile systems, and this varies based on the thickness of the screed. Thermoscreed creates an energy efficient thermal mass below your floor by warming the entire screed which continues to radiate heat upwards after the system is off.



Robust hard wearing cable

The advanced protective PVC coating on Thermoscreed cables protects the heating element during installation and during the screed pour. At 5.5mm thick the robust cable is designed to last a lifetime.

Loose Wire Underfloor Heating Standard Thermostat Kits

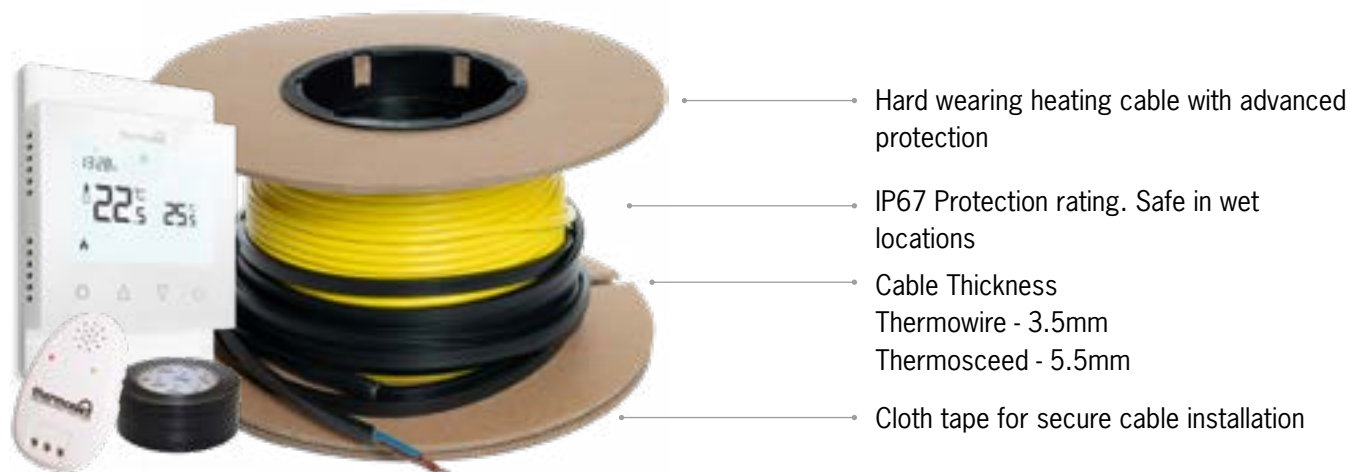

Standard Thermostat Kit Inclusions



Programmable Thermostat

Stock Code - 5220A

Fully programmable, 7-day thermostat, providing full control over your Underfloor Heating. More details on pages 52-53. Includes floor sensor and conduit.



Heating Cable Monitor

Stock Code - 6025

The cable monitor measures the cable integrity during installation and whilst the floor finish is being laid and will sound an alarm if damage occurs.



Roll of Cloth Tape

Stock Code - 3255

Cloth tape is used for securing loose runs of cable and holding down the corners of matting during installation.

Undertile Standard Control Kits



Thermowire Standard Control Kits (Formerly known as Vario)

Stock Code	Size (m)	Area (m ²)*	Output (W)	Amps (A)	RRP \$ Incl.
101502T	14	1.0 - 1.4	185	0.77	\$524.00
101503T	22	1.5 - 2.4	300	1.25	\$580.00
101504T	33	2.5 - 3.4	450	1.88	\$619.00
101506T	44	3.5 - 4.4	600	2.50	\$674.00
101508T	55	4.5 - 5.4	750	3.13	\$734.00
101510T	66	5.5 - 6.9	900	3.75	\$834.00
101512T	86	7.0 - 8.9	1200	5.00	\$944.00
101515T	110	9.0 - 10.9	1500	6.25	\$1,054.00
101518T	132	11.0 - 12.9	1800	7.50	\$1,214.00
101521T	154	13.0 - 14.9	2100	8.75	\$1,314.00
101524T	176	15.0 - 18.0	2400	10.00	\$1,434.00

*Based on approximately 150W/m² for installation directly below your tiles.

In screed Standard Control Kits



Thermoscreed Standard Control Kits

Stock Code	Size (m)	Area (m ²)* *	Output (W)	Amps (A)	RRP \$ Incl.
3050T	11.0	1.0 - 1.2	200	0.83	\$530.00
3051T	16.5	1.3 - 1.7	300	1.25	\$560.00
3052T	22.0	1.8 - 2.2	400	1.67	\$595.00
3053T	27.5	2.3 - 2.7	500	2.08	\$628.00
3054T	33.0	2.8 - 3.2	600	2.50	\$682.00
3055T	39.0	3.3 - 3.8	700	2.92	\$714.00
3056T	45.0	3.9 - 4.6	850	3.54	\$757.00
3057T	55.0	4.7 - 5.6	1000	4.17	\$814.00
3058T	69.0	5.7 - 6.8	1250	5.21	\$920.00
3059T	76.0	6.9 - 7.6	1375	5.73	\$994.00
3060T	94.0	7.7 - 9.4	1700	7.08	\$1,104.00
3061T	116.0	9.6 - 11.7	2100	8.75	\$1,175.00
3062T	144.0	11.8 - 14.4	2600	10.83	\$1,435.00
3063T	183.0	14.5 - 18.3	3300	13.75	\$1,850.00

**Based on approximately 200W/m² for installation below the screed.

To purchase a kit with a black thermostat (5226A) add a 'B' after the stock code. The price remains the same.

Loose Wire Underfloor Heating Dual Control Thermostat Kits

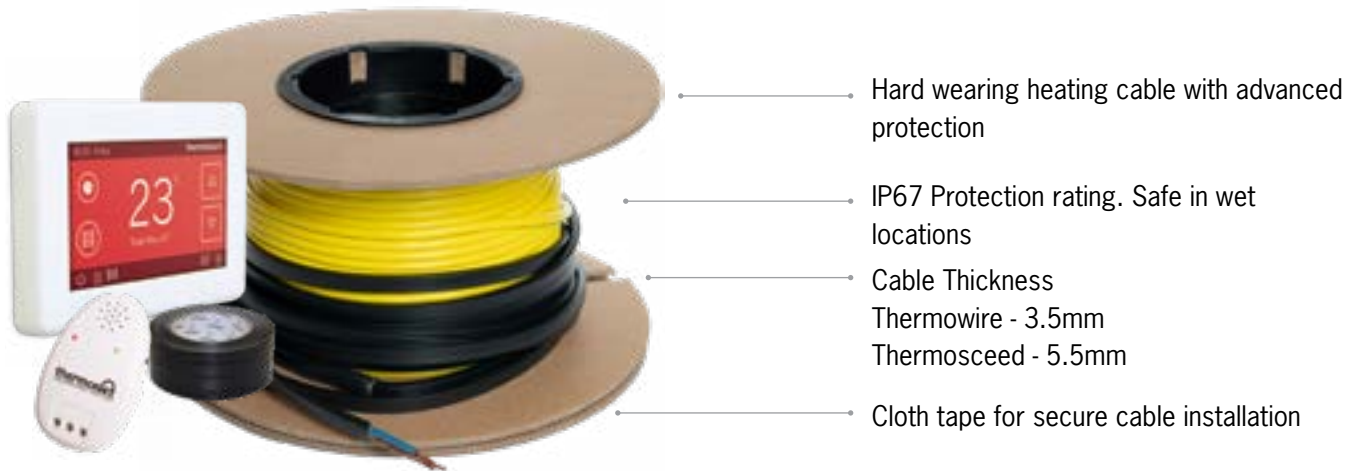

Dual Control Thermostat Kit Inclusions



Programmable Thermostat

Stock Code - 5245

Fully programmable dual thermostat, allowing you to control your Underfloor Heating and Heated Towel Rails on their own individual schedule. More details on pages 54-55.

Includes floor sensor and conduit



Heating Cable Monitor

Stock Code - 6025

The cable monitor measures the cable integrity during installation and whilst the floor finish is being laid and will sound an alarm if damage occurs.



Roll of Cloth Tape

Stock Code - 3255

Cloth tape is used for securing loose runs of cable and holding down the corners of matting during installation.

Undertile Dual Control Kits



Thermowire Dual Control Kits (Formerly known as Vario)

Stock Code	Size (m)	Area (m ²)*	Output (W)	Amps (A)	RRP \$ Incl.
101502TD	14	1.0 - 1.4	185	0.77	\$674.00
101503TD	22	1.5 - 2.4	300	1.25	\$730.00
101504TD	33	2.5 - 3.4	450	1.88	\$769.00
101506TD	44	3.5 - 4.4	600	2.50	\$824.00
101508TD	55	4.5 - 5.4	750	3.13	\$884.00
101510TD	66	5.5 - 6.9	900	3.75	\$984.00
101512TD	86	7.0 - 8.9	1200	5.00	\$1,094.00
101515TD	110	9.0 - 10.9	1500	6.25	\$1,204.00
101518TD	132	11.0 - 12.9	1800	7.50	\$1,364.00
101521TD	154	13.0 - 14.9	2100	8.75	\$1,464.00
101524TD	176	15.0 - 18.0	2400	10.00	\$1,584.00

*Based on approximately 150W/m² for installation directly below your tiles.

In screed Dual Control Kits



Thermoscreed Dual Control Kits

Stock Code	Size (m)	Area (m ²)* *	Output (W)	Amps (A)	RRP \$ Incl.
3050TD	11.0	1.0 - 1.2	200	0.83	\$680.00
3051TD	16.5	1.3 - 1.7	300	1.25	\$710.00
3052TD	22.0	1.8 - 2.2	400	1.67	\$745.00
3053TD	27.5	2.3 - 2.7	500	2.08	\$778.00
3054TD	33.0	2.8 - 3.2	600	2.50	\$832.00
3055TD	39.0	3.3 - 3.8	700	2.92	\$864.00
3056TD	45.0	3.9 - 4.6	850	3.54	\$907.00
3057TD	55.0	4.7 - 5.6	1000	4.17	\$964.00
3058TD	69.0	5.7 - 6.8	1250	5.21	\$1,070.00
3059TD	76.0	6.9 - 7.6	1375	5.73	\$1,144.00
3060TD	94.0	7.7 - 9.4	1700	7.08	\$1,254.00
3061TD	116.0	9.6 - 11.7	2100	8.75	\$1,325.00
3062TD	144.0	11.8 - 14.4	2600	10.83	\$1,585.00
3063TD	183.0	14.5 - 18.3	3300	13.75	\$2,000.00

**Based on approximately 200W/m² for installation below the screed.

To purchase a kit with a black thermostat (5246) add a 'B' after the stock code. The price remains the same.

Loose Wire Underfloor Heating Cable Only



Hard wearing in screed heating cable with advanced protection

IP67 Protection rating. Safe in wet locations

Cable Thickness
Thermowire - 3.5mm
Thermosceed - 5.5mm

Cloth tape for secure cable installation

Includes:

- ✔ Loose Wire Cable
- ✔ Cloth Tape
- ✔ Installation Guide with Warranty Form

Loose wire systems need to be wired to a thermostat. The loose wire cable only option is for use with a Wi-Fi or manual thermostat or when wiring multiple cables to one controller.



Undertile Heating Cable Only

Thermowire Undertile Heating Cable (Formerly known as Vario)

Stock Code	Size (m)	Area (m ²)*	Output (W)	Amps (A)	RRP \$ Incl.
101502	14	1.0 - 1.4	185	0.77	\$209.00
101503	22	1.5 - 2.4	300	1.25	\$265.00
101504	33	2.5 - 3.4	450	1.88	\$304.00
101506	44	3.5 - 4.4	600	2.50	\$359.00
101508	55	4.5 - 5.4	750	3.13	\$419.00
101510	66	5.5 - 6.9	900	3.75	\$519.00
101512	86	7.0 - 8.9	1200	5.00	\$629.00
101515	110	9.0 - 10.9	1500	6.25	\$739.00
101518	132	11.0 - 12.9	1800	7.50	\$899.00
101521	154	13.0 - 14.9	2100	8.75	\$999.00
101524	176	15.0 - 18.0	2400	10.00	\$1,119.00

*Based on approximately 150W/m² for installation directly below your tiles.

In screed Heating Cable Only



Thermoscreed In screed Heating Cable

Stock Code	Size (m)	Area (m ²)* *	Output (W)	Amps (A)	RRP \$ Incl.
3050	11.0	1.0 - 1.2	200	0.83	\$215.00
3051	16.5	1.3 - 1.7	300	1.25	\$245.00
3052	22.0	1.8 - 2.2	400	1.67	\$280.00
3053	27.5	2.3 - 2.7	500	2.08	\$313.00
3054	33.0	2.8 - 3.2	600	2.50	\$367.00
3055	39.0	3.3 - 3.8	700	2.92	\$399.00
3056	45.0	3.9 - 4.6	850	3.54	\$442.00
3057	55.0	4.7 - 5.6	1000	4.17	\$499.00
3058	69.0	5.7 - 6.8	1250	5.21	\$605.00
3059	76.0	6.9 - 7.6	1375	5.73	\$679.00
3060	94.0	7.7 - 9.4	1700	7.08	\$789.00
3061	116.0	9.6 - 11.7	2100	8.75	\$860.00
3062	144.0	11.8 - 14.4	2600	10.83	\$1,120.00
3063	183.0	14.5 - 18.3	3300	13.75	\$1,535.00

**Based on approximately 200W/m² for installation below the screed.



Thermofoil Underfloor Heating System

Thermofoil is an Electric Underfloor Heating foil designed for floating laminate, carpet and engineered timber floor finishes.

Bring the luxury feeling of Underfloor Heating and the simplicity of an electric system to engineered timber, laminate and carpet floors.



Lifetime warranty

We are so confident in the quality of Thermofoil, that we give each system a warranty that lasts a Lifetime, with a 3 year warranty on our Thermostats.

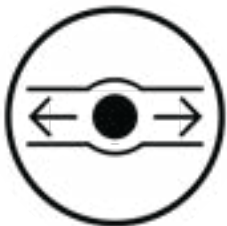

Efficient heat exchange foil

The double layer of foil in Thermofoil is specifically designed to protect the heating element and achieve an even spread of heat to the floor above.



Easy cut and return installation

The accessible cable loops are a unique feature of our foil system. They make cut and return installation quick and easy while protecting the heating element.



Continuous earth protection braid

Electrical safety is paramount and Thermofoil's continuous earth braid protection runs the entire length of the heating cable.



Minimal height build-up

The foil system is only 2.5mm thick with a low profile cold tail of only 4mm, which can be concealed within the insulation or underlay. Please note, the floor buildup will need to include underlay and overlay. These will increase your floor height build-up if an underlay and overlay is not already part of the floor build-up.



When installing under soft floor finishes such as carpet or engineered timber, please be sure to consult the floor finish manufacturer for guidance on compatibility and maximum temperature.

Thermofoil Underfloor Heating System

Thermofoil is the most advanced electric under laminate heating foil available. Innovations such as our exposed cable loops and continuous earth protection ensure an easy installation and total safety. Thermofoil is a versatile system that can be used in many different floor configurations.



Carpet floor solution

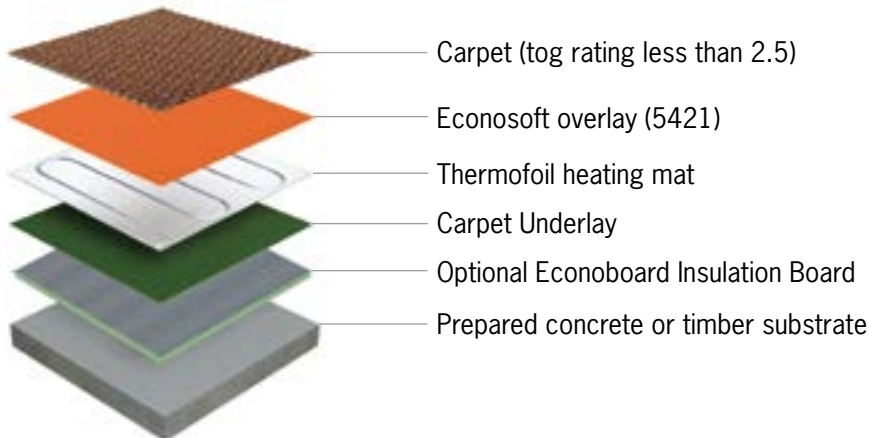

Floating timber floor solution

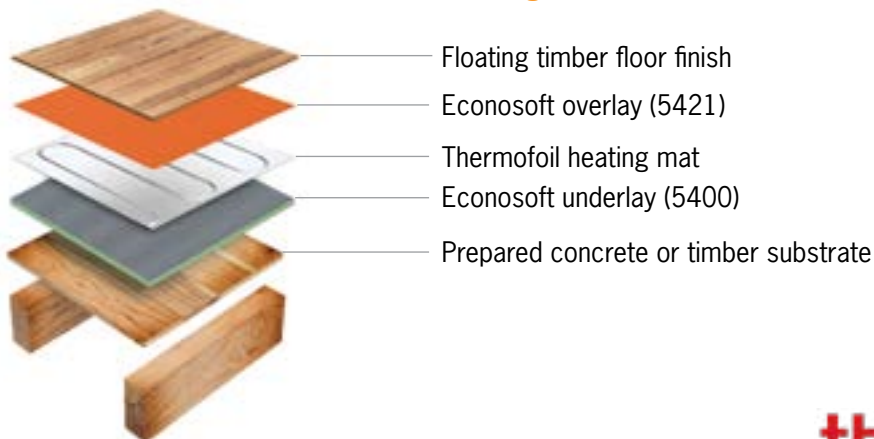

Thermofoil Heating System



Stock Code	Size (m)	Area (m ²)	Output (W)	Amps (A)	RRP \$ Incl.
121402	2 x 0.5	1.0	140	0.58	\$312.00
121403	3 x 0.5	1.5	210	0.88	\$375.00
121404	4 x 0.5	2.0	280	1.17	\$409.00
121405	5 x 0.5	2.5	350	1.46	\$475.00
121406	6 x 0.5	3.0	420	1.75	\$539.00
121408	8 x 0.5	4.0	560	2.33	\$719.00
121410	10 x 0.5	5.0	700	2.92	\$839.00
121412	12 x 0.5	6.0	840	3.50	\$879.00
121414	14 x 0.5	7.0	980	4.08	\$919.00
121416	16 x 0.5	8.0	1120	4.67	\$1,059.00
121418	18 x 0.5	9.0	1260	5.25	\$1,219.00
121420	20 x 0.5	10.0	1400	5.83	\$1,429.00
121424	24 x 0.5	12.0	1680	7.00	\$1,599.00

Remember to order your chosen Thermofoil system, a Thermostat (see pages 51-61) and the suitable underlay and overlay for the floor build-up.

Thermofoil overlay and underlay accessories

Overlay and underlay are essential for a long lasting floating heated floor construction.



Econosoft Underlay

All Thermofoil installations require a cushioning underlay. Econosoft is a 5mm cushioning underlay that can be used with any Thermofoil installation. This can be substituted with a standard carpet or hard floor underlay.



Econosoft Overlay

An essential cushioning overlay that also acts as a vapour and acoustic barrier and should be included above Thermofoil in every application.

Stock Code	Description	Size	Unit	RRP \$ Incl.
5400	Econosoft Cushioning Underlay	1200 x 500 x 5mm	10 Pack (6m ²)	\$169.00
5421	Econosoft Overlay	10m x 1m	Roll (10m ²)	\$299.00

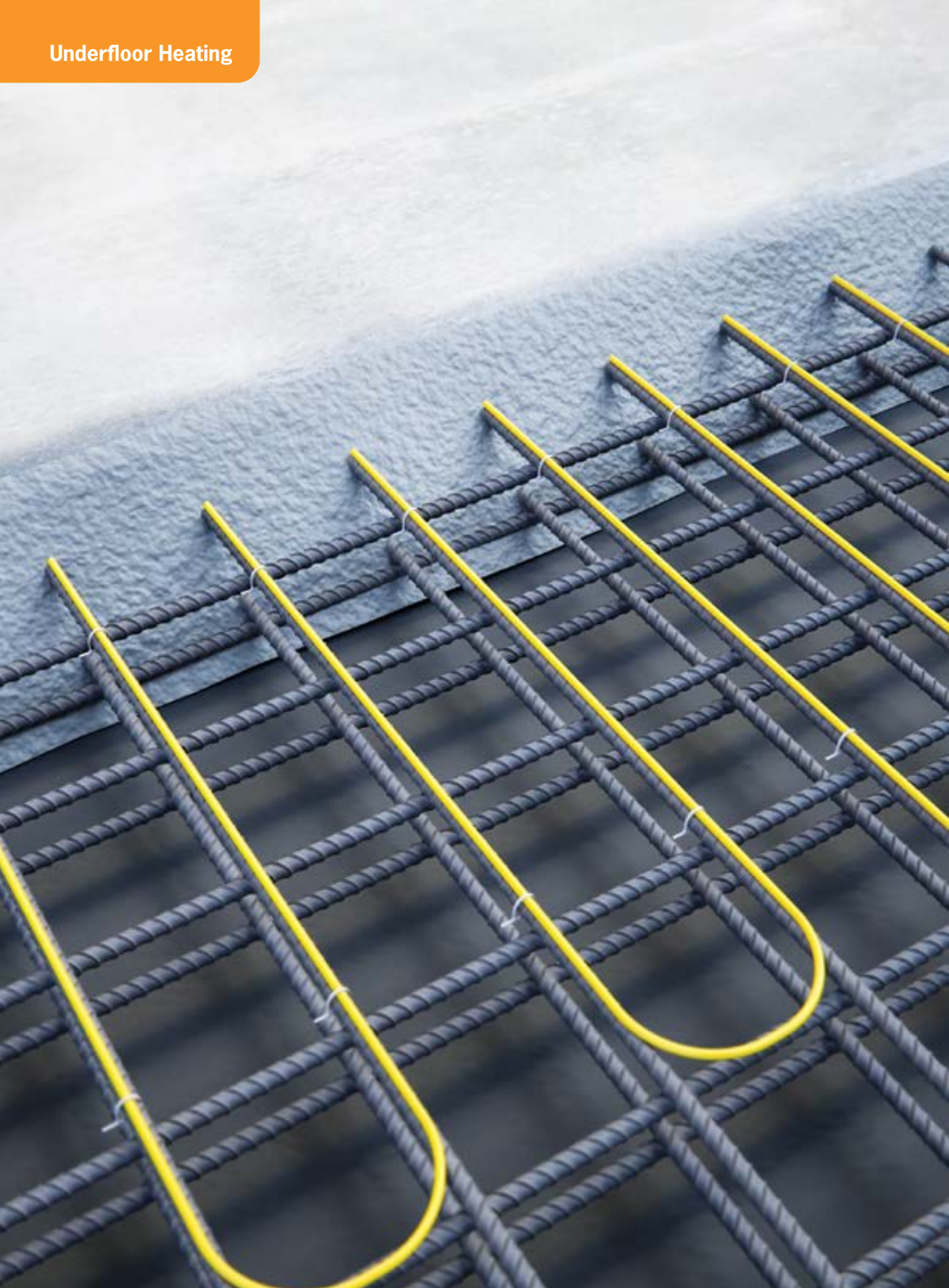

Thermoslab Underfloor Heating System

Versatile In Slab heating cable

Thermoslab is a brilliantly versatile, robust 7mm thick Underfloor Heating cable designed for use In Slab. Thermoslab heating will take some time to heat up, as much as 1-2 days, the slab however will then turn into a thermal heat mass and slowly release this heat up into the room. Due to the nature of the heating, where possible it is recommended to connect the slab heating to an off-peak meter to save on running costs. For more details on off-peak and the suitable thermostats to use refer to pages 58-59.

To work out which heating cable is required, multiply the square metres of your area by 5 to give the required linear metres of cable. This should give you a 200mm cable spacing, allowing the cable to be run on the concrete mesh.



Thermoslab Heating Cable Only

thermoslab
UNDERFLOOR HEATING

Stock Code	Length (m)	Area (m ²)	Output (W)	Amps (A)	RRP \$ Incl.
3138	10	2.0	300	1.25	\$299.00
3139	20	4.0	600	2.50	\$369.00
3141	30	6.0	900	3.75	\$419.00
3142	37	7.4	1100	4.58	\$469.00
3145	50	10.0	1500	6.25	\$539.00
3147	60	12.0	1800	7.50	\$599.00
3148	67	13.4	2010	8.38	\$669.00
3152	84	16.8	2500	10.42	\$719.00
3155	100	20.0	3000	12.50	\$809.00
3156	112	22.4	3350	13.96	\$1,039.00
3158	134	26.8	4020	16.75	\$1,139.00
3160	150	30.0	4500	18.75	\$1,339.00
3161	170	34.0	5100	21.25	\$1,569.00
3163	185	37.0	5500	22.92	\$1,699.00
3164	200	40.0	6000	25.00	\$1,849.00
3257	Pack of 100 Cable Ties - allow 3 cable ties per l/m of cable.				\$9.00

Underfloor Heating FAQs

We have put together a range of answers to the most frequently asked questions about Underfloor Heating systems. If you have a question that isn't answered here please give us a call or scan the QR Code to visit the Thermogroup Learning Centre.



What happens if it goes wrong or breaks under my floor?

There are no moving parts to an Electric Underfloor Heating system and cable failures are extremely rare, if installed correctly. A damaged cable can usually be located and repaired with minimal disruption.

Can I join two or more heating cables or mats to fit a larger area?

No, the heating cables or mats cannot be joined together however two or more elements can be connected in parallel to one thermostat. When connecting multiple cables or mats you need to ensure that the total load does not exceed the total load of your thermostat.

Can I cut the heating cable if I have excess?

No - never. Cutting the heating cable will alter the resistance and cause the element to overheat. If you cut the cable by accident, please call our technical helpline for assistance. Technical number is: 1300 989 464

How much does it cost to run an Electric Underfloor Heating system?

Every system installation is different due to the insulation value of the property, type of flooring used and the level of insulation below the heating system. For estimated running costs visit our online running cost calculator.

Do I need a contactor/snubber?

Thermogroup thermostats have a max load of 16amps. If your system exceeds this total load you will require a suitably rated contactor and snubber to ensure a safe and functional circuit.

Can I extend or shorten the cold tail?

Yes! The low profile cold tail can be shortened or extended up to 50m with a suitably rated twin and earth cable. We recommend that connections are accessible.

Can I install Underfloor Heating in the shower?

If your shower floor is tiled, yes you can run the heating cables into the shower area as this helps to dry out the shower and prevent mould growth. It is recommended that you do not start or end in the shower. Refer to page 15 for more details.

What should I do if I have leftover heating cable?

You should always measure the room accurately and choose a system that covers the available heating area. If you do have extra cable you can run it around the edge of the room (Min. spacing 50mm), in the shower or up the walls (behind the tiles if tiling with a cement based flexible tile adhesive).

Do I need to use a special adhesive to fit tiles over Underfloor Heating?

You will need to use a cement based flexible tile adhesive, however there is a wide variety available so ask your manufacturer or tile retailer for guidance.

Is electric heating safe in bathrooms? What about the water?

It is perfectly safe to install all Thermogroup Underfloor Heating systems in the bathroom, except the Thermofoil system. Our Underfloor Heating systems are all protected to IP67 or higher, which means they can be placed in any zone of a bathroom with no issues. The thermostat, however, should be installed away from water sources.

How do I control my Underfloor Heating system?

Every system should be connected to a Thermostat. You can have a simple, manual on/off version, but we recommend the use of a programmable heating thermostat with a heating schedule for total system control and greater efficiency.

Do I need to include thermal insulation as part of my floor?

We recommend the use of Econoboard insulation as it can halve running costs. The Underfloor Heating systems will still be able to work without the use of insulation however it will increase the heat up times and running costs.

Can Underfloor Heating be used as the primary heat source?

Yes, if you cover at least 80% of the floor area with the Underfloor Heating system, this can be used as the primary heat source in the room.

How long will it take for the floor to heat up?

Every situation is different due to the insulation value of the property, type of flooring used and the level of insulation below the heating system. For estimated heat up times refer to page 14.

What floor covering can I have on top of Underfloor Heating?

Underfloor Heating can be installed below almost any floor covering. There are different systems and build-ups for the different floor coverings so it is important to select the most suitable system. We recommend you check with the flooring manufacturer to ensure your floor covering is compatible with Underfloor Heating.

How long should the floor heating be left on for?

The length of time depends on your lifestyle, the system used and the desired temperature. The heating needs to have at least 2-4 hours to heat up but will vary depending on the floor build-up. For more details refer to page 14.

Does floor heating cause any problems to the tiles or floor covering?

No - if installed correctly the floor heating does not affect the floor covering. For soft floor finishes, such as vinyl, carpet and engineered timber, consult the floor finish manufacturer for guidance on compatibility and maximum temperature.

Does Underfloor Heating require any maintenance?

No. An Electric Underfloor Heating system does not have any parts that require maintenance. The thermostat will need to be programmed to suit your lifestyle and you can adjust this when you wish to.

Who installs Underfloor Heating?

Electrical regulations and laws differ in each state. Often the floor heating is installed by the electrician, tiler, builder or even the home owner. It is important to check local regulations relating to installing Underfloor Heating. The testing and wiring up of the floor heating needs to be completed by a qualified electrician.

Can you walk on the installed heating cables before the tiles are laid?

Whilst the cable is durable and will handle foot traffic we recommend reducing walking on unfinished floor surfaces to a minimum as a precaution. Avoid putting heavy objects with sharp edges (such as buckets of tile glue) down on the cable. Always ensure the mat monitor is installed and turned on.

Can I turn the heating on to make sure it heats up before the tiles are laid?

No. The heating cable needs to be encased in a cement layer to help spread the heat. Turning on the heating before the cement layer is applied will cause the cable to overheat and burn out. The heating cable needs to be tested by a qualified electrician to ensure no damage has occurred during installation.

What is the difference between single and double conductor heating cables and mats?

A single conductor mat or cable has only one cold tail which needs to be connected to the thermostat as opposed to a double conductor cable or mat which has a cold tail at both ends of the heating cable that needs to be connected to the thermostat. All of the Thermogroup Underfloor Heating cables have a single cold tail, making installation quicker and easier.

Can I use my floor heating on 'Off-Peak' electricity?

When using In Slab Heating, you can take advantage of the Off-Peak electricity tariff as heating the slab creates a thermal mass beneath your floor that allows for a slow continuous release of heat. Undertile and In screed heating systems have a more rapid heat up and cool down time, therefore are not suitable to be used with Off-Peak electricity.

Are there any special wiring requirements?

Your electrician will need to ensure that the amperage of the circuit is suitable for the size of the floor heating system that is being installed. The floor heating must also be installed on a RCD protected circuit.

Does the floor sensor have to be installed in the conduit?

We recommend the use of a conduit for the floor sensor so that in the event of a floor sensor failing or the thermostat being upgraded, the floor sensor can be replaced without damaging the floor covering. If this is not possible we recommend installing a second floor sensor as a spare.

Is the Underfloor Heating installed above or below the waterproofing?

To ensure a fully waterproof substrate it is recommended to lay the floor heating over the waterproofing. In a screed application, where the waterproofing is on top of the screed, an In screed heating system can be laid before the waterproofing.

What is the advantage of an In screed system over an Undertile system?

When floor heating is installed below the screed, it uses the screed as a heat bank, providing efficient heat in the room. It also provides a clear smooth substrate for the tiler to lay the tiles onto.

Additional warranty details are found on pages 150-154.



CONTROLS AND ACCESSORIES

Contents

Thermotouch 7.6iG Glass Programmable Thermostat	52
Thermotouch 4.3dC Dual Programmable Thermostat	54
Thermotouch Wi-Fi Programmable Thermostat	56
Thermotouch Manual Thermostats	58
Accessories	60
Thermostat FAQ's	61

Efficient heating controls that help you save money

Our Thermostats provide accurate floor and ambient temperature control combined with a heating schedule that only heats when you need it and helps to reduce your running costs.



Fully programmable

Create an on demand heating schedule to provide heat only when you need it.



Accurate control

Accurate ambient and floor sensors provide total control over your heating system.



Easy installation

Easy installation into the mains electricity supply.



Sensor and conduit

All thermostats include a floor sensor and conduit. The conduit is provided for the sensor installation.



Range of options

Our range includes options from Programmable to Dual Control, Wi-Fi and even Manual thermostats.



Three year warranty

All of our thermostats are covered by a three year replacement warranty.

Thermotouch 7.6iG Glass Programmable Thermostat

Have full control over your Electric Underfloor Heating system with the Thermotouch 7.6iG fully programmable glass thermostat

The Thermotouch 7.6iG Programmable Thermostat features a fully programmable 7 day heating schedule with 6 heating events every day of the week. The ice white and piano black glass fascias and clean lines are a perfect match for any modern interior.



Fully programmable

The Thermotouch 7.6iG Programmable Thermostat features a fully programmable 7 day heating schedule with 6 heating events every day of the week.



Portrait or landscape mounting

Thermotouch 7.6iG is supplied with a portrait backing plate as standard. However, if required, you can purchase the landscape mounting plate.



Sensor mode

Thermotouch 7.6iG is supplied with a floor sensor probe and the option for using it's ambient sensor to ensure total control over your heating system.



Manual mode

Thermotouch 7.6iG also features a simple to use manual function that allows you to manually control the temperature of your Underfloor Heating.

Thermotouch 7.6iG Glass Programmable Thermostats

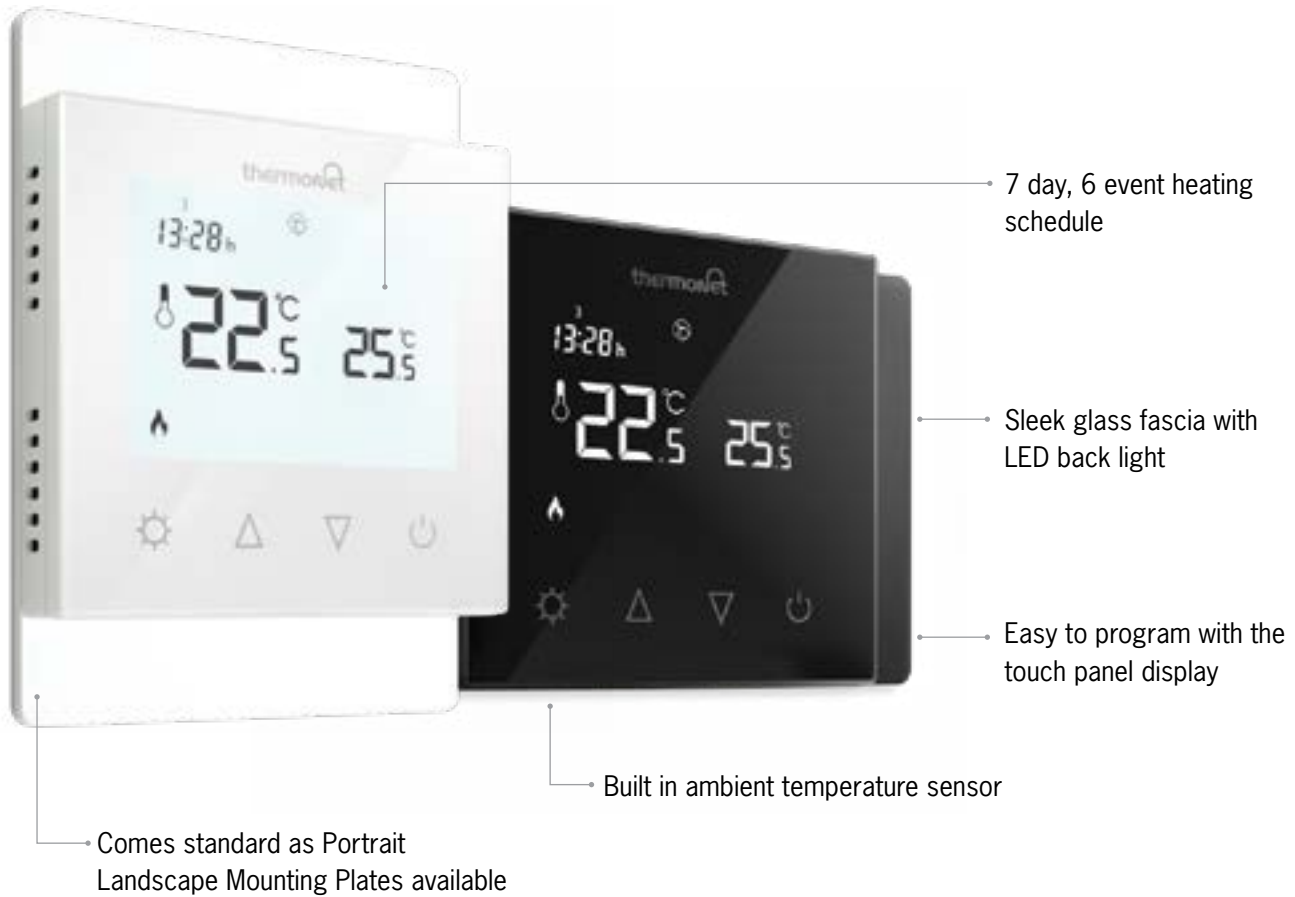

Stock Code	Colour	Size W x H x D (mm)	IP Rating	Max Load	RRP \$ Incl.
5220A*	Ice White	85 x 115 x 46 (26mm in wall)	IP30	16A	\$315.00
5226A	Piano Black	85 x 115 x 46 (26mm in wall)	IP30	16A	\$315.00

Stock Code	Description	Size W x H x D (mm)	RRP \$ Incl.
5221	White Landscape Mounting Plate	115 x 86 x 5	\$27.00
5223	Black Landscape Mounting Plate	115 x 86 x 5	\$27.00

*5220A Thermostat included as standard in all Underfloor Heating T-Kits - pages 25 and 37.

Thermotouch 4.3dC Dual Programmable Thermostat

Thermotouch 4.3dC is a dual thermostat that can control both your Underfloor Heating and Electric Heated Towel Rail or Mirror Demister.

The Thermotouch 4.3dC has been designed to deliver an easy to use Electric Underfloor Heating thermostat that has all the functionality required yet is simple to operate. Control your Electric Underfloor Heating and an additional appliance, such as an Electric Heated Towel Rail or Mirror Demister. The second relay operates an independent timer allowing separate heating schedules.



Dual relay controls

Thermotouch 4.3dC features two independent relays which allows you to control your Underfloor Heating and towel rail on separate on/off heating schedules.



Economical heating schedule

Set up an energy efficient, on demand heating schedule for your Underfloor Heating and an optional additional appliance.



Smart boost settings

Temporarily override your heating schedule until the next scheduled time for the Underfloor Heating and for up to four hours on your Heated Towel Rail. The Thermotouch will then revert back to your heating schedule.



Multiple sensor compatibility

Whilst the Thermotouch 4.3dC is supplied with a floor sensor, it is also compatible with the most popular floor sensors on the market making it suitable as an upgrade for your current thermostat.



Flexible heating schedule

The Thermotouch 4.3dC features a fully programmable 7 day heating schedule with 6 heating events every day of the week.

Thermotouch 4.3dC Dual Programmable Thermostat



Stock Code	Colour	Size W x H x D (mm)	IP Rating	Max Load	RRP \$ Incl.
5245*	Ice White	129 x 88 x 48 (31mm in wall)	IP30	20A**	\$465.00
5246	Satin Black	129 x 88 x 48 (31mm in wall)	IP30	20A**	\$465.00

* 5245 Thermostat included as standard in all Underfloor Heating TD-Kits - See pages 27 and 39.

**16 Amp relay for the Underfloor Heating and 5 amp relay for the second appliance. Max total load of 20 amps.

View Thermorail Heated Towel Rail Timers on pages 116-117.

Thermotouch 5235W Wi-Fi Programmable Thermostat

An Underfloor Heating thermostat that allows you to control your Electric Underfloor Heating system remotely

The Thermotouch 5235W allows you to control your Underfloor Heating either via the colour touch screen or remotely through an app on your smart phone. The thermostat can be mounted landscape or portrait and the sleek design is a perfect match for any room.

The 5235W is a single relay unit and therefore cannot be used for controlling both your Underfloor Heating and Heated Towel Rail.



Wi-Fi enabled - Control from anywhere

Control your Underfloor Heating from anywhere via your smartphone.* Control from your apple or android smartphone with the SWATT app.

*Internet connection required



Control multiple thermostats from one app

The SWATT app allows you to control multiple thermostats on one app. This effectively allows you to control all the thermostats in your home via the one portal delivering effortless control.



Multi user control

As well as having multiple thermostats controlled by one app, you can also connect up multiple users to the one app login. This means all your family members or co-workers can log in to the one account to control the same thermostats via the app.



Multiple heating modes

The 5235W features several different heating modes to give you ultimate control over your heating.



Fully programmable

The Wi-Fi thermostat is fully programmable both via the app and on the thermostat unit. This allows you to create your own personalised heating schedule based around your lifestyle and desired comfort levels.

Thermotouch 5235W Wi-Fi Programmable Thermostat



Stock Code	Colour	Size W x H x D (mm)	IP Rating	Max Load	RRP \$ Incl.
5235W	White	84 x 115 x 40 (22mm in wall)	IP21	16A	\$465.00



Thermotouch Manual Thermostats

Thermotouch Manual Thermostats are designed for application where only an on/off function is required to control the floor temperature, typically when using off-peak or home automation.

The manual thermostat range allows you to set a temperature for your Underfloor Heating and then switch the heating via a simple on/off switch. In the case of using off-peak or home automation, the manual thermostat allows you to set your desired temperature and then control the on/off either by your home automation system or the switching of the off-peak power.



Manual control

Thermotouch manual thermostats feature a simple to use manual function that allows you to manually control the temperature of your Underfloor Heating. This makes the manual thermostats ideal for use with slab heating when connected to off-peak power as the thermostat is only on during the off-peak period.



Sensor mode

The Thermotouch manual thermostats are all supplied with a floor sensor and conduit. The 5215/5216 manual thermostats also include a built in ambient sensor.



Back box supplied

The 5215, 5216 and 5250 are supplied with a back box for use with plaster walls for ease of installation. Please note these thermostats are designed for a EU backbox and are not designed to fit a standard Australian mounting plate. The 5291 is a DIN-Rail Thermostat designed to mount in your electrical board.



Use with home automation

Thermotouch 9.2mG has the function to be set to “On as Before”, allowing you to set your comfort level and use it with off-peak electricity or Home Automation systems. The other thermostats can simply be left in the on position for use with home automation/off-peak.

Thermotouch 9.2mG Glass Manual Thermostat



The 5215/5216 Manual Thermostat offers simple on/off controls and easy temperature adjustment. There are also some advanced settings including temperature limits and an ambient temperature sensor option. The sleek glass fascia makes it perfect for use in high visibility locations.

Thermotouch 5250 Manual Dial Thermostat



The 5250 Manual Thermostat features a simple on/off switch and a manual temperature dial. The red light indicator shows when the heating is operating. The 5250 is floor sensing only.

Thermotouch 5291 Manual DIN-Rail Thermostat



The 5291 Manual Thermostat features a simple on/off switch and a temperature dial. The 5291 is designed to be mounted in your electrical box. The red light indicator shows when the heating is operating. The 5291 is floor sensing only.

Stock Code	Colour	Size W x H x D (mm)	IP Rating	Max Load	RRP \$ Incl.
5215	Ice White	85 x 85 x 46 (31mm in wall)	IP30	16A	\$259.00
5216	Piano Black	85 x 85 x 46 (31mm in wall)	IP30	16A	\$259.00
5250	White	86 x 86 x 50 (26mm in wall)	IP30	16A	\$199.00
5291	White	36 x 86 x 58 (48mm in electrical board)	IP20	16A	\$285.00

Electrical Accessories



Underfloor Heating Cable Monitor

Code: 6025*

For cable integrity monitoring during installation. Supplied with every kit purchased.



Spray Adhesive

Code: 6026

Useful for matting and loose wire installations where additional adhesion is required.



Floor Sensor Probe

Code: 5266/5269**

Supplied with every Thermostat and is designed to provide accurate floor temperature control.



Contactor and Snubber

Code: 5279/5280/5286

Used to switch loads greater than 16 amps.



Snubber for use with Contactors

Code: 5281

The snubber prevents power spikes from passing through the contactor to the floor heating. Supplied with every contactor.



Cable Repair Kit

Code: 5270

To extend the cold tail or repair Underfloor Heating cables (Professional use only)

Stock Code	Description	Unit	RRP \$ Incl.
6025*	Underfloor Heating Cable Monitor	ea	\$39.00
6026	Spray Adhesive 500ml (10m ²)	ea	\$45.00
5266**	Thermostat Floor Sensor Probe 10k Ω	ea	\$38.00
5269**	Thermostat Floor Sensor Probe 12k Ω (5235W and 5291 only)	ea	\$38.00
5267	Flexible Floor Sensor Conduit	1.8 Lm	\$29.00
5279	25Amp Contactor with Snubber	ea	\$199.00
5280	40Amp Contactor with Snubber	ea	\$310.00
5286	63Amp Contactor with Snubber	ea	\$375.00
5281	Snubber for use with Contactors	ea	\$35.90
5270	Cable Repair Kit	ea	\$38.00
6994	Plastic EU Thermostat Back Box	ea	\$20.00
5412	Cold Tail Extension Wire	Lm	\$16.00

*A 6025 is supplied at no charge when purchasing heating cable and a controller.

**Floor sensors and conduits are supplied with all thermostats.

Thermostat FAQs

We have put together a range of answers to the most frequently asked questions about Underfloor Heating controllers. If you have a question that isn't answered here please give us a call or scan the QR Code to view Thermogroup Learning Centre.



What is a floor sensor?

A floor sensor is a small probe that is installed beneath the floor finish, between two runs of heating cable. This is connected to the Thermostat and gives an accurate reading of the floor temperature. The floor sensor can be extended up to 50m.

What temperature should I set my Underfloor Heating at?

Every situation is different however it is recommended to set your Underfloor Heating to 24°C to begin with. After testing for several days, increase or decrease the temperature to find your comfort temperature. Please note a decrease of 1°C may not affect the comfort or warmth of the floor enough to make it noticeable but can help to reduce running costs.

What is a contactor and snubber? Do I need to use one?

Thermogroup Thermostats have a max load of 16Amps. If your Underfloor Heating system exceeds this total load, you will require a suitably rated contactor/snubber to ensure a safe and functional circuit. A contactor is designed to switch these larger loads. A snubber must be used as this absorbs any electrical surges that could disrupt the memory of the thermostat.

Can I control multiple zones with one controller?

No, each zone that you want to have individual control over needs to have it's own separate controller.

What is an Eco Temperature?

The Eco temperature is a lower temperature that is set for the 'Off' period on the Thermostat. This is normally set at a temperature between 15-18°C. This means that the heating will still come on if the temperature drops below this, even during an 'Off' period, ensuring the floor heating will not be trying to heat from freezing for each 'On' period.

How much does it cost to run an Electric Underfloor Heating system?

Every system is different because of the insulation value of the property, type of flooring used and the level of insulation below the heating system. For estimated running costs please view our online calculator.

Do I need to purchase a floor sensor?

No, every Thermostat is supplied with a compatible floor sensor so this does not need to be purchased separately.

What is the difference between an Underfloor Heating controller and a towel rail controller?

An Underfloor Heating controller (Thermostat) allows you to have control over the temperature of your floor whereas a towel rail controller is only a timing device (On/Off) and does not allow for any control over the temperature.

Can I control my Underfloor Heating using home automation?

Yes, ensure that you purchase one of the manual thermostats (see page 59) with your Underfloor Heating and this can be connected to and controlled by your home automation system.

Can I control my Underfloor Heating and towel rail from one controller?

Yes, with our Thermotouch 4.3dC dual control thermostat, you can individually control both your Underfloor Heating and towel rail from the single controller. See pages 54-55.

What is the flexible conduit for? Do I need to install it?

We recommend that the floor sensor is installed in the flexible conduit so that if the floor sensor fails or if you choose to upgrade your thermostat later the floor sensor can be removed and replaced without damaging the floor covering.

Additional warranty details are found on pages 150-154.



Insulation

Contents

Econoboard Coated Insulation	64
Econoboard Uncoated Insulation	66

Key benefits of Econoboard Insulation

Econoboard insulation is recommended for an energy efficient Electric Underfloor Heating system. A layer of Econoboard will help prevent heat loss into the substrate and ensure faster heat up times, as well as providing a stable, flat substrate for Underfloor Heating.



50% increase in efficiency

Improve the efficiency of Electric Underfloor Heating by up to 50% by minimising heat loss into the substrate and ensuring faster heat-up times.



Multiple Applications

Econoboard offers an easy to install solution for both concrete or timber substrates and can be used on both wall and floors.



Lifetime warranty

Econoboard is warranted against material defects for the lifetime of the original floor covering under which it is installed.

Without insulation



Heat loss into the substrate

Without insulation boards, heat energy is lost into the substrate before radiating up through the floor into the room. This is wasted energy.

With insulation



Improved efficiency and comfort

Econoboard reflects the heat energy up through the floor, resulting in increased efficiency and much lower running costs.

Econoboard Coated Insulation Boards

Manufactured using a high-density extruded polystyrene core and a polymer modified, fiber reinforced cement coating on both sides. Econoboard Coated adds rigidity and strength to a timber substrate.

Econoboard Coated is the recommended insulation board for use in wetrooms that are being waterproofed.

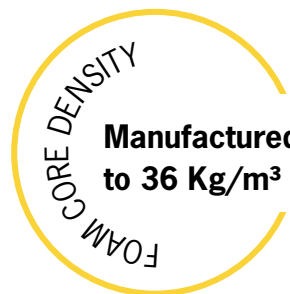
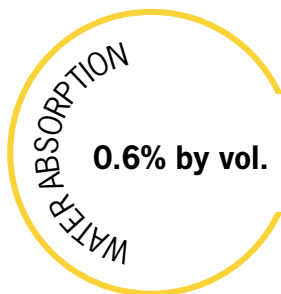
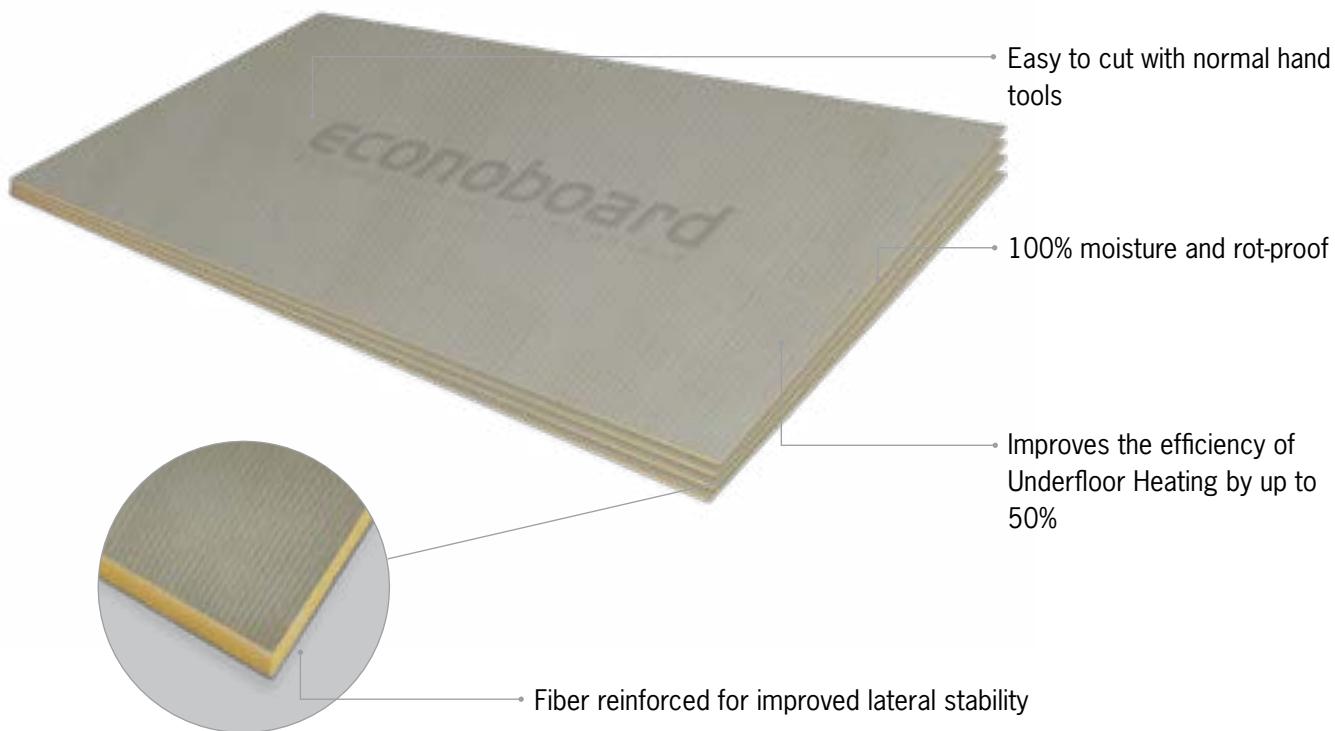

Installation Overview

Using Econoboard Coated and our range of fixing accessories quickly creates an ideal, stable substrate for tile adhesive and Underfloor Heating. It can be used on floors and walls and is 100% rot-proof which makes it ideal for use in bathrooms and wetrooms.

1. Ensure the substrate is secure and free from dust and any debris.
2. Cut boards to size with a sharp blade and position over the floor area in an offset brick pattern.
3. For fixing to a timber substrate use fixing screws and washers at 300mm centers. For fixing to a concrete substrate glue down using a full bed of cement based tile adhesive mixed to the manufacturers specifications.

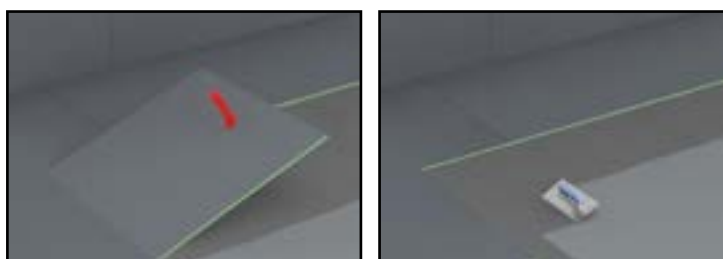
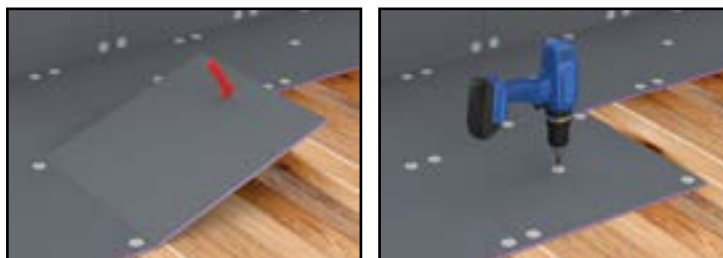

Stock Code	Thickness (mm)	Board Size (m)	Board Area (m ²)	Pack Quantity	Pack Area (m ²)	R Value m ² k/w	RRP \$ Incl.
6106	6	1.2 x 0.6	0.72	8	5.76	0.15	\$315.00
6110	10	1.2 x 0.6	0.72	6	4.32	0.27	\$315.00

Accessories



Reinforcing Tape

Reinforcing tape is used to help seal the joints between the boards when waterproofing over the Econoboard. Allow 2m of tape per board.



Zinc Fixing Washers

The zinc fixing washers are used when screwing Coated Econoboard to a timber substrate to give a large surface area for holding down the board. Screws are not supplied. Allow 10 washers per board.



Fixing Washers and Screws

The fixing washer and screw packs include both the zinc fixing washers and screws for fixing down the boards to a timber substrate. Allow 10 washers/screws per board.

Stock Code	Description	Unit	RRP \$ Incl.
6015	100mm Reinforcing Tape - 25m roll	ea	\$64.00
6016	Zinc Fixing Washers (35mm)	pk 100	\$49.00
6022	Fixing Washers (32mm) and Screws	pk 100	\$53.00

Econoboard Uncoated Insulation Boards

Cost effective thermal insulation board for concrete and screed substrates. Improves insulation and reduces heat loss into the substrate. Available in 6mm or 10mm boards, Econoboard gives you maximum insulation with a minimal height build up - ideal for refurbishment application when installed onto concrete subfloors. Econoboard Uncoated is not suitable to be screwed down.

Econoboard Uncoated is not suitable for waterproofing to be applied onto. For wetroom applications with waterproofing, we recommend Econoboard Coated.

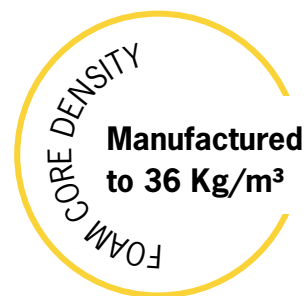
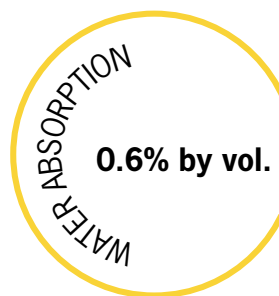
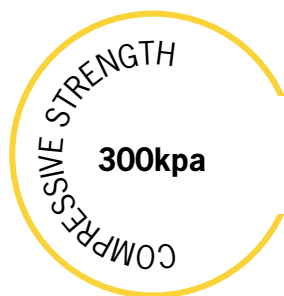
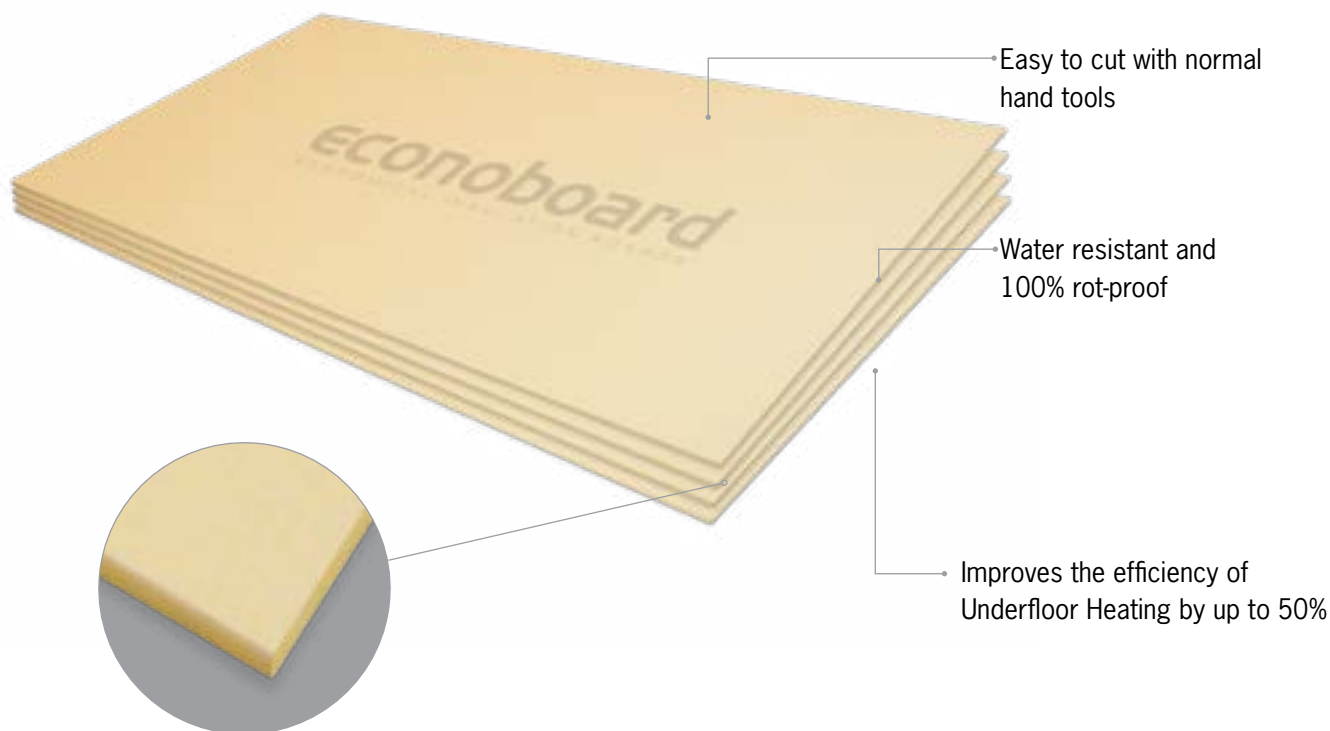

Installation Overview

Solid concrete floors and screeds absorb the cold and damp from below. Econoboard should be used before tiling to inhibit moisture and prevent heat loss into the substrate. Ideal for under tiled floors on concrete subfloors. For wetroom applications we recommend Econoboard Coated.

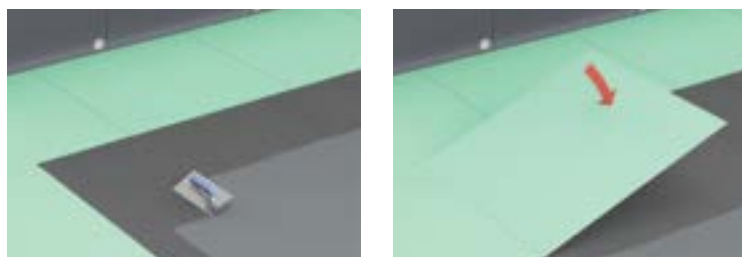

1. Ensure the concrete substrate is free from dust and any debris.
2. Mix tile adhesive according to manufacturer guidelines and spread on substrate with a notched trowel. Ensure the adhesive has the correct moisture level and the boards are laid before the glue skins.
3. Place in an offset brick pattern and fix in position by pressing the boards firmly into the adhesive.

Stock Code	Thickness (mm)	Board Size (m)	Board Area (m ²)	Pack Quantity	Pack Area (m ²)	R Value m ² k/w	RRP \$ Incl.
6012	6	1.2 x 0.6	0.72	20	14.4	0.18	\$499.00
6014	10	1.2 x 0.6	0.72	10	7.2	0.3	\$369.00

Econoboard Uncoated Acoustic Properties

Econoboard Uncoated Insulation boards will help to absorb impact sound resulting in decreased noise pollution, reducing impact sound by up to 20dB!

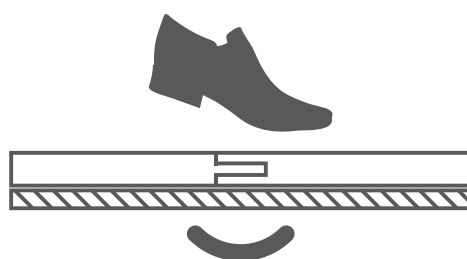

Additional warranty details are found on pages 150-154.



Space Heating

Contents

TF1800 Fan Heater	69
TF2400 Fan Heater	70
Heated Carpet Mat	71

TF1800 Fan Heater

The Thermofan TF1800 boasts intelligent energy saving controls, and its slimline design and touchscreen controls make it a perfect addition to any modern home. The TF1800 is fully programmable, allowing you to set when you want it on every day of the week and at your desired temperature.

Alternatively, the manual mode can be selected which allows you to set your comfort temperature and the Thermofan will heat as required, using the presence sensor to maintain this temperature. The presence sensor is designed to reduce energy consumption as it automatically lowers the temperature when no-one is detected in the room and comes back to the set comfort temperature when movement is detected again.

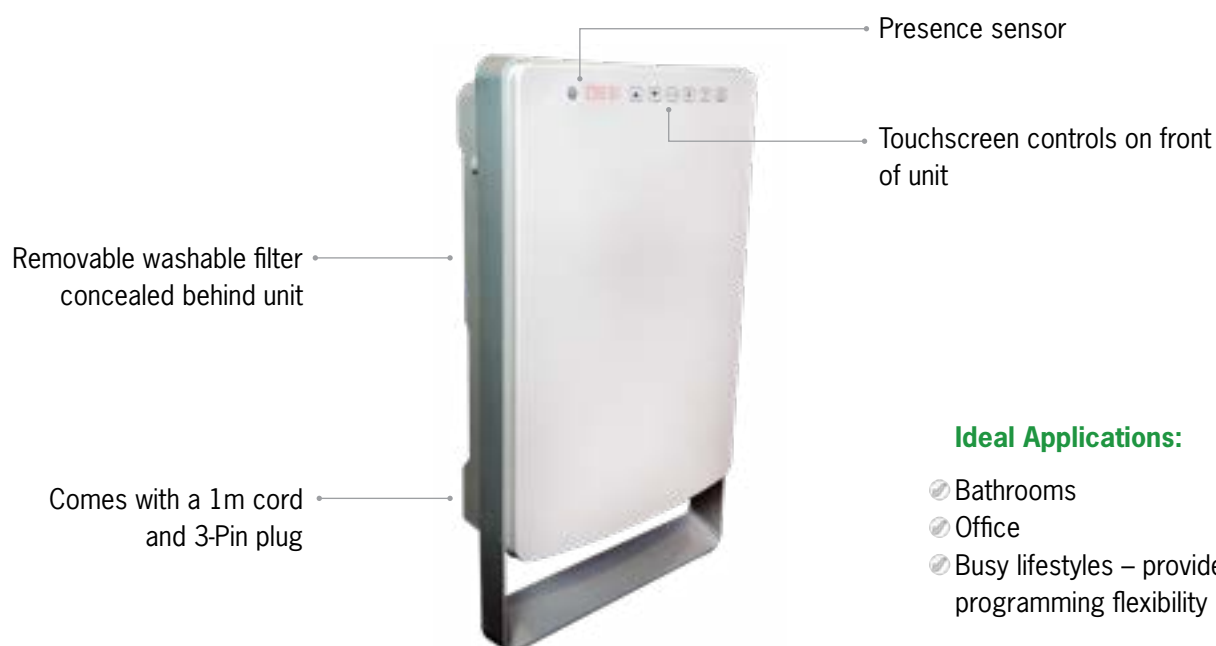

Ideal Applications:

- ☑ Bathrooms
- ☑ Office
- ☑ Busy lifestyles – provides full programming flexibility

Stock Code	Size (mm)	Output (W)	Room Size (m ²)	IP Rating	RRP \$ Incl.
TF1800	H450 x W270 x D110	1800	Up to 15	IP24	\$529.00

Wiring Method Standard as plug-in. Can be hard-wired if required.

Ease of Operation Complex

Programming Option Fully programmable with touchscreen controls

Warranty Two years

Finish Colour White with grey surround

TF2400 Fan Heater

The Thermofan TF2400 is a compact and sleek down flow heater available in a Stainless Steel or white finish. The unit features a metal case which is built to last and is operated by a pull switch. The fan heater provides an instant heat source with low noise level, helping to rapidly warm any room in the home.

The TF2400 unit is simple and quick to install on a wall, ideal for above doorways, and comes pre-fitted with a lead and 3-pin plug or can be hard-wired if required.

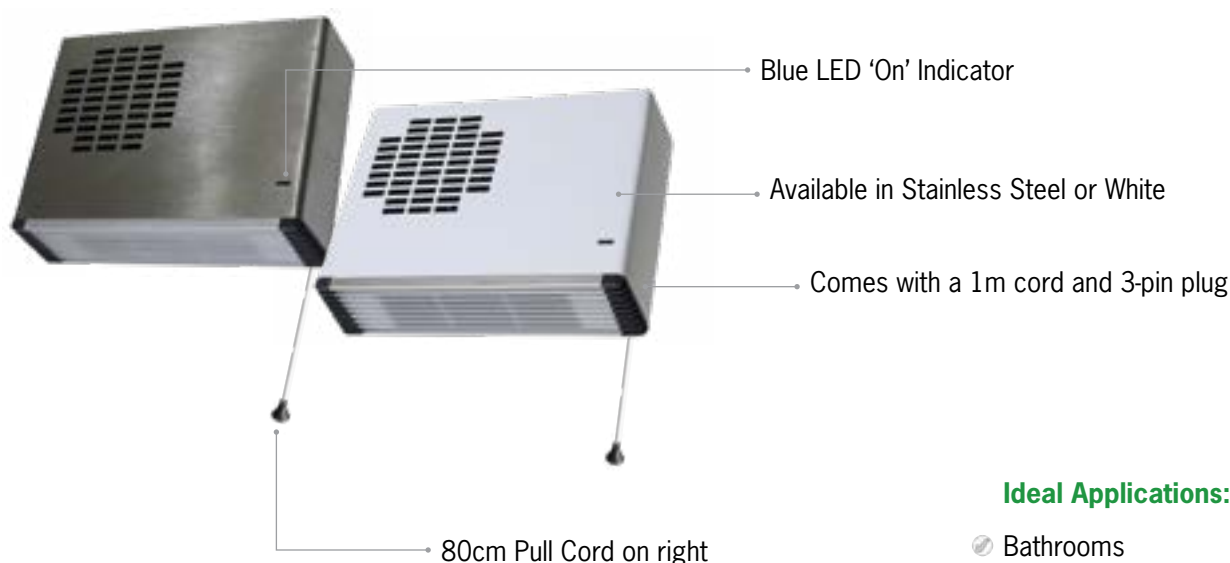

Ideal Applications:

- Bathrooms
- Hotels
- Classrooms
- High-wall Mounting

Stock Code	Colour	Size (mm)	Output (W)	Room Size (m ²)	IP Rating	RRP \$ Incl.
TF2400S	Stainless Steel	H200 x W270 x D110	2400	Up to 16	IPX0	\$259.00
TF2400W	White	H200 x W270 x D110	2400	Up to 16	IPX0	\$259.00

Wiring Method	Standard as plug-in. Can be hard-wired if required.
Ease of Operation	Simple
Programming Option	Pull cord on/off switch
Warranty	Two years
Finish Colour	Stainless Steel (TF2400S) / White (TF2400W)

Heated Carpet Mat

Add the warm feeling of Underfloor Heating to your home or office without having to replace your floor.

Thermomat heated carpet mats are a simple plug-in heating mat ideal for use under your desk, controlled by a foot operated switch on the cord (1.8m long cord).



Stock Code	Size (mm)	Output (W)	Colour	RRP \$ Incl.
6050	W600 x D400 x H10	75	Anthracite	\$215.00



Additional warranty details are found on pages 150-154.

thermomat
HEATED CARPET MAT

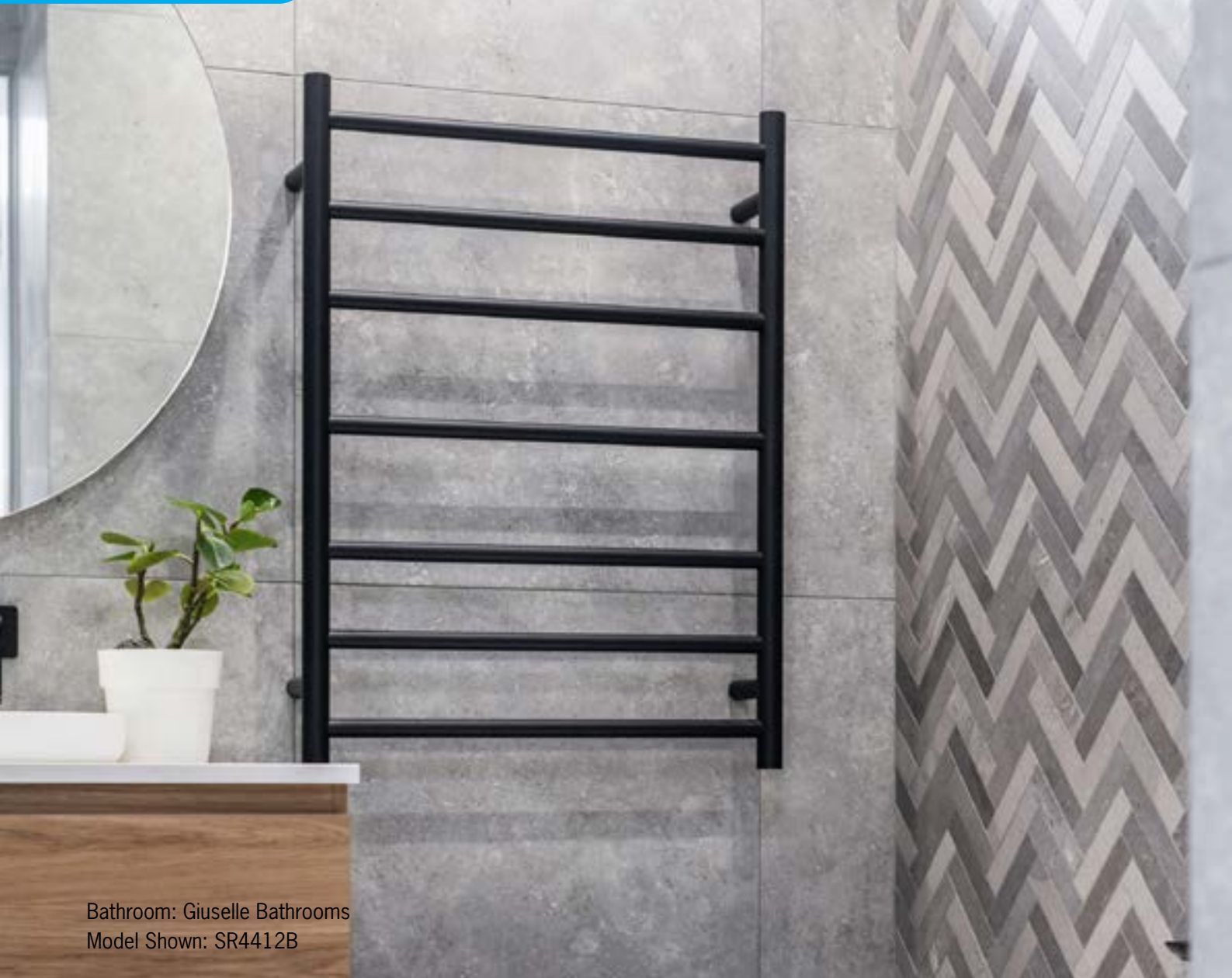

Bathroom: Giuselle Bathrooms
Model Shown: SR4412B

Heated Towel Rails

Contents

Types of Heated Towel Rails	74	240V Free Standing Range	113
Thermorad	76	240V Heritage Rail	114
12V Single Bar Range	81	Thermorail Custom Plated Colour Finishes	115
12V Vertical Bar Range	86	Thermorail Timers	116
12V Ladder Range	92	Non-Heated Range	118
240V Vertical Bar Range	95	Multiflex Wiring Explained	120
240V Ladder Range	96	Positioning your Thermorail	121
240V Swivel Range	110	Heated Towel Rail FAQ's	122
240V Floor to Ceiling Rail	112		

Why choose a Heated Towel Rail

Transform your bathroom with the comfort and luxury of warm, dry towels.



Warm dry towels

Gone is the experience of stepping out of a shower to a damp towel, now it's to a warm dry towel.



Energy efficient

Our range of rails are dry electric element which means they are extremely energy efficient. An average 600x800mm ladder rail will cost as little as 1c per hour to run. The dry element also ensures a rapid heat-up time of approx 10-20 minutes.



Quality Stainless Steel

Our rails are made from high-quality Stainless Steel designed for use in the bathroom and are backed by our warranties for your peace of mind.



Healthy drying

A Heated Towel Rail ensures your towel is kept dry, reducing the likelihood of germ and bacteria buildup.



Australian compliant

Our range of Heated Towel Rails are certified in accord with Australian standard AS/NZS 60335.1 and AS/NZS 60335.2.43.



Preserve your towels

A Heated Towel Rail will keep your towel drier, therefore reducing the number of times it needs to be washed. Further, drying your towels on a rail as opposed to a tumble dryer will extend your towels life span.

Types of Heated Towel Rails

The Thermorail range offers three different product types to suit your design and requirements.



Thermorad In-Wall Heater

Thermorad provides a revolutionary new way to dry your towels. The Thermorad panel is installed in your wall cavity directly behind where your towel rail will be installed. The panel creates an invisible towel dryer that reduces the drying time of your towels by up to 70% compared to a non-heated rail. The beauty of the Thermorad panel is that it can be used with any rail, robe hook or ladder without compromising on the design aesthetics of your room.



12Volt Low Voltage Heated Towel Rails

In a bathroom, there are electrical zones that influence where electrical items can be installed. In a wet area such as above a bath or in a shower and areas within 600mm of a tap, any electrical products need to be 12volts.

A 12V rail will still heat up in the same time, reach the same temperature and cost the same to run as a 240V rail, however, the low voltage makes it safe for use in wet areas. All Thermorail 12V rails are supplied with a transformer which reduces the incoming voltage from 240V down to 12V.



240Volt Heated Towel Rails

The 240V range of Heated Towel Rails are designed for use in bathrooms, outside of the wet areas as mentioned above. Being 240 Volts means that the rails can be hard-wired directly to existing power or plugged in for a retro-fit application.

The 240V range offers a variety of styles and designs, as well as several different colour finishes.

Available styles

Thermorail Heated Towel Rails transform your bathroom with the comfort and luxury of warm, dry towels.

When you are looking to add that little bit extra to your bathroom design, there is sure to be something that suits you from our extensive rail range.



Thermorad In-Wall Heater
Pages 76 - 79



12V Single Bar Range
Pages 81 - 85

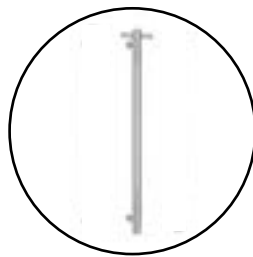

12V Vertical Bar Range
Pages 86 - 91



12V Ladder Range
Pages 92 - 93

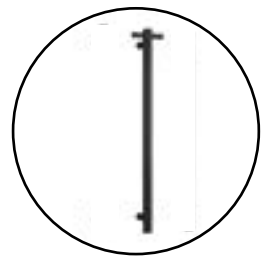

240V Vertical Bar Range
Page 95



Polished Stainless Steel Ladder Range
Pages 96 - 103

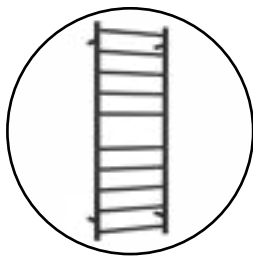

Matt Black Ladder Range
Pages 104 - 105



Brushed Stainless Steel Ladder Range
Pages 106 - 107



Coloured Ladder Range
Pages 108 - 109

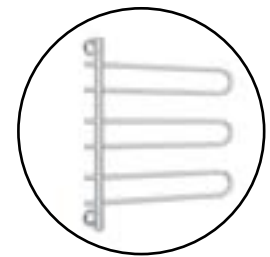

Swivel Ladder Range
Pages 110 - 111

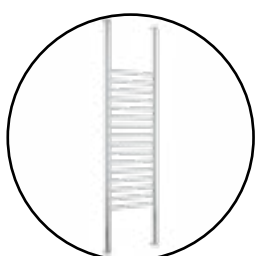

Floor-to-Ceiling Rail
Page 112



Free Standing Ladder Range
Page 113

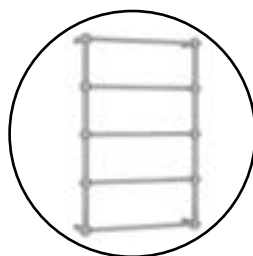

Heritage Ladder Rail
Page 114

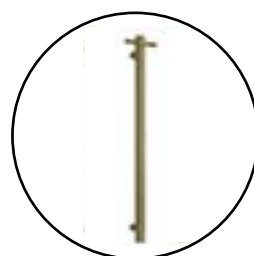

Custom Plated Range
Page 115



Non-Heated Range
Pages 118 - 119



↑ EDGE IS INSTALLED FLUSH WITH YOUR TIMBER SURFACE! ↑

↑ ATTENTION, ENSURE TRIM IS INSTALLED FLUSH WITH THE HEATING PANEL ↓



Thermorad TR5585

Thermorad In-Wall Heating Panel
Please refer to the installation instruction provided
240Vrms | 50Hz | 160Wrms

Thermogroup
1300 267 855
sales@thermogroup.com.au
www.thermogroup.com.au

thermorad
RADIANT WALL HEATING

Thermorad In-wall Heater

The perfect opportunity to make any towel rail a towel dryer by including a Thermorad In-Wall Heater



Create an invisible towel dryer

No one enjoys the experience of using a damp towel however it is a common reality for those who shower morning and evening or in areas of high humidity. The Thermorad sits invisibly in the wall and dries a damp towel in around 4-6 hours.



Reduce drying times by up to 70%

The Thermorad panel is designed to be concealed in the wall whilst radiating heat directly behind a towel rail, to reduce the drying time by up to 70% as opposed to a non-heated Towel Rail.

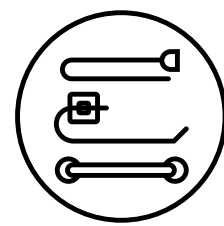

Suitable for use with any rail or robe hook

The beauty of the Thermorad is that it can be located behind any towel rail or robe hook no matter what the style, colour or finish. It can even be installed behind a non-heated ladder providing the fixing points are outside the panel area.



Low energy usage

The Thermorad draws 160 watts an hour, this means that if it was running for 6 hours a day it would cost around 25 cents a day to run.



Set and forget when used with a programmable timer

The use of a programmable timer allows you to set up your preferred drying schedule to ensure your towel is dry whenever you come to use it. Alternatively, it can be wired to a on/off switch for manual operation. Timers must be purchased separately.



Ten year guarantee

The Thermorad panel is backed by a 10 year warranty to give you peace of mind that your product will last for years to come.

Thermorad In-wall Heater

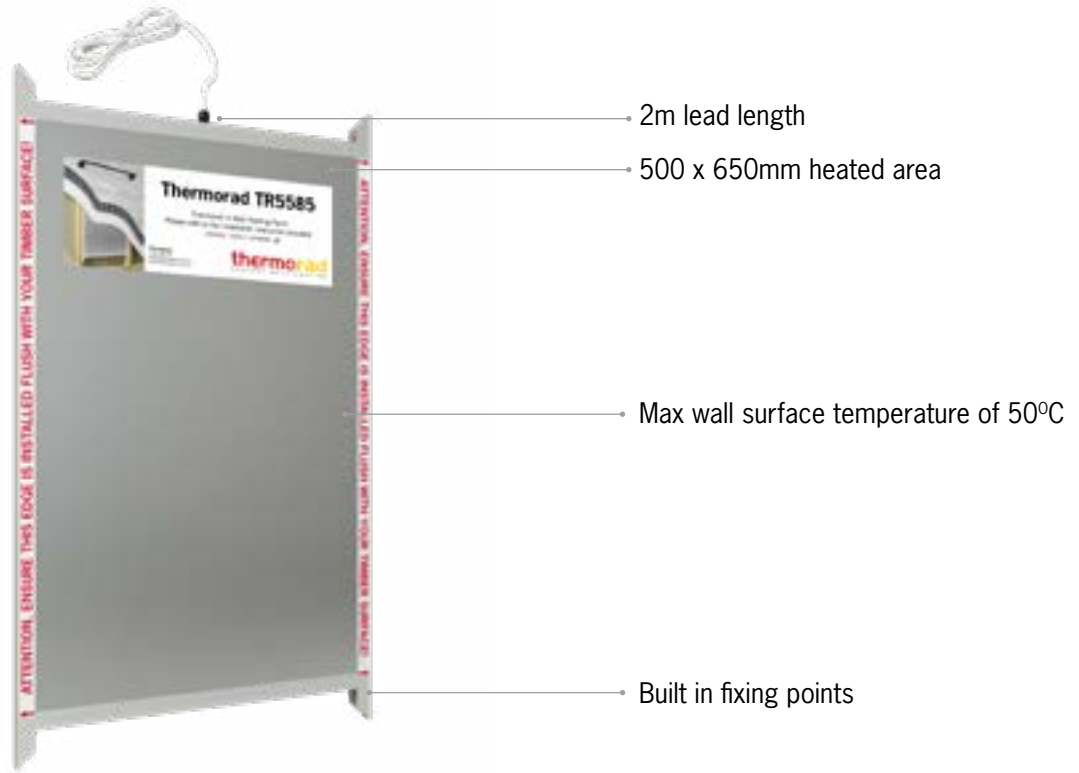

Stock Code	Size W x H x D (mm)	Output (W)	Voltage (V)	RRP \$ Incl.
TR5585	555 x 850 x 25*	160	240	\$459.00

*The overall size is 555x850mm with the heated area of 500x650mm.

Installation Overview

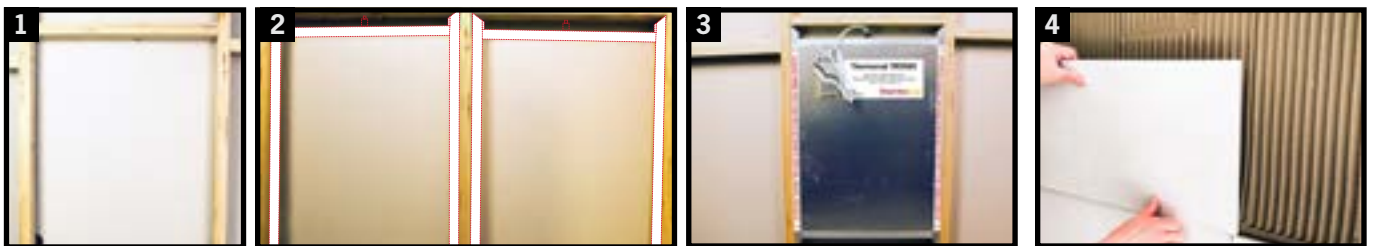

1 Modify frame work

The unit needs to sit between the studs in the wall with allowance for the power supply.

2 Double fixing requirements

For rails wider than 650mm we recommend installing two Thermorad panels next to each other.

3 Fix Thermorad in position

Fix the panel flush with the wall frame using the four fixing positions on the panel.

4 Sheet wall and tile

Complete the wall installation and mount your rail above the Thermorad.



This is an illustrative guide only. Read the instruction manual that is supplied with the panel in full before attempting installation.

thermorad
RADIANT WALL HEATING





Consider using a timer to control your Thermorad to ensure your towel is dry when you need it and to help control your running costs. See pages 116-117.



Thermorad FAQs

We have put together a range of answers to the most frequently asked questions about the Thermorad In-Wall Heaters. If you have a question that isn't answered here please give us a call or scan the QR Code to visit the Thermorad product page.

Does the Thermorad panel heat the room?

The Thermorad panel is primarily designed to dry your towels. It works on radiating heat from the wall surface, so the panel would help to take the chill out of the room however, this is not the primary purpose of the panel.

Will the heat affect my wall or tile glue?

No, the heat emitted from the panel is not hot enough to affect your tiles or tile glue, in the same way Underfloor Heating does not get hot enough to damage your floor.

What temperature does the wall get to?

The wall surface will get to around 30-35 degrees before a towel is placed on the rail. The towel helps to trap the heat and increases the temperature to around 40 degrees.

What is the heat-up time?

This will vary slightly depending on the thickness of your wall, however allow 45-60 minutes for the wall to heat up and 4-6 hours to dry your towel.

Will any of your timers work with Thermorad?

Yes, any of our rail timers will work with Thermorad. We recommend a timer so that the you can schedule the panel not to run the whole time. The Thermorad can even be used with the dual controller if you are also having Underfloor Heating in the room.

Does the Thermorad panel have an IP rating?

No, as it is installed in the wall cavity, it is not affected by the electrical zones, therefore, it does not require an IP rating. This means it can be installed in the wall above a bath or in the shower area.

Is there a particular spot in the wall the panel needs to be installed?

The panel needs to be installed flush with the front face of the stud wall so that there is no air pocket between the panel and the rear of the wall sheeting. The panel needs to be installed just below your towel rail, so the heat is radiating where your towel will be hanging.

Who installs Thermorad?

Anyone can install the panel itself. Follow the install instructions for mounting the panel. The wiring of the panel will need to be completed by an electrician.

Additional warranty details are found on pages 150-154.

thermorad
RADIANT WALL HEATING





Bathroom: AM Bathrooms & Projects
Image: Sebastian Photography
Model Shown: SR4412

12V Low Voltage Heated Towel Rails



Safe for use in wet areas

All the rails in this range are low voltage enabling them to be safely located anywhere in your bathroom or wet area providing you full flexibility with your bathroom design. See page 121 for electrical zoning.



Concealed dry element

All of the 12V ladder rails have a dry electric element that can be concealed wired on either the left or right-hand side of the rail while the vertical bars can be concealed wired at the top or bottom of the rail. Single Bar rails come as standard with right-hand side wiring, left-hand wiring is available upon request.

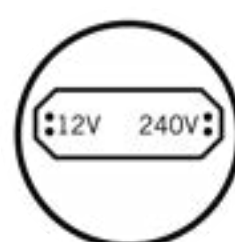

Transformer included

All of the Thermorail 12V range come with a 12V transformer meaning the only additional electrical item you require is a switch or timer to control the rail.



12V Single Bar Range

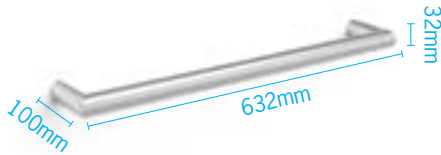

DSR6 Polished Stainless Steel

- Round Profile
- W632 x H32 x D100mm
- 18 Watt Output
- 10 Year Warranty

Stock Code	RRP \$ Incl.
DSR6	\$239.00

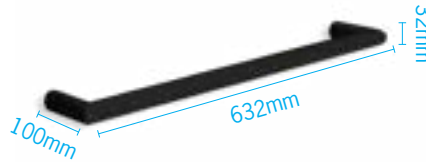

DSR6B Matt Black Coated

- Round Profile
- W632 x H32 x D100mm
- 18 Watt Output
- 7 Year Warranty

Stock Code	RRP \$ Incl.
DSR6B	\$269.00

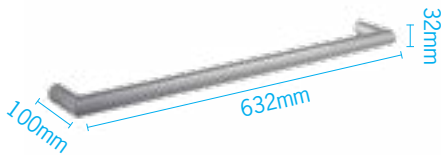

DSR6BR Brushed Stainless Steel

- Round Profile
- W632 x H32 x D100mm
- 18 Watt Output
- 7 Year Warranty

Stock Code	RRP \$ Incl.
DSR6BR	\$269.00

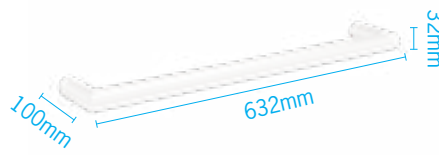

DSR6W Satin White Coated

- Round Profile
- W632 x H32 x D100mm
- 18 Watt Output
- 7 Year Warranty

Stock Code	RRP \$ Incl.
DSR6W	\$269.00

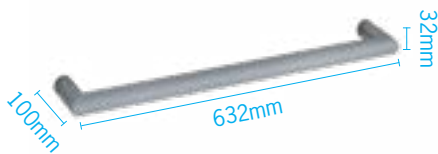

DSR6GM Gun Metal PVD

- Round Profile
- W632 x H32 x D100mm
- 18 Watt Output
- 7 Year Warranty

Stock Code	RRP \$ Incl.
DSR6GM	\$358.00



DSR6BG Brushed Gold PVD

- Round Profile
- W632 x H32 x D100mm
- 18 Watt Output
- 7 Year Warranty

Stock Code	RRP \$ Incl.
DSR6BG	\$358.00



Transformer included
(12 month warranty)



Low voltage, safe for use in bathrooms



Quality Stainless Steel



Coloured Stainless Steel



Right hand concealed wiring



Recommended to be installed in a set of 3+

12V Single Bar Range

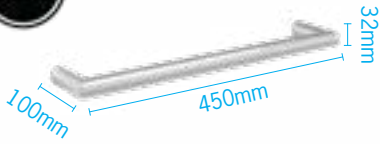

DSR4 Polished Stainless Steel

- Round Profile
- W450 x H32 x D100mm
- 14 Watt Output
- 10 Year Warranty

Stock Code	RRP \$ Incl.
DSR4	\$216.00

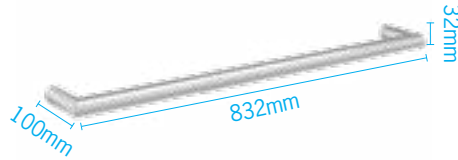

DSR8 Polished Stainless Steel

- Round Profile
- W832 x H32 x D100mm
- 23 Watt Output
- 10 Year Warranty

Stock Code	RRP \$ Incl.
DSR8	\$299.00



Transformer included
(12 month warranty)



Low voltage, safe for use in bathrooms



Quality Stainless Steel



Coloured Stainless Steel



Right hand concealed wiring



Recommended to be installed in a set of 3+

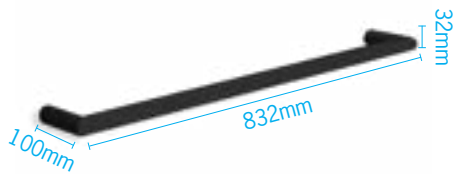

DSR8B Matt Black Coated

- Round Profile
- W832 x H32 x D100mm
- 23 Watt Output
- 7 Year Warranty

Stock Code	RRP \$ Incl.
DSR8B	\$325.00

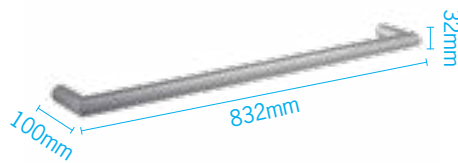

DSR8BR Brushed Stainless Steel

- Round Profile
- W832 x H32 x D100mm
- 23 Watt Output
- 7 Year Warranty

Stock Code	RRP \$ Incl.
DSR8BR	\$325.00

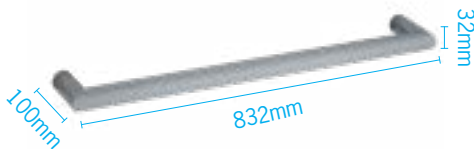

DSR8GM Gun Metal PVD

- Round Profile
- W832 x H32 x D100mm
- 23 Watt Output
- 7 Year Warranty

Stock Code	RRP \$ Incl.
DSR8GM	\$425.00



DSR8BG Brushed Gold PVD

- Round Profile
- W832 x H32 x D100mm
- 23 Watt Output
- 7 Year Warranty

Stock Code	RRP \$ Incl.
DSR8BG	\$425.00

12V Single Bar Range

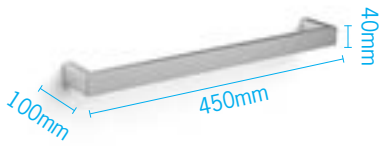

DSS4 Polished Stainless Steel

- ☛ Square Profile
- ☛ W450 x H40 x D100mm
- ☛ 17 Watt Output
- ☛ 10 Year Warranty

Stock Code	RRP \$ Incl.
DSS4	\$216.00

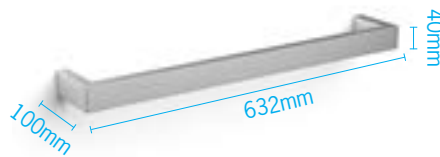

DSS6 Polished Stainless Steel

- ☛ Square Profile
- ☛ W632 x H40 x D100mm
- ☛ 23 Watt Output
- ☛ 10 Year Warranty

Stock Code	RRP \$ Incl.
DSS6	\$239.00

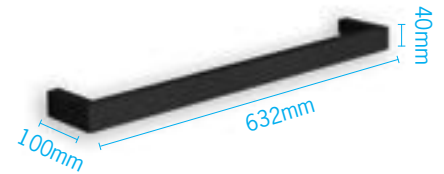

DSS6B Matt Black Coated

- ☛ Square Profile
- ☛ W632 x H40 x D100mm
- ☛ 23 Watt Output
- ☛ 7 Year Warranty

Stock Code	RRP \$ Incl.
DSS6B	\$269.00

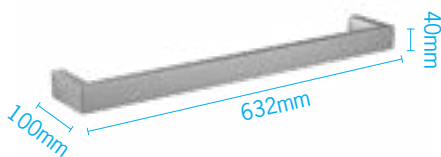

DSS6BR Brushed Stainless Steel

- ☛ Square Profile
- ☛ W632 x H40 x D100mm
- ☛ 23 Watt Output
- ☛ 7 Year Warranty

Stock Code	RRP \$ Incl.
DSS6BR	\$269.00

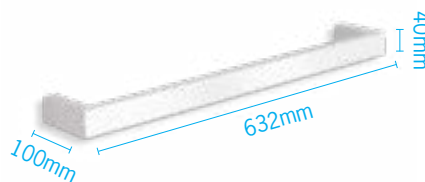

DSS6W Satin White Coated

- ☛ Square Profile
- ☛ W632 x H40 x D100mm
- ☛ 23 Watt Output
- ☛ 7 Year Warranty

Stock Code	RRP \$ Incl.
DSS6W	\$269.00

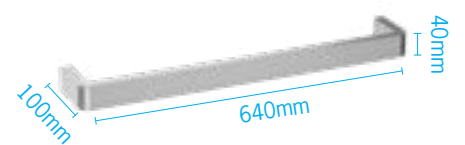

DSC6 Polished Stainless Steel

- ☛ Square Profile with rounded corners
- ☛ W640 x H40 x D100mm
- ☛ 23 Watt Output
- ☛ 10 Year Warranty

Stock Code	RRP \$ Incl.
DSC6	\$239.00

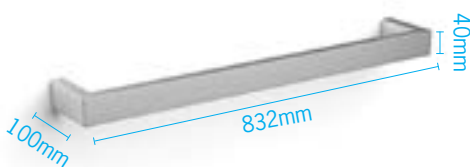

DSS8 Polished Stainless Steel

- ☛ Square Profile
- ☛ W832 x H40 x D100mm
- ☛ 30 Watt Output
- ☛ 10 Year Warranty

Stock Code	RRP \$ Incl.
DSS8	\$299.00

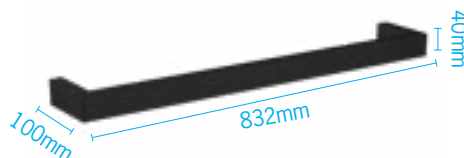

DSS8B Matt Black Coated

- ☛ Square Profile
- ☛ W832 x H40 x D100mm
- ☛ 30 Watt Output
- ☛ 7 Year Warranty

Stock Code	RRP \$ Incl.
DSS8B	\$319.00

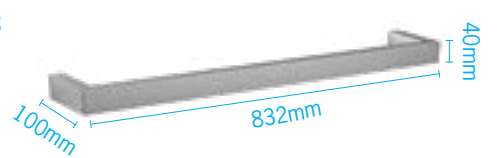

DSS8BR Brushed Stainless Steel

- ☛ Square Profile
- ☛ W832 x H40 x D100mm
- ☛ 30 Watt Output
- ☛ 7 Year Warranty

Stock Code	RRP \$ Incl.
DSS8BR	\$319.00

Round and Square Single Bar Mounting System

The mounting system allows easy installation of multiple single bar rails by ensuring perfect rail spacing and allowing for the supply cable to be installed before the wall is sheeted. Mounting spigots are supplied with the single bar towel rails when purchased with a mounting kit.

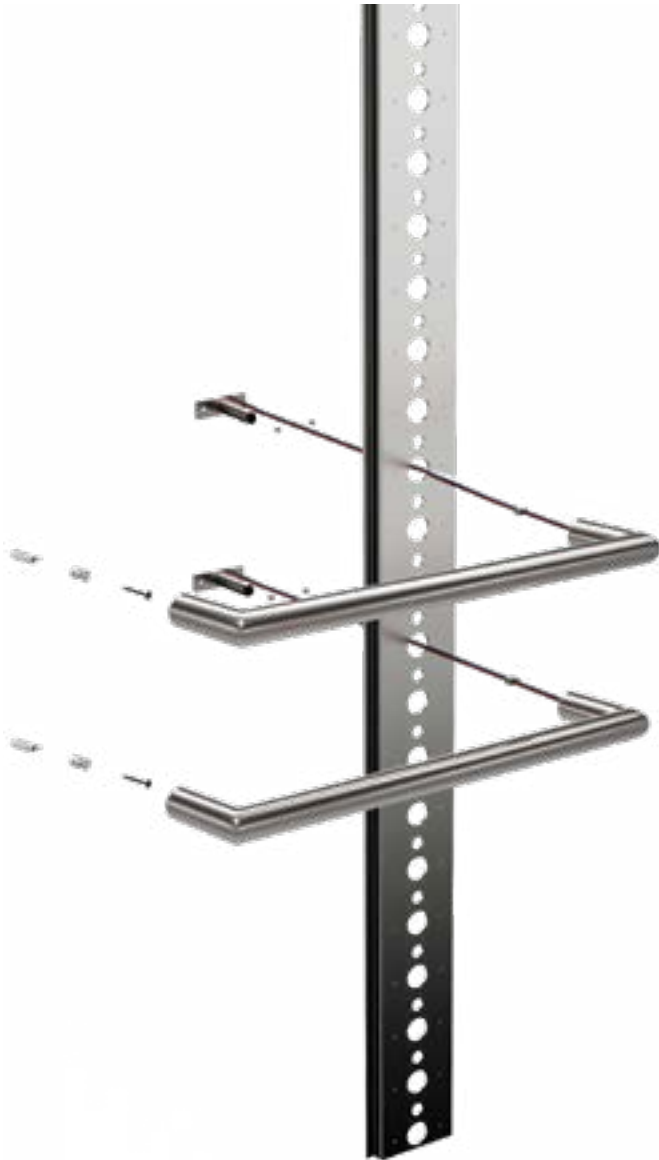

Stock Code	Description	Size (mm)	RRP \$ incl.
7060	Thermorail Mounting System	H1000 x W110 x D10	\$205.00
7062	Thermorail Spigot for 7060 Mounting System		Supplied free with 7060

Not suitable for use with vertical, ladder rails or the pill profile horizontal rails (DSP codes). The 7060 mounting kit only needs to be installed on the right hand side of the rails. The mounting system can fit up to 7 rails at 150mm spacing. The 7062 spigots are supplied free of charge, equivalent to the number of rails purchased.





Model Shown: DSP6B

12V Single Bar Range



Transformer included
(12 month warranty)



Right hand concealed wiring



Quality Stainless Steel



Coloured Stainless Steel



Low voltage, safe for use in bathrooms



Recommended to be installed in a set of 3+

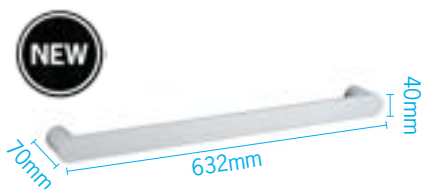

DSP6 Polished Stainless Steel

- Pill Profile
- W632 x H40 x D70mm
- 13 Watt Output
- 10 Year Warranty

Stock Code	RRP \$ Incl.
DSP6	\$359.00



DSP6B Matt Black Coated

- Pill Profile
- W632 x H40 x D70mm
- 13 Watt Output
- 7 Year Warranty

Stock Code	RRP \$ Incl.
DSP6B	\$389.00

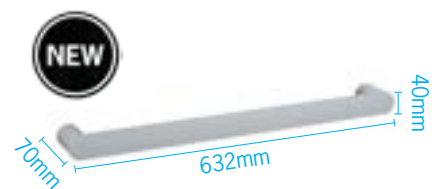

DSP6BR Brushed Stainless Steel

- Pill Profile
- W632 x H40 x D70mm
- 13 Watt Output
- 7 Year Warranty

Stock Code	RRP \$ Incl.
DSP6BR	\$389.00



Model Shown: VS900HBG

12V Vertical Bar Range

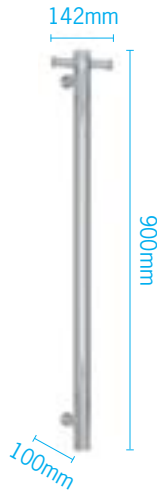

VS900H Polished Stainless Steel

- Round Profile
- W142 x H900 x D100mm
- 30 Watt Output
- 10 Year Warranty
- Removable Hook

Stock Code	RRP \$ Incl.
VS900H	\$369.00



VS900HB Matt Black Coated

- Round Profile
- W142 x H900 x D100mm
- 30 Watt Output
- 7 Year Warranty
- Removable Hook

Stock Code	RRP \$ Incl.
VS900HB	\$409.00

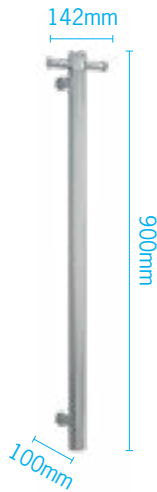

VS900HBR Brushed Stainless Steel

- Round Profile
- W142 x H900 x D100mm
- 30 Watt Output
- 7 Year Warranty
- Removable Hook

Stock Code	RRP \$ Incl.
VS900HBR	\$409.00



VS900HBN Brushed Nickel PVD

- Round Profile
- W142 x H900 x D100mm
- 30 Watt Output
- 7 Year Warranty
- Removable Hook

Stock Code	RRP \$ Incl.
VS900HBN	\$459.00



Transformer included
(12 month warranty)



Low voltage, safe for use in bathrooms



Quality Stainless Steel



Concealed wiring only



One towel per bar recommended



Vertical bar size

For the 240Volt Range of vertical rails see page 95

12V Vertical Bar Range

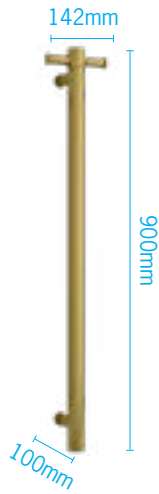

VS900HBG Brushed Gold PVD

- Round Profile
- W142 x H900 x D100mm
- 30 Watt Output
- 7 Year Warranty
- Removable Hook

Stock Code	RRP \$ Incl.
VS900HBG	\$459.00

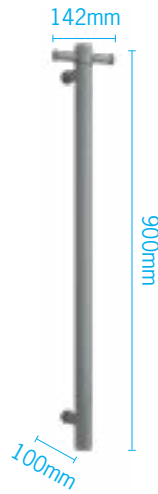

VS900HGM Gun Metal PVD

- Round Profile
- W142 x H900 x D100mm
- 30 Watt Output
- 7 Year Warranty
- Removable Hook

Stock Code	RRP \$ Incl.
VS900HGM	\$529.00

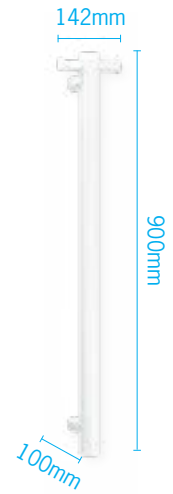

VS900HSW Satin White Coated

- Round Profile
- W142 x H900 x D100mm
- 30 Watt Output
- 7 Year Warranty
- Removable Hook

Stock Code	RRP \$ Incl.
VS900HSW	\$459.00

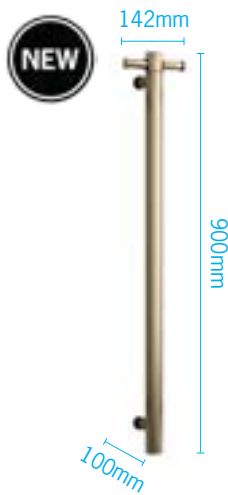

VS900HBB Brushed Brass PVD

- Round Profile
- W142 x H900 x D100mm
- 30 Watt Output
- 7 Year Warranty
- Removable Hook

Stock Code	RRP \$ Incl.
VS900HBB	\$459.00

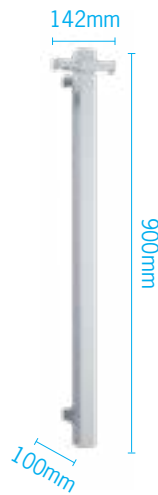

VS900SH Polished Stainless Steel

- Square Profile 40x40mm
- W142 x H900 x D100mm
- 30 Watt Output
- 10 Year Warranty
- Removable Hook

Stock Code	RRP \$ Incl.
VS900SH	\$410.00



VS900SHB Matt Black Coated

- Square Profile 35x35mm
- W142 x H900 x D100mm
- 27 Watt Output
- 7 Year Warranty
- Removable Hook

Stock Code	RRP \$ Incl.
VS900SHB	\$451.00

VS900HBB is now a stocked item.
The finish has changed slightly from the plated range model.



Model Shown: VS900HDP



Transformer included
(12 month warranty)



Low voltage, safe for use in bathrooms



Concealed wiring only



Quality Stainless Steel



One towel per bar recommended



Vertical bar size

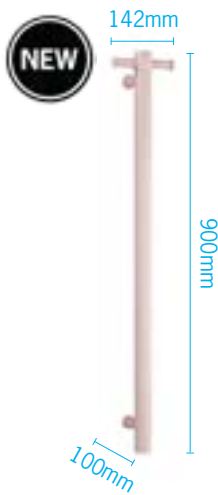

VS900HDP Pastel Dusty Pink

- ✔ Round Profile
- ✔ W142 x H900 x D100mm
- ✔ 30 Watt Output
- ✔ 7 Year Warranty
- ✔ Removable Hook

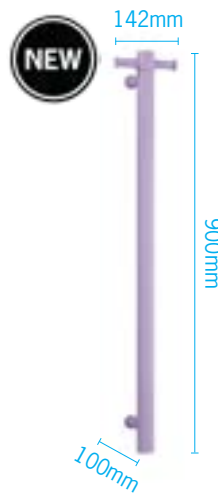

VS900HLS Pastel Lilac Satin

- ✔ Round Profile
- ✔ W142 x H900 x D100mm
- ✔ 30 Watt Output
- ✔ 7 Year Warranty
- ✔ Removable Hook

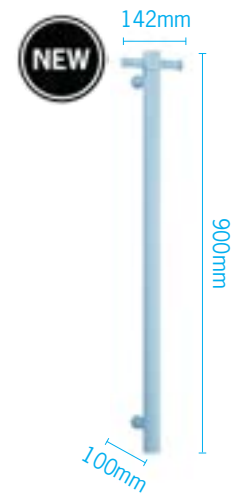

VS900HBL Pastel Horizon Blue

- ✔ Round Profile
- ✔ W142 x H900 x D100mm
- ✔ 30 Watt Output
- ✔ 7 Year Warranty
- ✔ Removable Hook

Stock Code	RRP \$ Incl.
VS900HDP	\$599.00

Stock Code	RRP \$ Incl.
VS900HLS	\$599.00

Stock Code	RRP \$ Incl.
VS900HBL	\$599.00

For the 240Volt Range of vertical rails see page 95



Model Shown: VP900BR

12V Vertical Bar Range

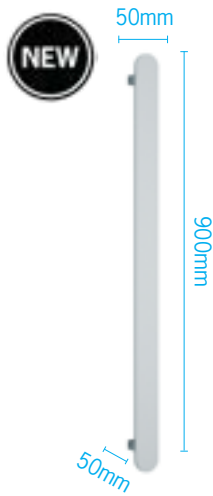

VP900 Polished Stainless Steel

- Pill shape, flat profile
- W50 x H900 x D50mm
- 20 Watt Output
- 10 Year Warranty

Stock Code	RRP \$ Incl.
VP900	\$499.00

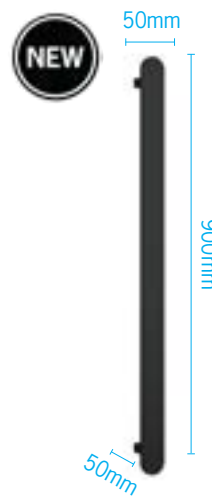

VP900B Matt Black Coated

- Pill shape, flat profile
- W50 x H900 x D50mm
- 25 Watt Output
- 7 Year Warranty

Stock Code	RRP \$ Incl.
VP900B	\$539.00



VP900BR Brushed Stainless Steel

- Pill shape, flat profile
- W50 x H900 x D50mm
- 20 Watt Output
- 7 Year Warranty

Stock Code	RRP \$ Incl.
VP900BR	\$539.00



Transformer included
(12 month warranty)



Low voltage, safe for use in bathrooms



Quality Stainless Steel



Concealed wiring only

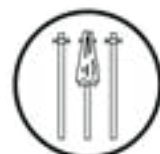

One towel per bar recommended



Flat bar size



Model Shown: SR4412

12V Ladder Range



SR2512 Polished Stainless Steel

- Round Profile
- W550 x H550 x D122mm
- 4 Bars
- 65 Watt Output
- 10 Year Warranty

Stock Code	RRP \$ Incl.
SR2512	\$589.00



SR2512B Matt Black Coated

- Round Profile
- W550 x H550 x D122mm
- 4 Bars
- 70 Watt Output
- 7 Year Warranty

Stock Code	RRP \$ Incl.
SR2512B	\$679.00

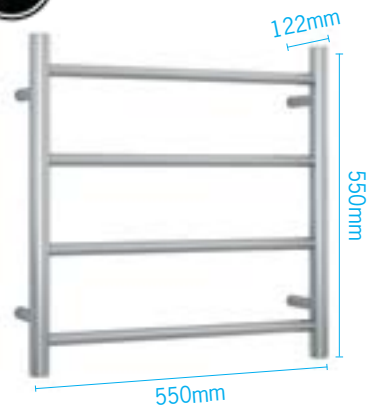

SRB2512 Brushed Stainless Steel

- Round Profile
- W550 x H550 x D122mm
- 4 Bars
- 65 Watt Output
- 7 Year Warranty

Stock Code	RRP \$ Incl.
SRB2512	\$649.00

12V Ladder Range



SR4412 Polished Stainless Steel

- Round Profile
- W600 x H800 x D122mm
- 7 Bars
- 90 Watt Output
- 10 Year Warranty

Stock Code	RRP \$ Incl.
SR4412	\$629.00



SR4412B Matt Black Coated

- Round Profile
- W600 x H800 x D122mm
- 7 Bars
- 100 Watt Output
- 7 Year Warranty

Stock Code	RRP \$ Incl.
SR4412B	\$755.00



Transformer included
(12 month warranty)



Low voltage, safe for use in bathrooms



Quality Stainless Steel



SRB4412 Brushed Stainless Steel

- Round Profile
- W600 x H800 x D122mm
- 7 Bars
- 90 Watt Output
- 7 Year Warranty

Stock Code	RRP \$ Incl.
SRB4412	\$715.00



SS4412 Polished Stainless Steel

- Square Profile
- W600 x H800 x D120mm
- 7 Bars
- 90 Watt Output
- 10 Year Warranty

Stock Code	RRP \$ Incl.
SS4412	\$745.00



Concealed wiring all legs

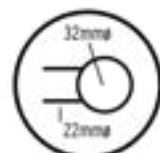

Round vertical and horizontal bar sizes

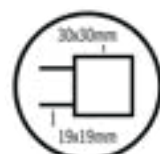

Square vertical and horizontal bar sizes



Model Shown: SR44MBN

240Volt Heated Towel Rails



Multiflex wiring

Multiflex wiring provides a range of wiring options within one rail so the wiring location can be decided at the time of installation. The wiring options are either the top or bottom on either the left or right-hand side. For more details refer to page 120.



Concealed or exposed wiring

Multiflex wiring also offers the option of either concealed (hard-wired) or exposed (plug-in) options to accommodate your requirements.



Safe for use in bathrooms

The 240V units are safe for use in bathrooms outside of the wet area of a shower or bath. All Thermorail Heated Towels Rails are certified at or above the minimum IP safety level. For more details refer to page 121.

Model Shown: VSH900HB



Safe for use
in bathrooms



Concealed
wiring only



Quality
Stainless Steel



One towel
per bar
recommended



Vertical bar
size



240Volt Vertical Bar Range

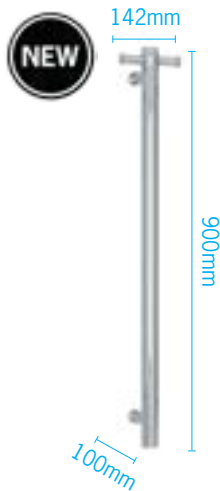

VSH900H Polished Stainless Steel

- Round Profile
- W142 x H900 x D100mm
- 20 Watt Output
- 10 Year Warranty
- Removable Hook



VSH900HB Matt Black Coated

- Round Profile
- W142 x H900 x D100mm
- 24 Watt Output
- 7 Year Warranty
- Removable Hook

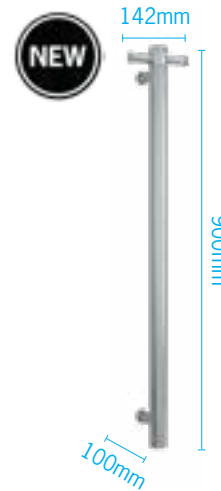

VSH900HBR Brushed Stainless Steel

- Round Profile
- W142 x H900 x D100mm
- 20 Watt Output
- 7 Year Warranty
- Removable Hook

Stock Code	RRP \$ Incl.
VSH900H	\$319.00

Stock Code	RRP \$ Incl.
VSH900HB	\$359.00

Stock Code	RRP \$ Incl.
VSH900HBR	\$359.00

For the 12Volt Range of vertical rails see pages 86-91



Model Shown: SR44M



Ten year warranty



Safe for use in bathrooms



Multiflex wiring on all legs



Quality Stainless Steel



Hard-wired or plug-in



Vertical and horizontal bar size

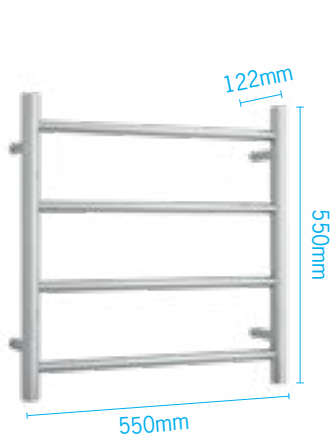

SR25M

- Polished Stainless Steel
- Straight Round Profile
- W550 x H550 x D122mm
- 4 Bars
- 41 Watt Output



SR17M

- Polished Stainless Steel
- Straight Round Profile
- W400 x H1120 x D122mm
- 8 Bars
- 65 Watt Output



SR23M

- Polished Stainless Steel
- Straight Round Profile
- W530 x H700 x D122mm
- 8 Bars
- 76 Watt Output

Stock Code	RRP \$ Incl.
SR25M	\$432.00

Stock Code	RRP \$ Incl.
SR17M	\$595.00

Stock Code	RRP \$ Incl.
SR23M	\$539.00

240Volt Straight Round Range



SR44M

- Polished Stainless Steel
- Straight Round Profile
- W600 x H800 x D122mm
- 7 Bars
- 80 Watt Output

Stock Code	RRP \$ Incl.
SR44M	\$499.00

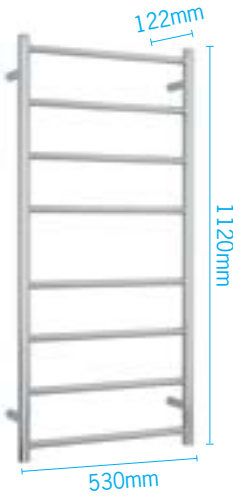

SR27M

- Polished Stainless Steel
- Straight Round Profile
- W530 x H1120 x D122mm
- 8 Bars
- 80 Watt Output

Stock Code	RRP \$ Incl.
SR27M	\$699.00

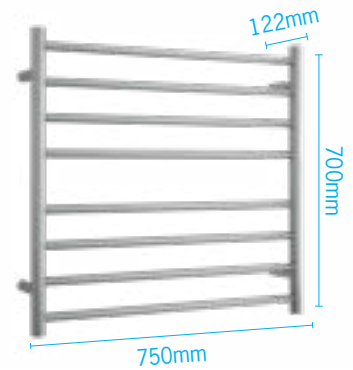

SR33M

- Polished Stainless Steel
- Straight Round Profile
- W750 x H700 x D122mm
- 8 Bars
- 104 Watt Output

Stock Code	RRP \$ Incl.
SR33M	\$585.00

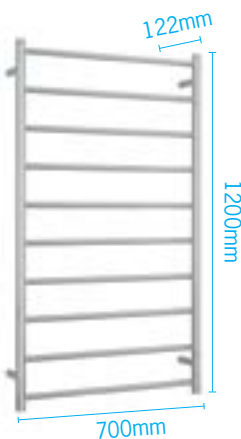

SR69M

- Polished Stainless Steel
- Straight Round Profile
- W700 x H1200 x D122mm
- 10 Bars
- 128 Watt Output

Stock Code	RRP \$ Incl.
SR69M	\$759.00

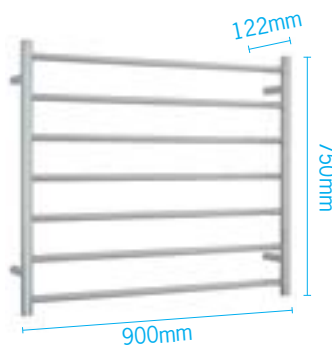

SR93M

- Polished Stainless Steel
- Straight Round Profile
- W900 x H750 x D122mm
- 7 Bars
- 100 Watt Output

Stock Code	RRP \$ Incl.
SR93M	\$809.00

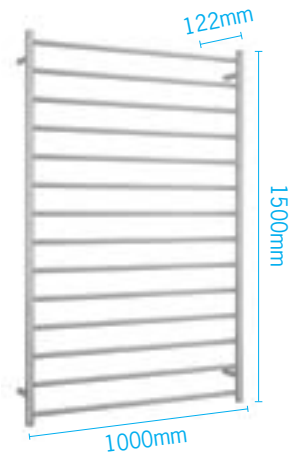

SR99M

- Polished Stainless Steel
- Straight Round Profile
- W1000 x H1500 x D122mm
- 14 Bars
- 244 Watt Output

Stock Code	RRP \$ Incl.
SR99M	\$1,239.00

Heated Towel Rails



Model Shown: CR23M



Ten year warranty



Safe for use in bathrooms



Multiflex wiring on all legs



Quality Stainless Steel



Hard-wired or plug-in



Vertical and horizontal bar size

240Volt Curved Round Range

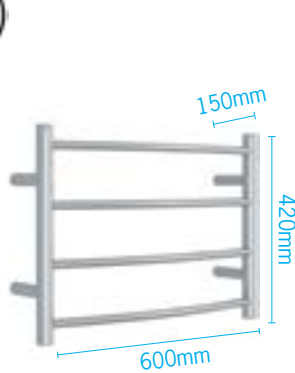

CR40M

- Polished Stainless Steel
- Curved Round Profile
- W600 x H420 x D150mm
- 4 Bars
- 45 Watt Output

Stock Code	RRP \$ Incl.
CR40M	\$539.00



CR23M

- Polished Stainless Steel
- Curved Round Profile
- W530 x H700 x D150mm
- 8 Bars
- 78 Watt Output

Stock Code	RRP \$ Incl.
CR23M	\$619.00



CR44M

- Polished Stainless Steel
- Curved Round Profile
- W600 x H800 x D150mm
- 7 Bars
- 80 Watt Output

Stock Code	RRP \$ Incl.
CR44M	\$669.00

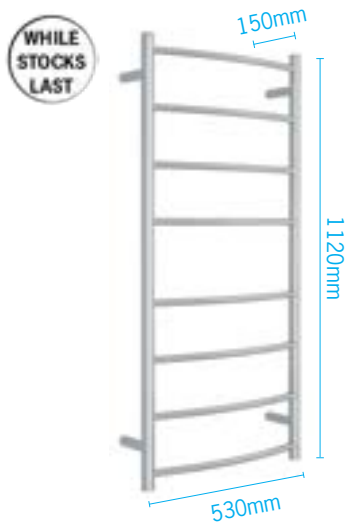

CR27M

- Polished Stainless Steel
- Curved Round Profile
- W530 x H1120 x D150mm
- 8 Bars
- 82 Watt Output

Stock Code	RRP \$ Incl.
CR27M	\$729.00

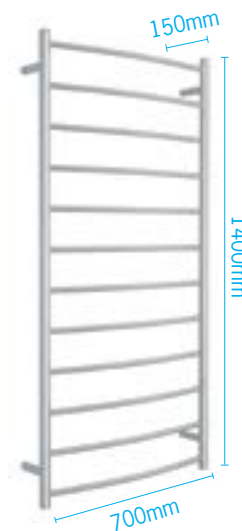

CR69M

- Polished Stainless Steel
- Curved Round Profile
- W700 x H1400 x D150mm
- 12 Bars
- 153 Watt Output

Stock Code	RRP \$ Incl.
CR69M	\$999.00



Model Shown: SS88M



Ten year warranty



Safe for use in bathrooms



Multiflex wiring on all legs



Quality Stainless Steel



Hard-wired or plug-in

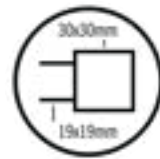

Vertical and horizontal bar size

240Volt Straight Square Range

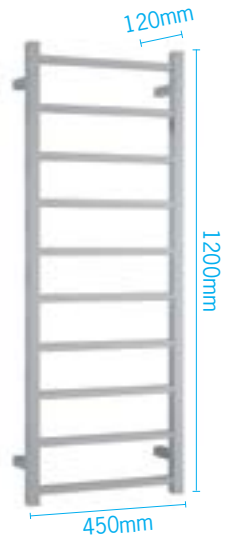
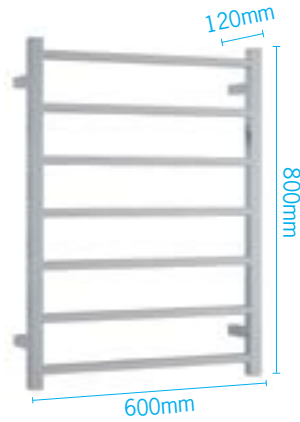

SS40M

- Polished Stainless Steel
- Straight Square Profile
- W600 x H420 x D120mm
- 4 Bars
- 47 Watt Output

SS44M

- Polished Stainless Steel
- Straight Square Profile
- W600 x H800 x D120mm
- 7 Bars
- 83 Watt Output

SS19M

- Polished Stainless Steel
- Straight Square Profile
- W450 x H1200 x D120mm
- 10 Bars
- 89 Watt Output

Stock Code	RRP \$ Incl.
SS40M	\$499.00

Stock Code	RRP \$ Incl.
SS44M	\$615.00

Stock Code	RRP \$ Incl.
SS19M	\$715.00

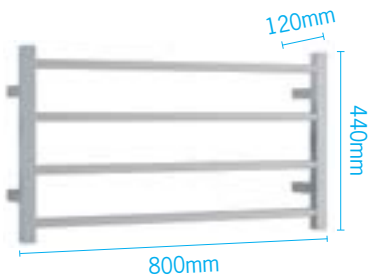

SS81M

- Polished Stainless Steel
- Straight Square Profile
- W800 x H440 x D120mm
- 4 Bars
- 61 Watt Output

SS88M

- Polished Stainless Steel
- Straight Square Profile
- W800 x H1160 x D120mm
- 10 Bars
- 153 Watt Output

Stock Code	RRP \$ Incl.
SS81M	\$639.00

Stock Code	RRP \$ Incl.
SS88M	\$869.00



Model Shown: BS24M



Seven year warranty



Safe for use in bathrooms



Multiflex wiring on all legs



Quality Stainless Steel



Hard-wired or plug-in



Round vertical and horizontal bar sizes

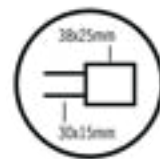

Square vertical and horizontal bar sizes

240Volt Budget Range

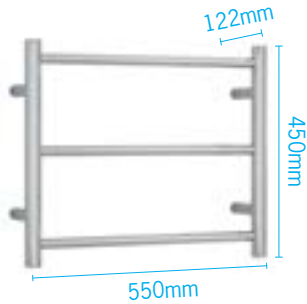

BS24M

- Polished Stainless Steel
- Straight Round Profile
- W550 x H450 x D122mm
- 3 Bars
- 33 Watt Output

Stock Code	RRP \$ Incl.
BS24M	\$325.00



BC44M

- Polished Stainless Steel
- Curved Round Profile
- W600 x H800 x D150mm
- 7 Bars
- 80 Watt Output

Stock Code	RRP \$ Incl.
BC44M	\$499.00



BS44M

- Polished Stainless Steel
- Straight Round Profile
- W600 x H800 x D122mm
- 7 Bars
- 80 Watt Output

Stock Code	RRP \$ Incl.
BS44M	\$449.00

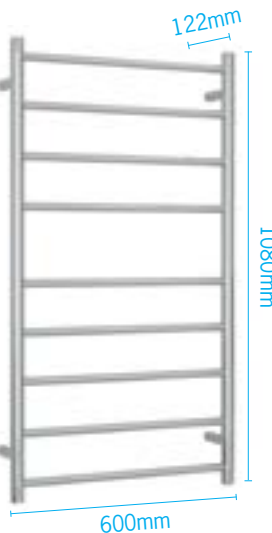

BS46M

- Polished Stainless Steel
- Straight Round Profile
- W600 x H1080 x D122mm
- 9 Bars
- 103 Watt Output

Stock Code	RRP \$ Incl.
BS46M	\$539.00

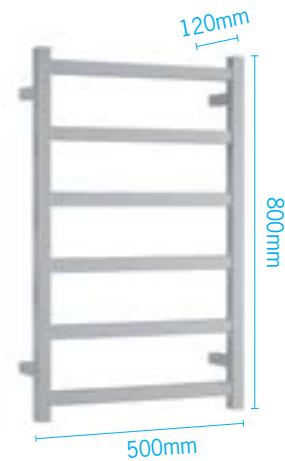

BS28M

- Polished Stainless Steel
- Straight Square Profile
- W500 x H800 x D120mm
- 6 Bars
- 81 Watt Output

Stock Code	RRP \$ Incl.
BS28M	\$475.00



Model Shown: SR69MB

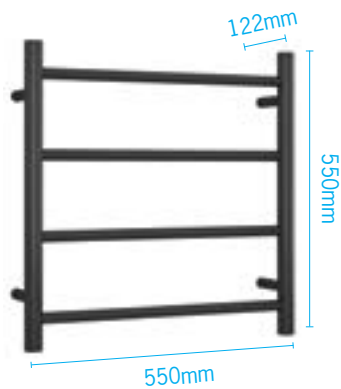

SR25MB

- Matt Black Powder Coated
- Straight Round Profile
- W550 x H550 x D122mm
- 4 Bars
- 54 Watt Output

Stock Code	RRP \$ Incl.
SR25MB	\$519.00

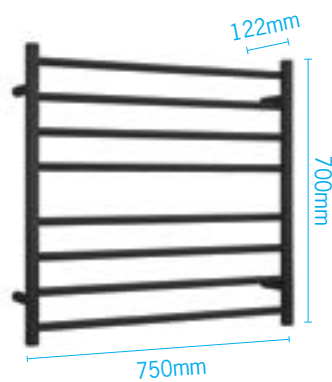

SR33MB

- Matt Black Powder Coated
- Straight Round Profile
- W750 x H700 x D122mm
- 8 Bars
- 132 Watt Output

Stock Code	RRP \$ Incl.
SR33MB	\$799.00



SR44MB

- Matt Black Powder Coated
- Straight Round Profile
- W600 x H800 x D122mm
- 7 Bars
- 100 Watt Output

Stock Code	RRP \$ Incl.
SR44MB	\$645.00

240Volt Black Range

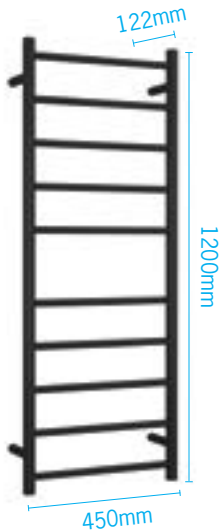

SR19MB

- Matt Black Powder Coated
- Straight Round Profile
- W450 x H1200 x D122mm
- 10 Bars
- 110 Watt Output

Stock Code	RRP \$ Incl.
SR19MB	\$770.00

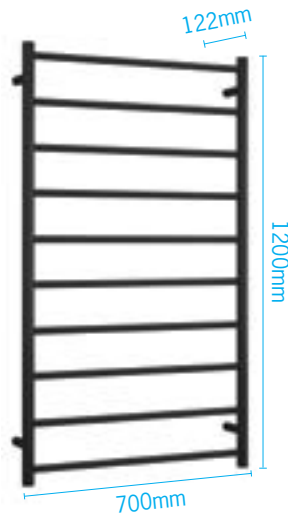

SR69MB

- Matt Black Powder Coated
- Straight Round Profile
- W700 x H1200 x D122mm
- 10 Bars
- 162 Watt Output

Stock Code	RRP \$ Incl.
SR69MB	\$999.00

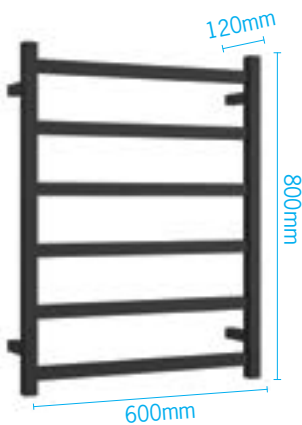

BS48MB

- Matt Black Powder Coated
- Straight Square Profile
- W600 x H800 x D120mm
- 6 Bars
- 104 Watt Output

Stock Code	RRP \$ Incl.
BS48MB	\$695.00

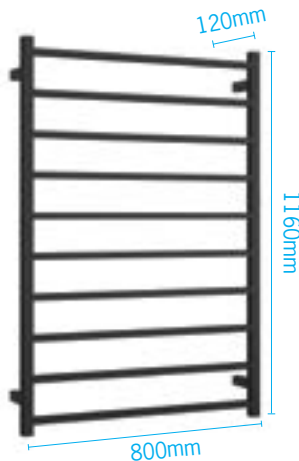

SS88MB

- Matt Black Powder Coated
- Straight Square Profile
- W800 x H1160 x D120mm
- 10 Bars
- 217 Watt Output

Stock Code	RRP \$ Incl.
SS88MB	\$1,059.00



Seven year warranty



Safe for use in bathrooms



Multiflex wiring on all legs



Quality Stainless Steel



Hard-wired or plug-in



Round vertical and horizontal bar sizes

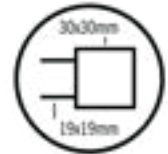

Square vertical and horizontal bar sizes



Model Shown: SRB27M



Seven year warranty



Safe for use in bathrooms



Multiflex wiring on all legs



Quality Stainless Steel



Hard-wired or plug-in



Round vertical and horizontal bar sizes

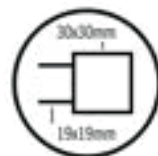

Square vertical and horizontal bar sizes

240Volt Brushed Stainless Steel Range



SRB25M

- Brushed Stainless Steel
- Straight Round Profile
- W550 x H550 x D122mm
- 4 Bars
- 41 Watt Output

Stock Code	RRP \$ Incl.
SRB25M	\$489.00



SRB44M

- Brushed Stainless Steel
- Straight Round Profile
- W600 x H800 x D122mm
- 7 Bars
- 80 Watt Output

Stock Code	RRP \$ Incl.
SRB44M	\$569.00

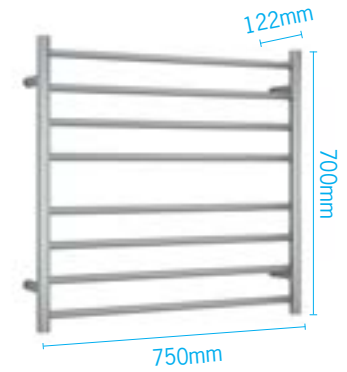

SRB33M

- Brushed Stainless Steel
- Straight Round Profile
- W750 x H700 x D122mm
- 8 Bars
- 104 Watt Output

Stock Code	RRP \$ Incl.
SRB33M	\$675.00



SRB27M

- Brushed Stainless Steel
- Straight Round Profile
- W530 x H1120 x D122mm
- 8 Bars
- 80 Watt Output

Stock Code	RRP \$ Incl.
SRB27M	\$749.00

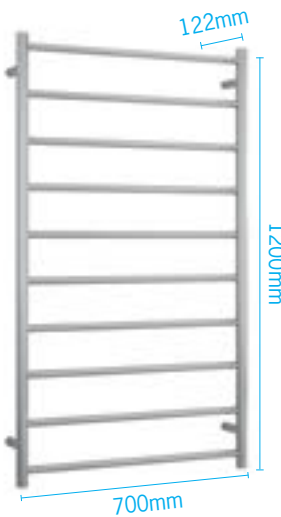

SRB69M

- Brushed Stainless Steel
- Straight Round Profile
- W700 x H1200 x D122mm
- 10 Bars
- 128 Watt Output

Stock Code	RRP \$ Incl.
SRB69M	\$849.00



SSB44M

- Brushed Stainless Steel
- Straight Square Profile
- W600 x H800 x D120mm
- 7 Bars
- 83 Watt Output

Stock Code	RRP \$ Incl.
SSB44M	\$669.00

240Volt Coloured Range



SR25MGM Gun Metal PVD

- Gun Metal PVD Plated
- Straight Round Profile
- W550 x H550 x D122mm
- 4 Bars
- 41 Watt Output

Stock Code	RRP \$ Incl.
SR25MGM	\$849.00

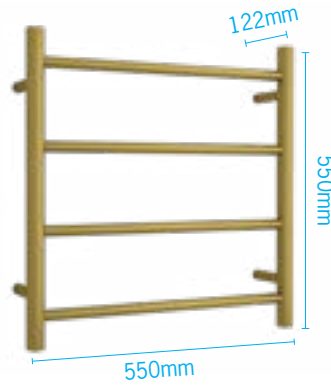

SR25MBG Brushed Gold PVD

- Brushed Gold PVD Plated
- Straight Round Profile
- W550 x H550 x D122mm
- 4 Bars
- 41 Watt Output

Stock Code	RRP \$ Incl.
SR25MBG	\$719.00

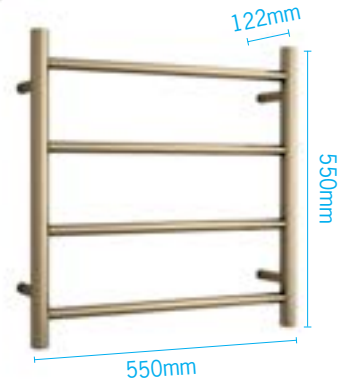

SR25MBB Brushed Brass PVD

- Brushed Brass PVD Plated
- Straight Round Profile
- W550 x H550 x D122mm
- 4 Bars
- 41 Watt Output

Stock Code	RRP \$ Incl.
SR25MBB	\$719.00



SR44MGM Gun Metal PVD

- Gun Metal PVD Plated
- Straight Round Profile
- W600 x H800 x D122mm
- 7 Bars
- 80 Watt Output

Stock Code	RRP \$ Incl.
SR44MGM	\$1,259.00



SR44MBG Brushed Gold PVD

- Brushed Gold PVD Plated
- Straight Round Profile
- W600 x H800 x D122mm
- 7 Bars
- 80 Watt Output

Stock Code	RRP \$ Incl.
SR44MBG	\$955.00



SR44MBB Brushed Brass PVD

- Brushed Brass PVD Plated
- Straight Round Profile
- W600 x H800 x D122mm
- 7 Bars
- 80 Watt Output

Stock Code	RRP \$ Incl.
SR44MBB	\$955.00

240Volt Coloured Range

NEW



SR25MBN Brushed Nickel PVD

- Brushed Nickel PVD Plated
- Straight Round Profile
- W550 x H550 x D122mm
- 4 Bars
- 41 Watt Output

Stock Code	RRP \$ Incl.
SR25MBN	\$719.00

BS44MW Satin White Coated

- Satin White Powder Coated
- Straight Round Profile
- W600 x H800 x D122mm
- 7 Bars
- 80 Watt Output

Stock Code	RRP \$ Incl.
BS44MW	\$679.00

7

Seven year warranty

304

Safe for use in bathrooms



Multiflex wiring on all legs

NEW



SR44MBN Brushed Nickel PVD

- Brushed Nickel PVD Plated
- Straight Round Profile
- W600 x H800 x D122mm
- 7 Bars
- 80 Watt Output

Stock Code	RRP \$ Incl.
SR44MBN	\$955.00

WHILE STOCKS LAST



SR44MRG Polished Rose Gold PVD

- Polished Rose Gold PVD Plated
- Straight Round Profile
- W600 x H800 x D122mm
- 7 Bars
- 80 Watt Output

Stock Code	RRP \$ Incl.
SR44MRG	\$899.00

201

Quality Stainless Steel



Hard-wired or plug-in



Vertical and horizontal bar sizes



Model shown: SV35

240Volt Swivel Range



SV24

- Polished Stainless Steel
- Straight Round Profile
- W600 x H540 x D99mm
- 4 Bars
- 48 Watt Output

Stock Code	RRP \$ Incl.
SV24	\$539.00

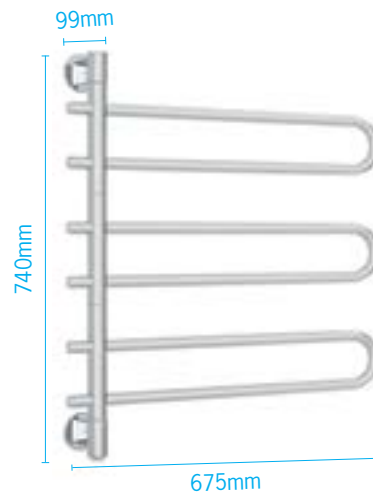

SV43

- Polished Stainless Steel
- Straight Round Profile
- W675 x H740 x D99mm
- 6 Bars
- 77 Watt Output

Stock Code	RRP \$ Incl.
SV43	\$679.00

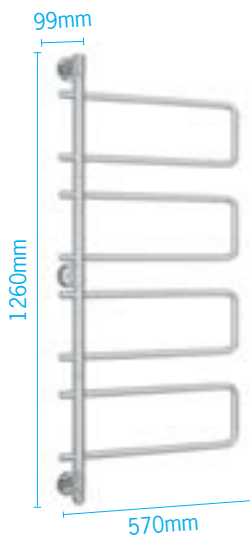

SV68

- Polished Stainless Steel
- Straight Round Profile
- W570 x H1260 x D99mm
- 8 Bars
- 88 Watt Output

Stock Code	RRP \$ Incl.
SV68	\$929.00



SV35

- Polished Stainless Steel
- Straight Square Profile
- W600 x H540 x D99mm
- 4 Bars
- 48 Watt Output

Stock Code	RRP \$ Incl.
SV35	\$639.00



Ten year warranty



Safe for use in bathrooms



Exposed or concealed wiring



Quality Stainless Steel



On/off switch on unit



Bars swivel independently



Vertical and horizontal bar sizes

240Volt Floor to Ceiling Rail



Seven year warranty



Safe for use in bathrooms



Top or bottom concealed wiring



Quality Stainless Steel



Can be cut down to 2400mm



Vertical and horizontal bar sizes

FC70R

- Polished Stainless Steel
- Straight Round Profile
- W700 x H2400-3000 x D50mm
- 16 Bars
- 230 Watt Output

Stock Code	RRP \$ Incl.
FC70R	\$2,459.00

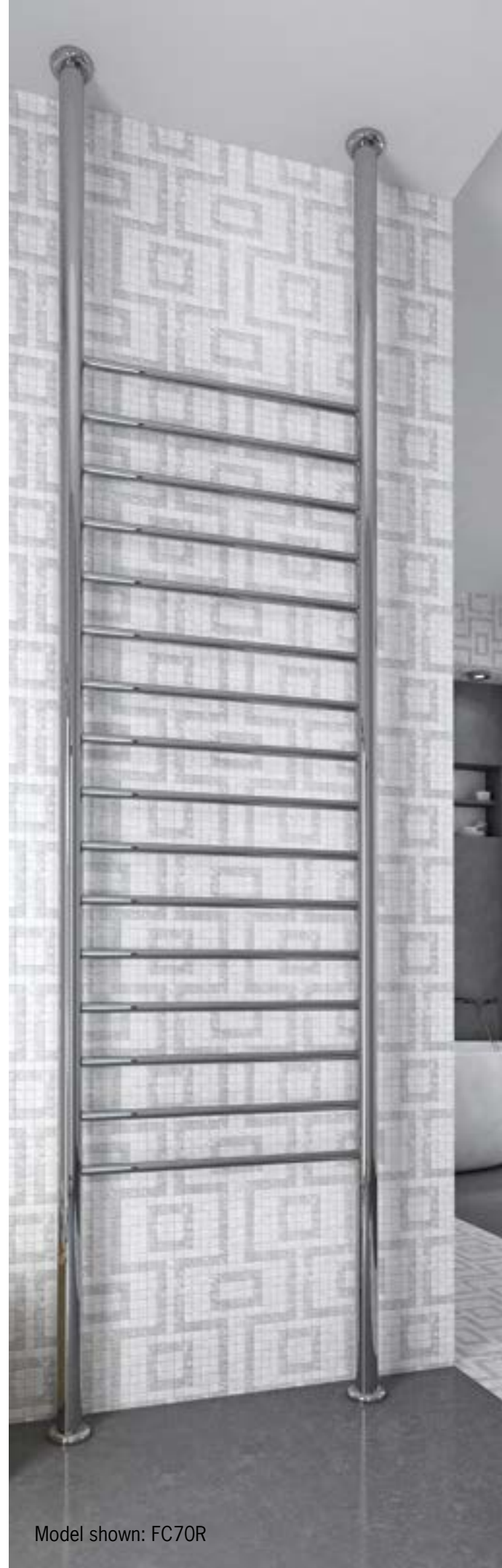

Model shown: FC70R



Model Shown: FS66E

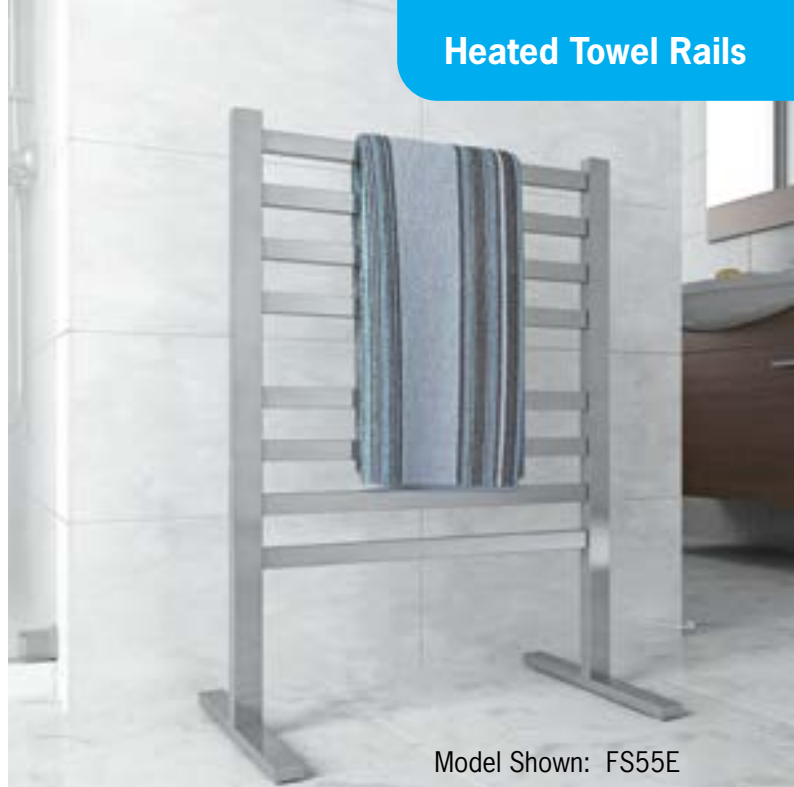

Model Shown: FS55E



Seven year warranty



Safe for use in bathrooms



Exposed plug-in wiring



Quality Stainless Steel

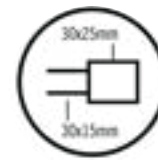

Square vertical and horizontal bar sizes



Round vertical and horizontal bar sizes

240Volt Free Standing Range



FS66E

- ✔ Polished Stainless Steel
- ✔ Straight Round Profile
- ✔ W600 x H1080 x D300mm
- ✔ 1.4m lead with plug
- ✔ 8 Bars
- ✔ 100 Watt Output

Stock Code RRP \$ Incl.

FS66E \$469.00



FS55E

- ✔ Polished Stainless Steel
- ✔ Straight Flat Profile
- ✔ W590 x H900 x D355mm
- ✔ 1.4m lead with plug
- ✔ 8 Bars
- ✔ 119 Watt Output

Stock Code RRP \$ Incl.

FS55E \$539.00



Model shown: SB34M



Ten year warranty



Safe for use in bathrooms



Multiflex wiring on all four legs



Quality Stainless Steel



Hard-wired or plug-in



Vertical and horizontal bar sizes

240V Heritage Rail

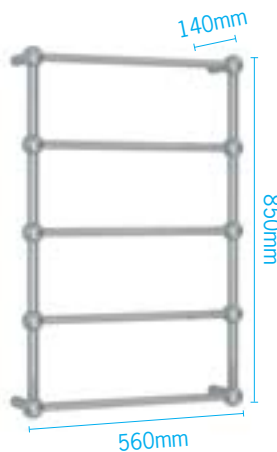

SB34M

- Polished Stainless Steel
- Straight Round Profile with Ball Detail
- W560 x H850 x D140mm
- 5 Bars
- 60 Watt Output

Stock Code	RRP \$ Incl.
SB34M	\$1,189.00

Thermorail Custom Plated Colour Finishes

Thermorail offers a selection of Heated Towel Rails which can be custom plated in a range of finishes to suit your bathroom.



Custom Plated

As a custom plated range, we can offer a wide variety of colours to match your bathroom tapware. Scan the QR Code below to view custom plated finishes.



Plated Lead Time

The rails are plated to order, this means there is a 4-6 week lead time on the plating.



5 Year Warranty

The warranty on the plated range of rails is 5 years. Scan the QR Code to view warranty details for the custom plated range.



Scan to view more details on our custom plated range

Custom Plating Available Styles

Ladder Range

- ☑ Straight Round 6 Bar
- ☑ Straight Round 8 Bar



Vertical Bar Range

- ☑ Round Profile
- ☑ Pill Profile



Single Bar Range

- ☑ Round Profile
- ☑ Square Profile
- ☑ Pill Profile



Thermorail Timers

Why consider a Towel Rail Timer?

A timer is recommended for controlling the usage of your Heated Towel Rail. The advantage of the timer is that it allows you to simply set and forget whilst experiencing a warm dry towel every time you use the bathroom. It also ensures that the rail is never left on in the bathroom therefore it helps you to reduce running costs.

7 Day Touchscreen Timer

The TRTS Thermorail Timer is a digital touch screen timer ideal for controlling Thermorails. With the TRTS Thermorail Timer you have the ability to program each day individually or 7 days the same or program week days to one schedule and weekends different. This timer has 4 switching times (2on/2off) per day and is simple to program with large easy to read characters.

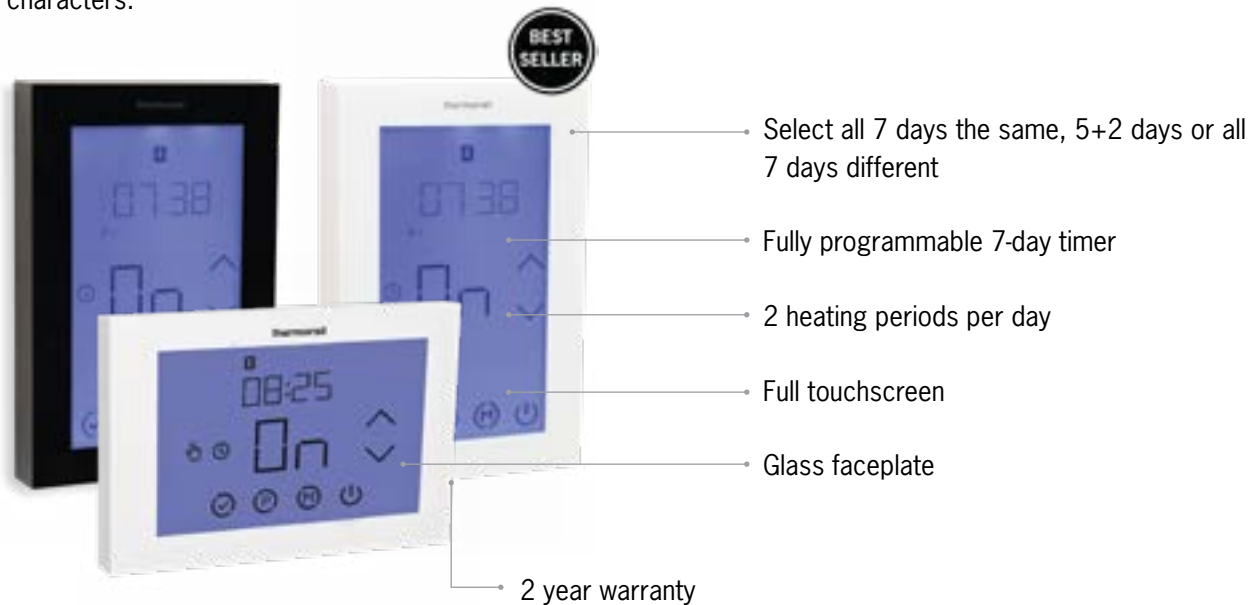

Stock Code	Colour	Orientation	Size (mm)	IP Rating	Max Load	RRP \$ Incl.
TRTS	White	Portrait	W80 X H120 X D45 (25mm in Wall)	IP30	16A	\$215.00
TRTSB	Black	Portrait	W80 X H120 X D45 (25mm in Wall)	IP30	16A	\$215.00
TRTSL	White	Landscape	W120 x H80 x D45 (25mm in Wall)	IP30	16A	\$215.00

Underfloor Heating and Heated Towel Rail?

Check out our Thermotouch 4.3dC Dual Control Thermostat on pages 54-55 which allows you to control both your Underfloor Heating & Heated Towel Rail on the one controller.



Eco Timer

The Eco Timer is a simple timing device designed to go behind the switch plate (supplied with the ET12C and ET12CB timer). The timer operates on a 12 hour schedule meaning it will be on at the same time morning and evening each day of the week. The programmed time can be selected for a period from 1 to 11 hours and three heat settings can be selected: 50%, 75% or 100%.

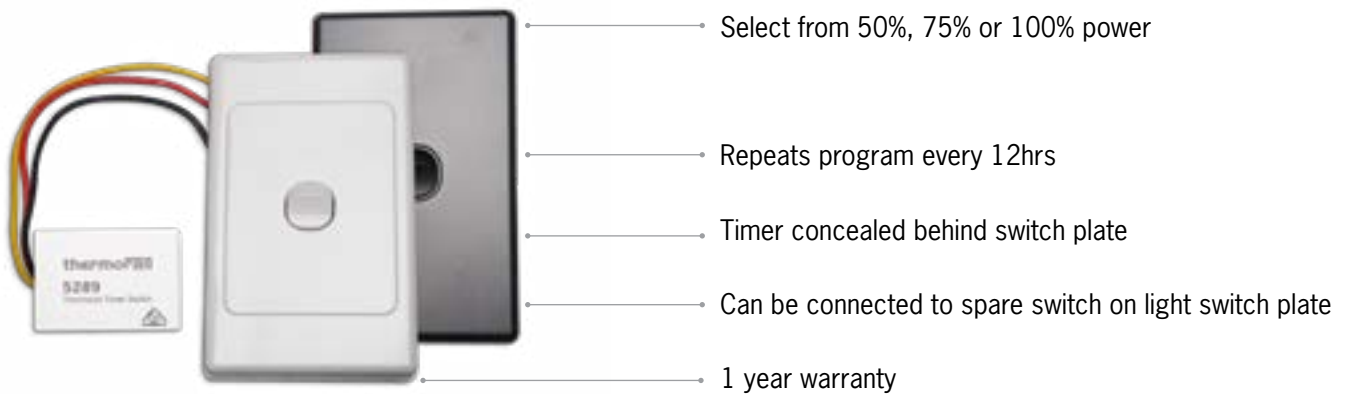

Stock Code	Description	Size (mm)	IP Rating	Max Load	RRP \$ Incl.
5289	Timer Only (No switchplate)	W49 x H35 x D27	IP30	1A	\$85.00
ET12C	White switch plate and 5289 Timer	W70 x H120 x D10	IP30	1A	\$107.00
ET12CB	Black switch plate and 5289 Timer	W70 x H120 x D10	IP30	1A	\$107.00

EB11 Boost Timer

The EB11 Boost Timer allows you to boost the heat for 5 different periods of time without having to remember to switch it off. Your Thermorail will revert back to 'Off' mode after the selected amount of time, thus reducing energy consumption. These units are only suitable for resistive loads and therefore can only be used to control 240V Heated Towel Rails.

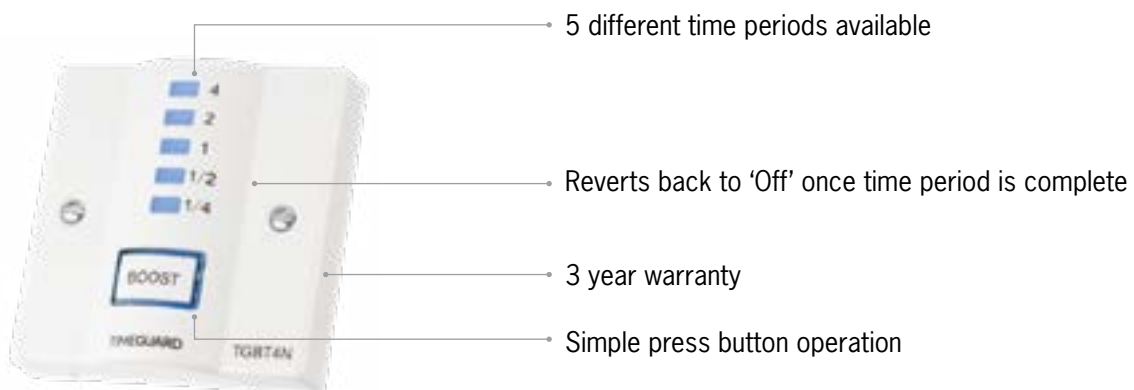

Stock Code	Colour	Size (mm)	IP Rating	Max Load	RRP \$ Incl.
EB11	White	W86 x H86 x D22	IP20	13A	\$215.00





Model shown: USR54

Non-Heated Round Range



Vertical and horizontal bar sizes



USR54

- Polished Stainless Steel
- Straight Round Profile
- W630 x H800 x D122mm
- 5 Bars
- 10 Year Warranty

Stock Code	RRP \$ Incl.
USR54	\$429.00

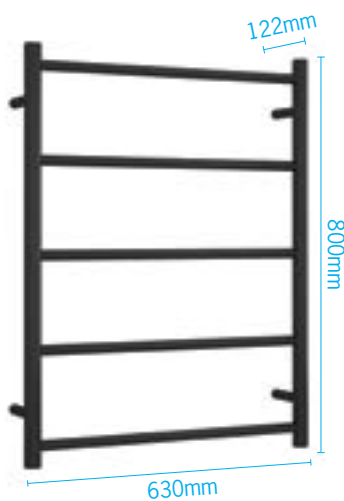

USR54B

- Matt Black Powder Coated
- Straight Round Profile
- W630 x H800 x D122mm
- 5 Bars
- 7 Year Warranty

Stock Code	RRP \$ Incl.
USR54B	\$529.00

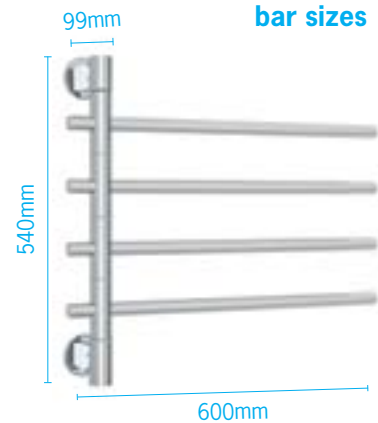

USV24

- Polished Stainless Steel
- Straight Round Profile
- W600 x H540 x D99mm
- 4 Bars
- 10 Year Warranty

Stock Code	RRP \$ Incl.
USV24	\$459.00



Model shown: USV35

Non-Heated Square Range

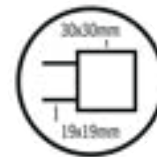

Square vertical and horizontal bar sizes



Round vertical and horizontal bar sizes



USS56

- Polished Stainless Steel
- Straight Square Profile
- W650 x H1000 x D120mm
- 5 Bars
- 10 Year Warranty



USS56B

- Matt Black Powder Coated
- Straight Square Profile
- W650 x H1000 x D120mm
- 5 Bars
- 7 Year Warranty

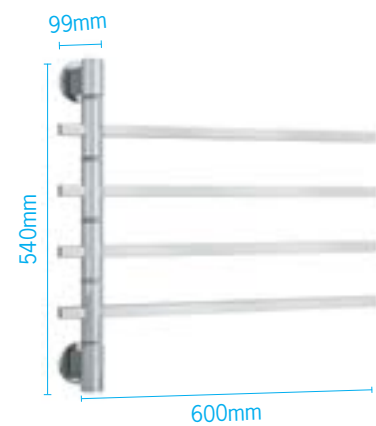

USV35

- Polished Stainless Steel
- Straight Square Profile
- W600 x H540 x D99mm
- 4 Bars
- 10 Year Warranty

Stock Code	RRP \$ Incl.
USS56	\$455.00

Stock Code	RRP \$ Incl.
USS56B	\$559.00

Stock Code	RRP \$ Incl.
USV35	\$539.00

Multiflex Wiring Explained

Our Multiflex Wiring offers flexibility and ease of wiring for your Heated Towel Rail.

Multiflex wiring means there is a range of different wiring options within the one Heated Towel Rail so the wiring can be decided at the time of installation. The wiring options available are either the top or the bottom of the rail, on the left or right hand side, making it possible to come from any of the four mounting points. Wiring can also be exposed (plug-in) or concealed (hard-wired).

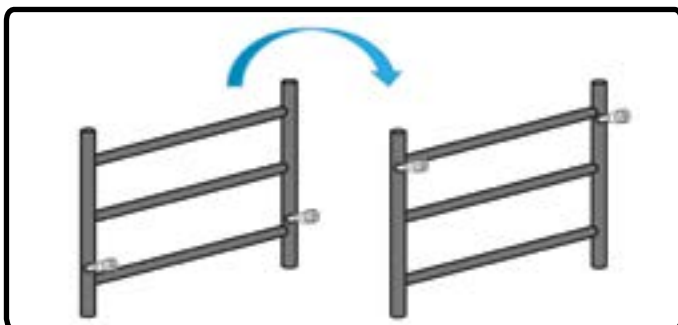

Top and bottom wiring

Wiring connection points come as standard at the base of the unit.

Due to being a dry element rail this can be turned over/upside down (there is no difference between the top and bottom) and you can have the connection points at the top of the unit.

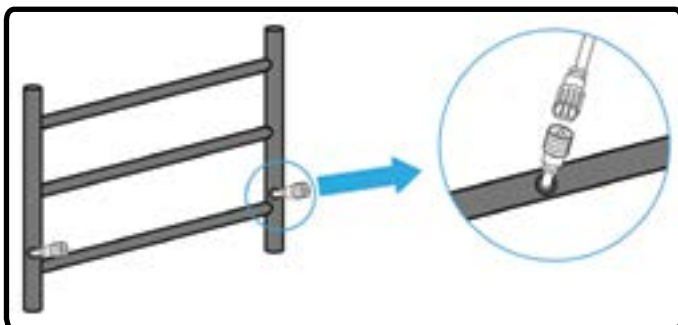

Left and right hand wiring

The unit has wiring connection points on both the left and right hand side and the lead comes as a separate part.

The lead can be easily plugged into the desired side during installation.

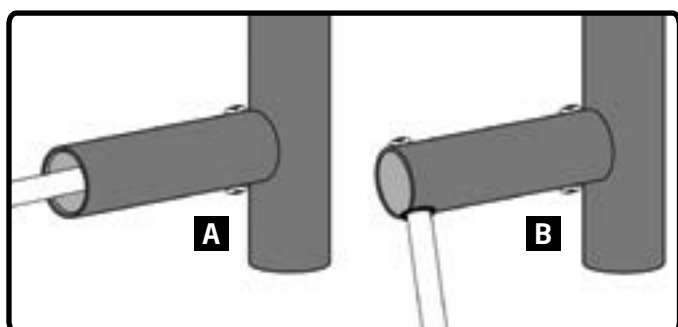

Concealed and exposed wiring

The Thermorail can be hard-wired (concealed) through one of the mounting legs providing a clean, sleek look. (A)

Alternatively, the Thermorail can have exposed wiring which allows the wiring to come out the base of one of the mounting legs on the side closest to the wall and get plugged into a power point. (B)



Scan the code to view our video that explains how Multiflex wiring works.

Positioning your Thermorail

Bathrooms are zoned according to Australian Standards. Positioning of a Thermorail Heated Towel Rail is the responsibility of the electrician.

Electrical safety in wet areas

ZONE 0

Inside bath or shower. Any fitting used in this zone must be low voltage (max 12V) or a rating of at least IPX7 is required. Transformers and switches must be outside of zone 1.

ZONE 1

Area above the bath to a height of 2.25m from the floor. A minimum of IPX4 (IP44) needed. Thermorails in this zone must be hard-wired and protected by a 30mA RCD on the circuit. The switch must be outside of Zone 2.

ZONE 2

Covers 600mm outside the perimeter of the bath to a height of 2.25m from the floor. Also covers a radius of 600mm around a wash basin. Minimum rating of IPX4 (IP44) needed in this zone.

OUTSIDE ZONES

No specific requirements unless water jets are intended for cleaning purposes.

ALL ZONES

All electrical circuits in bathrooms must be protected by an RCD. If exposed to water jets such as a shower, a rating of at least IPX5 is required.



(Diagram for illustrative purposes only)

IP Ratings

Electrical fixtures in bathrooms are certified using an IP (Ingress Protection) rating. The IP is followed by 2 numbers and refers to the level of protection against the ingress of foreign bodies (1st number) and protection against the ingress of liquids (2nd number). The higher the second number is the greater protection the item has from water ingress.

Zonal Guidelines

All domestic installations must comply with guidelines based on the zonal requirements. Thermogroup recommends that all electrical work is carried out by a qualified electrician in accordance with current regulations. Consult your electrician for wiring requirements in your area.

Heated Towel Rail FAQs

We have put together a range of answers to the most frequently asked questions about Thermorail Heated Towel Rails. If you have a question that isn't answered here, please give us a call or scan the QR Code to visit the Thermogroup Learning Centre.



Why do I need a Heated Towel Rail?

Heated Towel Rails were once considered a luxury but now are widely used to provide warm dry towels in the cold winter months. Heated Towel Rails also create a more hygienic environment in your bathroom by keeping towels dry and free from germs or mould. Heated Towel Rails also help save electricity and water as they reduce the need for continuous towel washing and tumble drying.

What temperature will the towel rail get to?

A Thermorail Heated Towel Rail will generally heat up to around 35 degrees and heats up a lot quicker than a hydronic/liquid filled rail. When a towel is placed over the bars the towel insulates the rail and absorbs the heat, meaning that beneath the towel the temperature will rise to between 50 – 55 degrees. A hydronic/liquid filled rail heats the entire rail to 55 degrees, taking longer to reach temperature, but helping add warmth to the bathroom. As the element is heating the water and not the air, covering the rail with a towel will not cause it to get any hotter.

What does it cost to run a Heated Towel Rail?

A standard dry element rail can cost as little as 1 cent per hour to run. This can be further reduced by adding a timer to provide optimum control over running times.

What is the heat up time on my towel rail?

An electric towel rail will take 5 minutes to start getting warm and within approximately 30 minutes it will reach optimum temperature. A hydronic or liquid filled rail will take closer to an hour to reach its optimum temperature. Although the towel rail will get to temperature within 30 minutes it will take 1½- 3hrs to dry the towels (Dependant on ambient temperature and the size, quantity and dampness of the towels).

What is the best way to dry my towels?

Contrary to what most people think, if the towel is folded when placed on the towel rail it will actually dry better than if the towel is just draped over in a single layer. This is because the folded towel will insulate the towel rail allowing it to dry the towel quicker.

My towels aren't getting hot enough, is something wrong?

Towel rails in Australia are designed to dry and gently warm the towel but not to get as hot as a radiator. So, although the towel rail will dry your towel and provide some warmth it will not be heated to the extent that a tumble dryer will heat your towel.

How do I control my Heated Towel Rail?

Thermorail Heated Towel Rails are safe to be left running continuously however most times it is preferable to have the ability to control when your Heated Towel Rail is on and off, thus saving you energy. The majority of the range of Thermorails don't have a switch on the unit but can be very simply wired to a standard switch. Alternatively, you can wire the Thermorail to a timer that can be programmed to turn on and off to suit your lifestyle. See Thermorail Timers on page 116-117.

Will the towel rail heat my bathroom?

Thermorail electric Heated Towel Rails are designed as a towel warmer only and won't add heat to your bathroom. However, hydronic and liquid filled rails are designed to not only heat your towel, but also add some warmth to the bathroom although they are still not designed as bathroom heaters.

When ordering a Thermorail do I need to specify which wiring option I require?

Any Thermorail that has Multiflex wiring (symbolised by an 'M' after the numbers in the code) has the option of being concealed or exposed wired at any of the four mounting points. All the parts required for any of these mounting options come as standard with the Thermorail – you do not need to purchase anything extra or specify the wiring required, this can be decided at the time of installation.

What is Multiflex wiring?

Multiflex wiring means there is a range of different wiring options within the one rail so the wiring can be decided at the time of installation. The multiple wiring options available are at either the top or the bottom of the rail, on the left or right hand side - making it possible to come from any of the four mounting points. Wiring can also be exposed (plug-in) or concealed (hard-wired). See more details on page 120.

Can I retrofit a Heated Towel Rail into an existing bathroom?

The majority of the Thermorail range (excluding the 12V Range) have the option to have exposed wiring. This means that the Heated Towel Rail can be very easily mounted to your wall in an existing bathroom and plugged into a nearby power point meaning that no wiring is required in the wall or roof cavity.

Can I install the Heated Towel Rail myself?

The towel rail is supplied with complete installation instructions so if the towel rail is going to be plugged into a power point then you can easily install the towel rail yourself. However, if you are hard-wiring the towel rail then you will require a qualified electrician to wire it up.

What does the IP Rating mean?

IP rating is the ingress protection rating on electrical products that determines where an electrical product can be installed in the bathroom. More information on page 121.

Additional warranty details are found on pages 150-154.

Where can I place my Heated Towel Rail in my bathroom?

The majority of the Thermorail range have an IP55 rating which is one of the highest ratings available for Heated Towel Rails. This allows for placing the towel rail in most areas of the bathroom however you should always consult your electrician to ensure the chosen position is suitable for the Heated Towel Rail you have selected.

What if I wanted a heated model in non-heated?

The majority of the Thermorail Heated Towel Rails have the wiring concealed in the leg and no switch located on the rail. This means you can mount the rail to the wall without connecting the rail to power and use it as a non-heated rail. There will be no visible difference.

What are the towel rails made from?

All of the dry electric towel rails are made from quality Stainless Steel and polished to a mirror finish (unless otherwise specified).

How can I take care of my Stainless Steel product?

The Stainless Steel is very hardwearing and easy to maintain. Cleaning the towel rail should be done with a soft cloth and avoid hard scrubbing, scratching or using acid based cleaning products.

Are 12V rails more efficient than 240V rails?

No, a 12V rail will use the same amount of electricity as a 240V rail of the same wattage.

Do 12V Thermorails get as warm as standard 240V Thermorails?

The 12V Thermorail range will get as warm and dry your towels as efficiently as the standard 240V Thermorails. This is because the amount of heat output is related to the wattage of the rail rather than the voltage, so a 12V Thermorail will put out the same amount of heat as a 240V Thermorail with the same wattage.

Where should the transformer be installed?

The transformer can be installed in the ceiling or the wall cavity no further than two metres from the rails. If mounting in the wall cavity the transformer must be behind a switch plate to enable access and the transformer needs to have ventilation.

How many single bar towel rails can I have in a set?

The number of Single Bar 12V Rails that you include in a set is only limited by your imagination. To dry and warm your towels effectively you will need a minimum of 3 rails per set.

Do I need to order a mounting system?

No, all rails have the parts needed for installation however the mounting system is recommended when installing multiple single horizontal bars as it makes it easier for the cable management and spacing. Refer to page 84.



Model shown: DP5010HN/GT

Ablaze Mirrors

Contents

Premium Backlit Mirrors	126
Lit Magnifying Mirrors	130
Non-lit Magnifying Mirrors	132
Black Frame Mirrors	134
Frameless Mirrors	136
Thermomirror Demister Pads	146
Mirror Cabinet	148
Ablaze Mirror FAQ's	149

Add a touch of luxury to every bathroom

When you are looking to add that little bit extra to your bathroom design there is sure to be something that suits you from our extensive mirror range.



Backlit Mirrors

Backlit mirrors enhance ambience and add luxury to your bathroom.

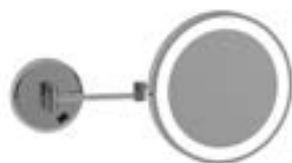

Magnified Mirrors

Wall mounted magnifying mirrors, available in a range of styles to suit your needs for make-up application or shaving.



Framed Mirrors

Black framed mirrors suited to any room with dark modern tones.



Frameless Mirrors

Range of plain mirrors to suit all styles and budgets.



Mirror Demisters

Thermomirror demister pads ensure a condensation free mirror after your hot shower or bath.



Mirror Cabinet

The round door mirror cabinet offers a great mirror storage option in a bathroom.

Premium Backlit Mirrors

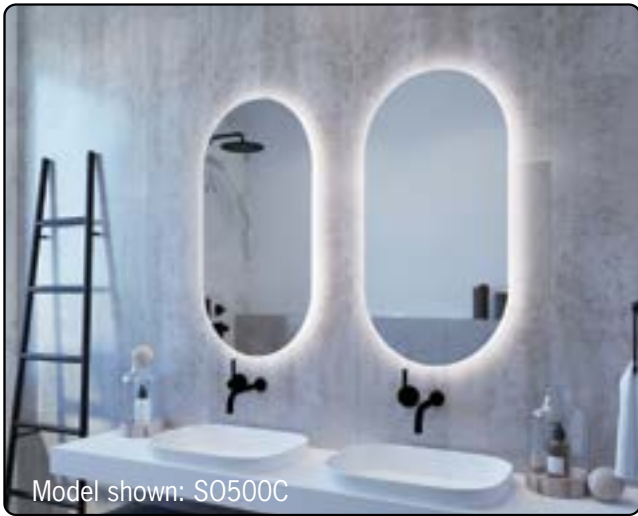

S0 Range

- ☑ Pill shape
- ☑ Polished edge
- ☑ Portrait mounting only
- ☑ Warm or cool lighting options
- ☑ Demister included

Stock Code	Light	Size W x H x D (mm)	Output (W)	RRP \$ Incl.
S0500C	Cool	500 x 1000 x 45	61	\$949.00
S0500W	Warm	500 x 1000 x 45	61	\$949.00



AS Range

- ☑ Arch shape
- ☑ Polished edge
- ☑ Portrait mounting only
- ☑ Warm or cool lighting options
- ☑ Demister included

Stock Code	Light	Size W x H x D (mm)	Output (W)	RRP \$ Incl.
AS500C	Cool	500 x 800 x 45	47	\$929.00
AS500W	Warm	500 x 800 x 45	47	\$929.00

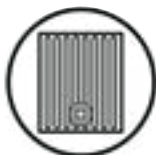

Demister included



Warm and cool lighting options



No switch on unit



LED lighting



Three year warranty

Premium Backlit Mirrors



Model shown: SS128C

SS Range

- ☉ Rectangle shape
- ☉ Polished edge
- ☉ Landscape or portrait mounting
- ☉ Cool lighting only
- ☉ Demister included

Stock Code	Light	Size W x H x D (mm)	Output (W)	RRP \$ Incl.
SS759C	Cool	900 x 750 x 45	85	\$1,249.00
SS128C	Cool	1200 x 800 x 45	108	\$1,599.00



Model shown: RS600C

RS Range

- ☉ Round shape
- ☉ Polished edge
- ☉ Warm or cool lighting options
- ☉ Demister included

Stock Code	Light	Size W x H x D (mm)	Output (W)	RRP \$ Incl.
RS600C	Cool	600 ø x 45	37	\$799.00
RS600W	Warm	600 ø x 45	37	\$799.00
RS900C	Cool	900 ø x 45	80	\$1,279.00
RS900W	Warm	900 ø x 45	80	\$1,279.00

Premium Back-lit Mirrors



Model shown: RB610C

RB Range

- ☑ Round shape
- ☑ Polished edge
- ☑ Warm and cool lighting options
- ☑ No demister included

Stock Code	Light	Size W x H x D (mm)	Output (W)	RRP \$ Incl.
RB610C	Cool	610 ø x 45	18	\$839.00
RB610W	Warm	610 ø x 45	18	\$839.00



Model shown: SR1118C

SR Range

- ☑ Rectangle shape
- ☑ Polished edge
- ☑ Portrait or landscape mounting
- ☑ Cool lighting only
- ☑ Demister included

Stock Code	Light	Size W x H x D (mm)	Output (W)	RRP \$ Incl.
SR759C	Cool	900 x 750 x 45	62	\$1,299.00
SR1118C	Cool	1200 x 800 x 45	86	\$1,669.00

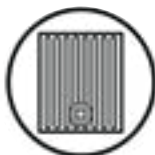

Demister included



Warm and cool lighting options



No switch on unit



LED lighting



Three years warranty

Premium Back-lit Mirrors

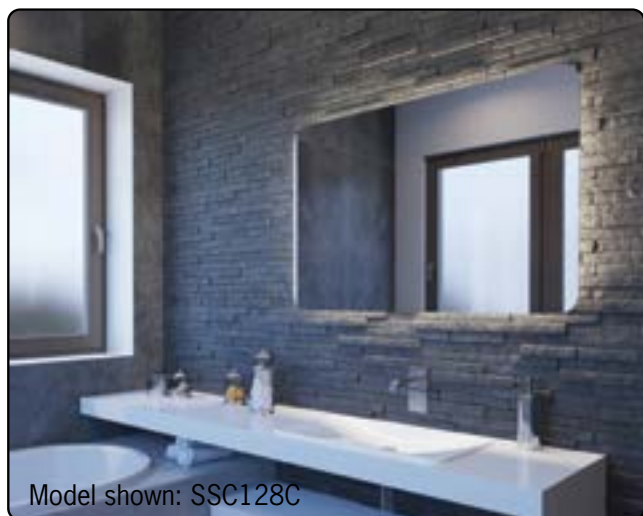

Model shown: SSC128C

SSC Range

- ☑ Rectangle with 80mm ø rounded corners
- ☑ Polished edge
- ☑ Landscape mounting only
- ☑ Cool lighting only
- ☑ Demister included

Stock Code	Light	Size W x H x D (mm)	Output (W)	RRP \$ Incl.
SSC128C	Cool	1200 x 800 x 45	108	\$1,599.00



Model shown: S900C

S Range

- ☑ Square and rectangle shape
- ☑ Sandblasted edge
- ☑ Portrait or landscape mounting
- ☑ Cool lighting only
- ☑ Demister included

Stock Code	Light	Size W x H x D (mm)	Output (W)	RRP \$ Incl.
S500C	Cool	750 x 500 x 45	35	\$819.00
S759C	Cool	900 x 750 x 45	57	\$1,229.00
S900C	Cool	900 x 900 x 45	83	\$1,399.00
S1200C	Cool	1200 x 800 x 45	92	\$1,599.00
S1500C	Cool	1500 x 800 x 45	111	\$1,699.00

Lit Magnifying Mirrors

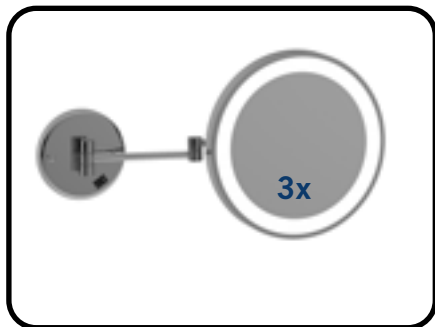

L252CSMC/L252CSME

- ☑ Chrome Plated
- ☑ 3x Magnification
- ☑ 250mm Diameter
- ☑ Arm Extends to 390mm
- ☑ 3 Watt White LED Light
- ☑ Concealed (C) or Exposed (E) Wiring

Stock Code	RRP \$ Incl.
L252CSMC	\$459.00
L252CSME	\$459.00

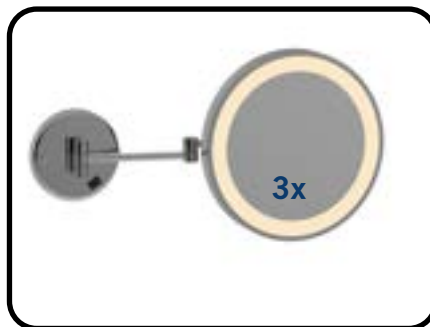

L253CSMC

- ☑ Chrome Plated
- ☑ 3x Magnification
- ☑ 250mm Diameter
- ☑ Arm Extends to 390mm
- ☑ 3 Watt Warm LED Light
- ☑ Concealed Wiring

Stock Code	RRP \$ Incl.
L253CSMC	\$459.00

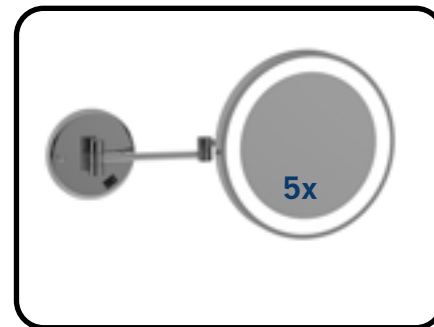

L255CSMC/L255CSME

- ☑ Chrome Plated
- ☑ 5x Magnification
- ☑ 250mm Diameter
- ☑ Arm Extends to 390mm
- ☑ 3 Watt White LED Light
- ☑ Concealed (C) or Exposed (E) Wiring

Stock Code	RRP \$ Incl.
L255CSMC	\$469.00
L255CSME	\$469.00

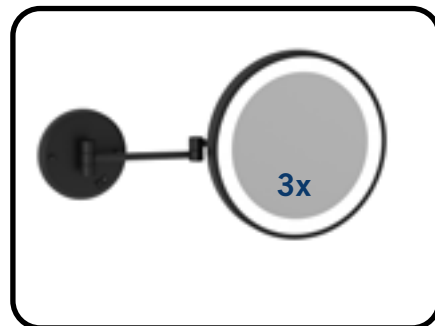

L252CSMCB

- ☑ Matt Black Coated
- ☑ 3x Magnification
- ☑ 250mm Diameter
- ☑ Arm Extends to 390mm
- ☑ 3 Watt White LED Light
- ☑ Concealed Wiring

Stock Code	RRP \$ Incl.
L252CSMCB	\$499.00

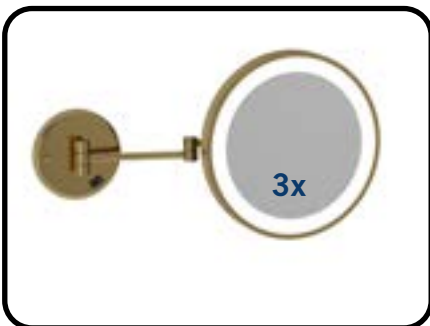

L252GSMC

- ☑ Polished Gold Plated
- ☑ 3x Magnification
- ☑ 250mm Diameter
- ☑ Arm Extends to 390mm
- ☑ 3 Watt White LED Light
- ☑ Concealed Wiring

Stock Code	RRP \$ Incl.
L252GSMC	\$589.00

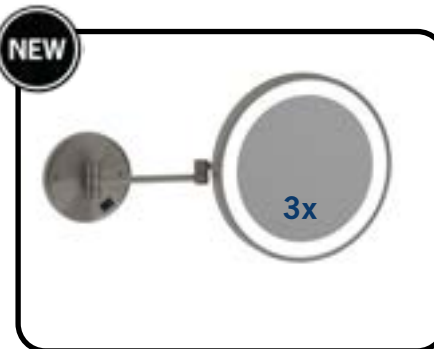

L252CSMCBN

- ☑ Brushed Nickel Plated
- ☑ 3x Magnification
- ☑ 250mm Diameter
- ☑ Arm Extends to 390mm
- ☑ 3 Watt White LED Light
- ☑ Concealed Wiring

Stock Code	RRP \$ Incl.
L252CSMCBN	\$569.00

Stock codes ending in 'C' represent Concealed Wiring (Hard-wired). Stock codes ending in 'E' represent Exposed Wiring (Plug-in).

Lit Magnifying Mirrors

NEW

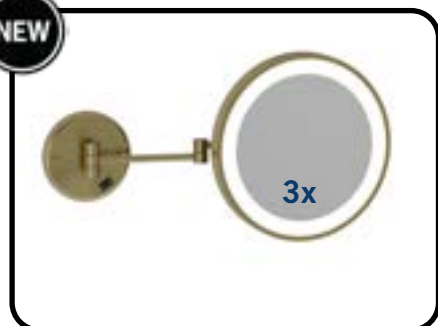

L252CSMCBB

- ✔ Brushed Brass Plated
- ✔ 3x Magnification
- ✔ 250mm Diameter
- ✔ Arm Extends to 390mm
- ✔ 3 Watt White LED Light
- ✔ Concealed Wiring

Stock Code	RRP \$ Incl.
L252CSMCBB	\$569.00



L155CSMC

- ✔ Chrome Plated
- ✔ Double Sided 1x and 5x Magnification
- ✔ 200mm Diameter
- ✔ Arm Extends to 320mm
- ✔ 3 Watt White LED Light
- ✔ Concealed Wiring

Stock Code	RRP \$ Incl.
L155CSMC	\$529.00



L258CSMC/L258CSME

- ✔ Chrome Plated
- ✔ Double Sided 1x and 8x Magnification
- ✔ 200mm Diameter
- ✔ Arm Extends to 320mm
- ✔ 3 Watt White LED Light
- ✔ Concealed (C) or Exposed (E) Wiring

Stock Code	RRP \$ Incl.
L258CSMC	\$549.00
L258CSME	\$549.00



LS205CSMC/LS205CSME

- ✔ Chrome Plated
- ✔ 3x Magnification
- ✔ 200 x 200mm
- ✔ Arm Extends to 390mm
- ✔ 3 Watt White LED Light
- ✔ Concealed (C) or Exposed (E) Wiring

Stock Code	RRP \$ Incl.
LS205CSMC	\$549.00
LS205CSME	\$549.00



LS205CSMCB

- ✔ Matt Black Finish
- ✔ 3x Magnification
- ✔ 200 x 200mm
- ✔ Arm Extends to 390mm
- ✔ 3 Watt White LED Light
- ✔ Concealed Wiring

Stock Code	RRP \$ Incl.
LS205CSMCB	\$589.00



One year warranty



On/off switch on unit



Safe for use in bathrooms

Stock codes ending in 'C' represent Concealed Wiring (Hard-wired). Stock codes ending in 'E' represent Exposed Wiring (Plug-in).

Non-lit Magnifying Mirrors

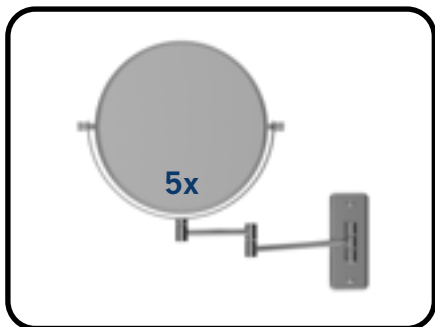

R16SM

- ☑ Chrome Plated
- ☑ Double Sided Mirror
- ☑ 1x and 5x Magnification
- ☑ 200mm Diameter
- ☑ Arm Extends to 330mm

Stock Code	RRP \$ Incl.
R16SM	\$199.00

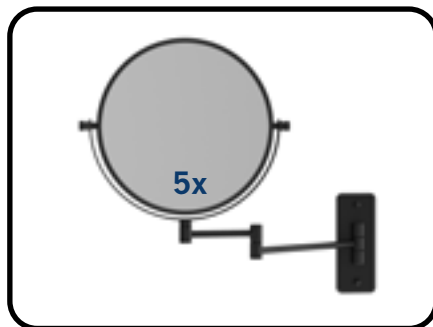

R16SMB

- ☑ Matt Black Finish
- ☑ Double Sided Mirror
- ☑ 1x and 5x Magnification
- ☑ 200mm Diameter
- ☑ Arm Extends to 330mm

Stock Code	RRP \$ Incl.
R16SMB	\$225.00

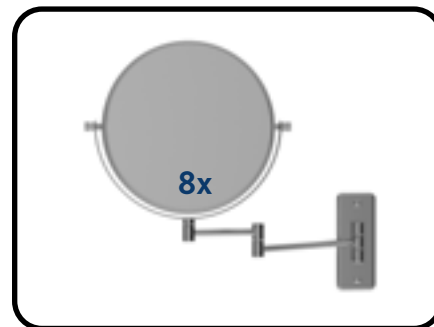

R18SM

- ☑ Chrome Plated
- ☑ Double Sided Mirror
- ☑ 1x and 8x Magnification
- ☑ 200mm Diameter
- ☑ Arm Extends to 330mm

Stock Code	RRP \$ Incl.
R18SM	\$225.00

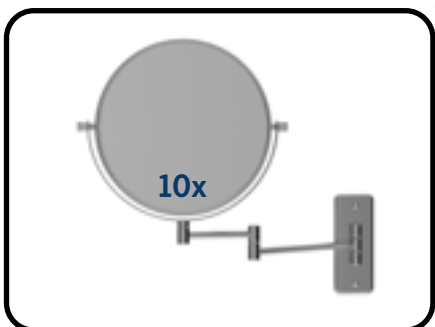

R10SM

- ☑ Chrome Plated
- ☑ Double Sided Mirror
- ☑ 1x and 10x Magnification
- ☑ 200mm Diameter
- ☑ Arm Extends to 330mm

Stock Code	RRP \$ Incl.
R10SM	\$255.00



R16SMBB

- ☑ Brushed Brass Plated
- ☑ Double Sided Mirror
- ☑ 1x and 5x Magnification
- ☑ 200mm Diameter
- ☑ Arm Extends to 330mm

Stock Code	RRP \$ Incl.
R16SMBB	\$299.00

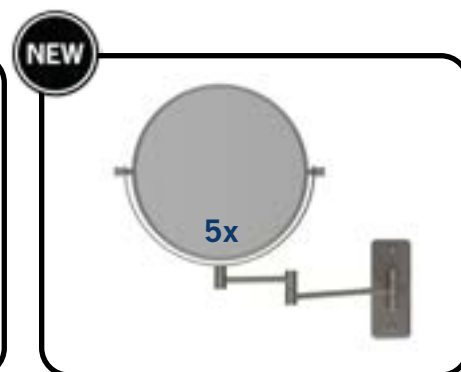

R16SMBN

- ☑ Brushed Nickel Plated
- ☑ Double Sided Mirror
- ☑ 1x and 5x Magnification
- ☑ 200mm Diameter
- ☑ Arm Extends to 330mm

Stock Code	RRP \$ Incl.
R16SMBN	\$299.00

Non-lit Magnifying Mirrors

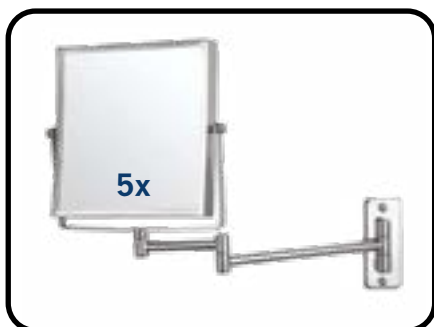

S15SM

- ☑ Chrome Plated
- ☑ Double Sided Mirror
- ☑ 1x and 5x Magnification
- ☑ 200 x 200mm
- ☑ Arm Extends to 330mm

Stock Code	RRP \$ Incl.
S15SM	\$363.00

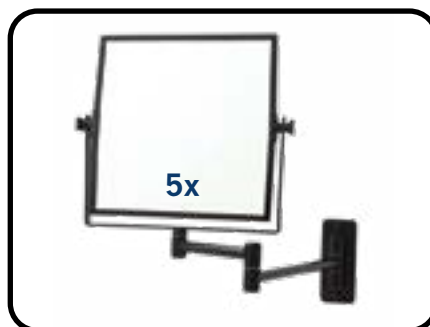

S15SMB

- ☑ Matt Black Finish
- ☑ Double Sided Mirror
- ☑ 1x and 5x Magnification
- ☑ 200 x 200mm
- ☑ Arm Extends to 330mm

Stock Code	RRP \$ Incl.
S15SMB	\$389.00



One year warranty



Simple to retrofit



Double-sided

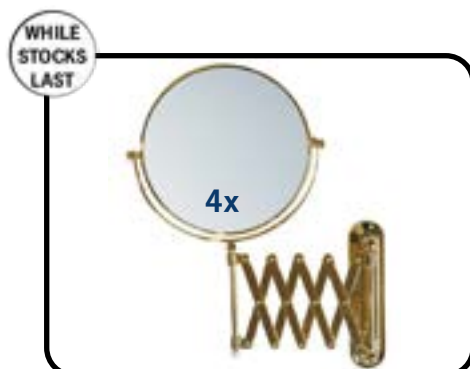

RS204GSM

- ☑ Polished Gold Plated
- ☑ Double Sided Mirror
- ☑ 1x and 4x Magnification
- ☑ 150mm Diameter
- ☑ Arm Extends to 500mm

Stock Code	RRP \$ Incl.
RS204GSM	\$239.00

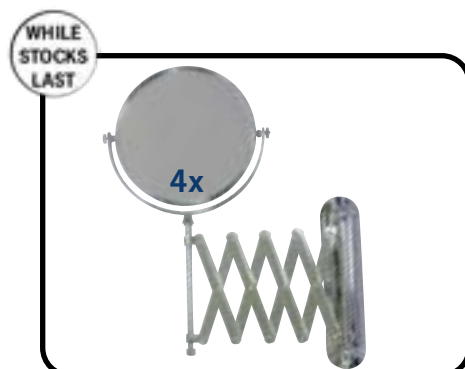

R46SM

- ☑ Chrome Plated
- ☑ Double Sided Mirror
- ☑ 1x and 4x Magnification
- ☑ 200mm Diameter
- ☑ Arm Extends to 500mm

Stock Code	RRP \$ Incl.
R46SM	\$209.00



Model shown: BMR60BF

Black Frame Mirrors



Round

- Round shape
- Matt black powder coated frame
- Option of with or without a demister

Round Mirror

Stock Code	Size (mm)	Fixing Method	RRP \$ Incl.
BMR60BF	600 ø x 50	Hangers	\$475.00
BMR90BF	900 ø x 50	Hangers	\$599.00

Mirror and Demister Package

Stock Code	Output	RRP \$ Incl.
BMR60BFD	38	\$622.00
BMR90BFD	55	\$761.00

Demister not attached to mirror; supplied as two separate components.



Rectangle

- Rectangle shape
- Matt black powder coated frame
- Option of with or without a demister

Rectangle Mirror

Stock Code	Size (mm)	Fixing Method	RRP \$ Incl.
BMS759BF	750 x 900 x 50	Hangers	\$599.00

Mirror and Demister Package

Stock Code	Output	RRP \$ Incl.
BMS759BFD	55	\$761.00

Demister not attached to mirror; supplied as two separate components.

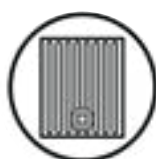

Demister option available



Portrait or landscape mounting



Metal hanger mounts



One year warranty

ablaze
MIRRORS



Model shown: MS6075HN/GT

Frameless Mirror Range

Montana Mirrors

- ☑ Rectangle and square shape
- ☑ 25mm bevel edge
- ☑ Option for glue-to-wall or hangers
- ☑ Option of with or without a demister



Safety backing film



Portrait or landscape mounting



Copper-free mirror



Two year warranty

Montana Rectangle Mirror - Glue-to-Wall

Stock Code	Size (mm)	Fixing Method	RRP \$ Incl.
MS6075GT	600 x 750	Glue-to-Wall	\$264.00
MS6090GT	600 x 900	Glue-to-Wall	\$324.00
MS9075GT	900 x 750	Glue-to-Wall	\$374.00
MS9090GT	900 x 900	Glue-to-Wall	\$404.00
MS1280GT	1200 x 800	Glue-to-Wall	\$524.00
MS1590GT	1500 x 900	Glue-to-Wall	\$664.00

Mirror and Demister Package

Stock Code	Output	RRP \$ Incl.
MS6075GTD	38W	\$411.00
MS6090GTD	55W	\$486.00
MS9075GTD	60W	\$579.00
MS9090GTD	80W	\$629.00
MS1280GTD	100W	\$773.00
MS1590GTD	145W	\$939.00

Montana Rectangle Mirror - Hangers

Stock Code	Size (mm)	Fixing Method	RRP \$ Incl.
MS6075HN	600 x 750	Hangers	\$289.00
MS6090HN	600 x 900	Hangers	\$349.00
MS9075HN	900 x 750	Hangers	\$399.00
MS9090HN	900 x 900	Hangers	\$429.00
MS1280HN	1200 x 800	Hangers	\$549.00
MS1590HN	1500 x 900	Hangers	\$689.00

Mirror and Demister Package

Stock Code	Output	RRP \$ Incl.
MS6075HND	38W	\$436.00
MS6090HND	55W	\$511.00
MS9075HND	60W	\$604.00
MS9090HND	80W	\$654.00
MS1280HND	100W	\$798.00
MS1590HND	145W	\$964.00

Mirror thickness from wall: Glue-to-wall - 5mm (Glue not included). Hangers - 14mm (including mirror)
Demister not attached to mirror; supplied as two separate components.





Model shown: KR7070HN/GT

Frameless Mirror Range

Kent Mirrors

- Round shape
- 18mm bevel edge
- Option for glue-to-wall or hangers
- Option of with or without a demister



Safety backing film



Copper-free mirror



Two year warranty

Kent Round Mirror - Glue-to-Wall

Stock Code	Size (mm)	Fixing Method	RRP \$ Incl.
KR5050GT	500Ø	Glue-to-Wall	\$219.00
KR6060GT	600Ø	Glue-to-Wall	\$269.00
KR7070GT	700Ø	Glue-to-Wall	\$329.00
KR8080GT	800Ø	Glue-to-Wall	\$389.00
KR9090GT	900Ø	Glue-to-Wall	\$429.00

Mirror and Demister Package

Stock Code	Output	RRP \$ Incl.
KR5050GTD	16W	\$334.00
KR6060GTD	24W	\$394.00
KR7070GTD	24W	\$454.00
KR8080GTD	38W	\$536.00
KR9090GTD	55W	\$591.00

Kent Round Mirror - Hangers

Stock Code	Size (mm)	Fixing Method	RRP \$ Incl.
KR5050HN	500Ø	Hangers	\$229.00
KR6060HN	600Ø	Hangers	\$279.00
KR7070HN	700Ø	Hangers	\$339.00
KR8080HN	800Ø	Hangers	\$399.00
KR9090HN	900Ø	Hangers	\$439.00

Mirror and Demister Package

Stock Code	Output	RRP \$ Incl.
-	-	-
-	-	-
KR7070HND	24W	\$464.00
KR8080HND	38W	\$546.00
KR9090HND	55W	\$601.00

Mirror thickness from wall: Glue-to-wall - 5mm (Glue not included). Hangers - 14mm (including mirror)
Demister not attached to mirror; supplied as two separate components.





Model shown: JS9090HN/GT

Frameless Mirror Range

Jackson Mirrors

- ☑ Rectangle and square shape
- ☑ Polished edge
- ☑ Option for glue-to-wall or hangers
- ☑ Option of with or without a demister



Safety backing film



Portrait or landscape mounting



Copper-free mirror



Two year warranty

Jackson Rectangle Mirror - Glue-to-Wall

Stock Code	Size (mm)	Fixing Method	RRP \$ Incl.
JS6075GT	600 x 750	Glue-to-Wall	\$244.00
JS6090GT	600 x 900	Glue-to-Wall	\$294.00
JS9075GT	900 x 750	Glue-to-Wall	\$344.00
JS9090GT	900 x 900	Glue-to-Wall	\$374.00
JS1280GT	1200 x 800	Glue-to-Wall	\$484.00
JS1590GT	1500 x 900	Glue-to-Wall	\$614.00

Mirror and Demister Package

Stock Code	Output	RRP \$ Incl.
JS6075GTD	38W	\$391.00
JS6090GTD	55W	\$456.00
JS9075GTD	60W	\$549.00
JS9090GTD	80W	\$599.00
JS1280GTD	100W	\$733.00
JS1590GTD	145W	\$889.00

Jackson Rectangle Mirror - Hangers

Stock Code	Size (mm)	Fixing Method	RRP \$ Incl.
JS6075HN	600 x 750	Hangers	\$269.00
JS6090HN	600 x 900	Hangers	\$319.00
JS9075HN	900 x 750	Hangers	\$369.00
JS9090HN	900 x 900	Hangers	\$399.00
JS1280HN	1200 x 800	Hangers	\$509.00
JS1590HN	1500 x 900	Hangers	\$639.00

Mirror and Demister Package

Stock Code	Output	RRP \$ Incl.
JS6075HND	38W	\$416.00
JS6090HND	55W	\$481.00
JS9075HND	60W	\$574.00
JS9090HND	80W	\$624.00
JS1280HND	100W	\$758.00
JS1590HND	145W	\$914.00

Mirror thickness from wall: Glue-to-wall - 5mm (Glue not included). Hangers - 14mm (including mirror)
Demister not attached to mirror; supplied as two separate components.





Model shown: RR6060HN/GT

Frameless Mirror Range

Rio Mirrors

- Round shape
- Polished edge
- Option for glue-to-wall or hangers
- Option of with or without a demister



Safety backing film



Copper-free mirror



Two year warranty

Rio Round Mirror - Glue-to-Wall

Stock Code	Size (mm)	Fixing Method	RRP \$ Incl.
RR5050GT	500Ø	Glue-to-Wall	\$189.00
RR6060GT	600Ø	Glue-to-Wall	\$219.00
RR7070GT	700Ø	Glue-to-Wall	\$279.00
RR8080GT	800Ø	Glue-to-Wall	\$329.00
RR9090GT	900Ø	Glue-to-Wall	\$379.00

Mirror and Demister Package

Stock Code	Output	RRP \$ Incl.
RR5050GTD	16W	\$304.00
RR6060GTD	24W	\$344.00
RR7070GTD	24W	\$404.00
RR8080GTD	38W	\$476.00
RR9090GTD	55W	\$541.00

Rio Round Mirror - Hangers

Stock Code	Size (mm)	Fixing Method	RRP \$ Incl.
RR5050HN	500Ø	Hangers	\$199.00
RR6060HN	600Ø	Hangers	\$229.00
RR7070HN	700Ø	Hangers	\$289.00
RR8080HN	800Ø	Hangers	\$339.00
RR9090HN	900Ø	Hangers	\$389.00

Mirror and Demister Package

Stock Code	Output	RRP \$ Incl.
-	-	-
-	-	-
RR7070HND	24W	\$414.00
RR8080HND	38W	\$486.00
RR9090HND	55W	\$551.00

Mirror thickness from wall: Glue-to-wall - 5mm (Glue not included). Hangers - 14mm (including mirror)
Demister not attached to mirror; supplied as two separate components.





Model shown: AC7510HN/GT

Frameless Mirror Range

Aspen Mirrors

- ☑ Arch shape
- ☑ Polished edge
- ☑ Option for glue-to-wall or hangers
- ☑ Option of with or without a demister



Safety backing film



Portrait mounting only



Copper-free mirror



Two year warranty

Aspen Arch Mirror - Glue-to-Wall

Stock Code	Size W x H (mm)	Fixing Method	RRP \$ Incl.
AC5080GT	500 x 800	Glue-to-Wall	\$279.00
AC7510GT	750 x 1000	Glue-to-Wall	\$389.00

Mirror and Demister Package

Stock Code	Output	RRP \$ Incl.
AC5080GTD	24W	\$404.00
AC7510GTD	60W	\$594.00

Aspen Arch Mirror - Hangers

Stock Code	Size W x H (mm)	Fixing Method	RRP \$ Incl.
AC5080HN	500 x 800	Hangers	\$289.00
AC7510HN	750 x 1000	Hangers	\$399.00

Mirror and Demister Package

Stock Code	Output	RRP \$ Incl.
AC5080HND	24W	\$414.00
AC7510HND	60W	\$604.00

Mirror thickness from wall: Glue-to-wall - 5mm (Glue not included). Hangers - 14mm (including mirror)
Demister not attached to mirror; supplied as two separate components.



Model shown: DP5010GT/HN

Frameless Mirror Range

Duke Mirrors

- ☑ Pill shape
- ☑ Polished edge
- ☑ Option for glue-to-wall or hangers
- ☑ Option of with or without a demister



Safety backing film



Portrait or landscape mounting



Copper-free mirror



Two year warranty

Duke Pill Shape Mirror - Glue-to-Wall

Stock Code	Size (mm)	Fixing Method	RRP \$ Incl.
DP5010GT	500 x 1000	Glue-to-Wall	\$309.00

Mirror and Demister Package

Stock Code	Output	RRP \$ Incl.
DP5010GTD	24W	\$434.00

Duke Pill Shape Mirror - Hangers

Stock Code	Size (mm)	Fixing Method	RRP \$ Incl.
DP5010HN	500 x 1000	Hangers	\$319.00

Mirror and Demister Package

Stock Code	Output	RRP \$ Incl.
DP5010HND	24W	\$444.00

Mirror thickness from wall: Glue-to-wall - 5mm (Glue not included). Hangers - 14mm (including mirror)
Demister not attached to mirror; supplied as two separate components.





Model shown: SS9075HN

Frameless Mirror Range

Sierra Mirrors

- ☑ Rectangle shape
- ☑ Hanger mounting only
- ☑ Option of with or without a demister
- ☑ 25mm sandblasted border with 25mm mirror edge



Safety backing film



Portrait or landscape mounting



Copper-free mirror



Two year warranty

Sierra Sandblasted Border Mirror - Hangers

Stock Code	Size (mm)	Fixing Method	RRP \$ Incl.
SS6075HN	600 x 750	Hangers	\$309.00
SS9075HN	900 x 750	Hangers	\$449.00
SS1280HN	1200 x 800	Hangers	\$629.00
SS1590HN	1500 x 900	Hangers	\$719.00

Mirror and Demister Package

Stock Code	Output	RRP \$ Incl.
SS6075HND	38W	\$456.00
SS9075HND	60W	\$654.00
SS1280HND	100W	\$878.00
SS1590HND	145W	\$994.00

Mirror thickness from wall: Hangers - 14mm (including mirror)
Demister not attached to mirror; supplied as two separate components.



Model shown: C06080HN/GT

Frameless Mirror Range

Cody Mirrors

- ☑ Oval shape
- ☑ Polished edge
- ☑ Option for glue-to-wall or hangers
- ☑ Option of with or without a demister



Safety backing film



Portrait or landscape mounting



Copper-free mirror



Two year warranty

Cody Oval Mirror - Glue-to-Wall

Stock Code	Size (mm)	Fixing Method	RRP \$ Incl.
C06080GT	600 x 800	Glue-to-Wall	\$309.00
C09075GT	900 x 750	Glue-to-Wall	\$399.00

Mirror and Demister Package

Stock Code	Output	RRP \$ Incl.
C06080GTD	24W	\$434.00
C09075GTD	30W	\$548.00

Cody Oval Mirror - Hangers

Stock Code	Size (mm)	Fixing Method	RRP \$ Incl.
C06080HN	600 x 800	Hangers	\$319.00
C09075HN	900 x 750	Hangers	\$409.00

Mirror and Demister Package

Stock Code	Output	RRP \$ Incl.
C06080HND	24W	\$444.00
C09075HND	30W	\$558.00

Mirror thickness from wall: Glue-to-wall - 5mm (Glue not included). Hangers - 14mm (including mirror)
Demister not attached to mirror; supplied as two separate components.





Above Vanity

Model Shown: HD9075HN/HD9075GT



On Side

Model Shown: HD9075HN/HD9075GT



Upside Down

Model Shown: HD1290HN/HD1290GT



On Vanity

Model Shown: HD1511HN/HD1511GT



Model shown: HD1511HN/GT

Frameless Mirror Range

Hamilton Mirrors

- ☑ D shaped
- ☑ Polished edge
- ☑ Option for glue-to-wall or hangers
- ☑ Option of with or without a demister



Safety backing film



Four hanging orientations



Copper-free mirror



Two year warranty

Hamilton D Shape Mirror - Glue-to-Wall

Stock Code	Size (mm)	Fixing Method	RRP \$ Incl.
HD9075GT	900 x 750	Glue-to-Wall	\$429.00
HD1290GT	1200 x 900	Glue-to-Wall	\$649.00
HD1511GT	1500 x 1100	Glue-to-Wall	\$769.00

Mirror and Demister Package

Stock Code	Output	RRP \$ Incl.
HD9075GTD	38W	\$576.00
HD1290GTD	60W	\$854.00
HD1511GTD	100W	\$1,018.00

Hamilton D Shape Mirror - Hangers

Stock Code	Size (mm)	Fixing Method	RRP \$ Incl.
HD9075HN	900 x 750	Hangers	\$459.00
HD1290HN	1200 x 900	Hangers	\$679.00
HD1511HN	1500 x 1100	Hangers	\$799.00

Mirror and Demister Package

Stock Code	Output	RRP \$ Incl.
HD9075HND	38W	\$606.00
HD1290HND	60W	\$884.00
HD1511HND	100W	\$1,048.00

Mirror thickness from wall: Glue-to-wall - 5mm (Glue not included). Hangers - 14mm (including mirror)
Demister not attached to mirror; supplied as two separate components.



**Before
Thermomirror**



**After
Thermomirror**



Thermomirror Demister Pads

Thermomirror is a must for every bathroom. The ultra-thin demister pad provides a clear and condensation-free mirror in any bathroom and is available in a range of practical sizes. Thermomirror is suitable for use with any brand of mirror.

The demister must be applied directly to the back of the mirror. The demister has a self adhesive back for easy application. The demister is designed to warm the mirror slightly to eliminate the difference in temperature between the mirror and the bathroom ensuring it remains fog-free.

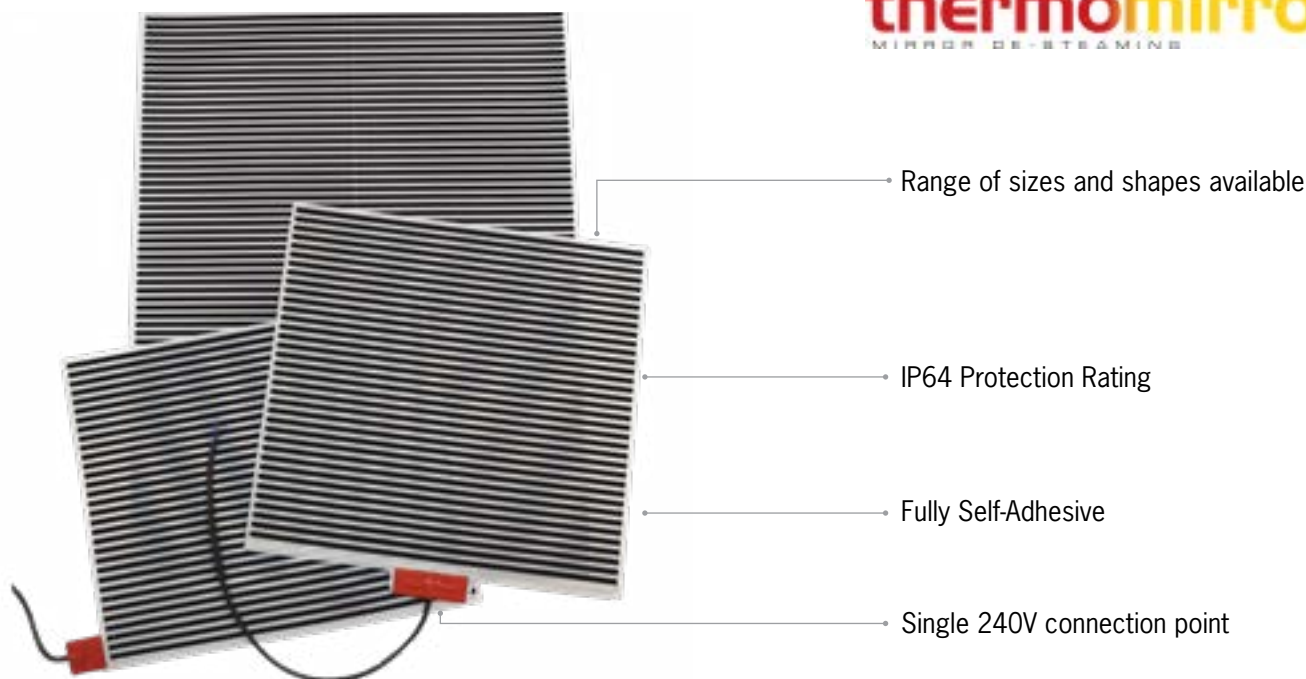

Stock Code	Description	Size L x W (mm)	Heat Output (W)	RRP \$ Incl.
TM2828	Square	280 x 280	16	\$115.00
TM2841	Rectangular	280 x 410	24	\$125.00
TM3545	Rectangular	350 x 450	38	\$147.00
TM4040	Square	400 x 400	30	\$149.00
TM5050	Square	500 x 500	55	\$162.00
TM4170	Rectangular	410 x 700	60	\$205.00
TM5868	Rectangular	580 x 680	80	\$225.00
TM5885	Rectangular	580 x 850	100	\$249.00
TM6010	Rectangular	600 x 1000	145	\$275.00

Thermomirror demisters are available with Ablaze mirrors, refer to pages 135-145.



Ten year warranty



Double insulated



Heating Pad thickness



Safe for use in bathrooms



Thermomirror 12V Demister Pads

Prevent your shower niche from fogging up.

Designed as a low voltage demister pad, these demisters can go in your shower niche, warming the back of the mirror, therefore preventing it from fogging up.

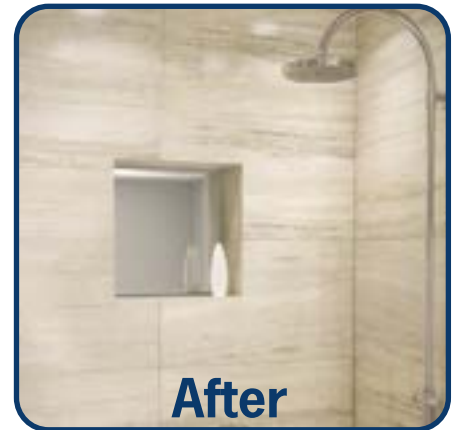

Demister Pack Includes:

- ⦿ 12V Thermomirror Demister Pad (300 x 300mm) with a 5 year warranty
- ⦿ 12V transformer with 12 month warranty
- ⦿ 6mm mirror (400 x 400mm) with a 12 month warranty
- ⦿ Econoboard Coated Insulation Board (H600 x W400 x D6mm)
- ⦿ Neutral cure silicone mirror adhesive

Stock Code	Description	RRP \$ Incl.
5312	12V Demister Pad and Transformer 300 x 300mm (14Watt Output)	\$139.00
5312P	Shower Niche Package - Mirror, 12V Demister Pad, Transformer, Insulation Board and Adhesive	\$429.00



Mirror Cabinet

- ⦿ 400 x 400mm square cabinet
- ⦿ 600mm round mirror door
- ⦿ Adjustable timber shelf
- ⦿ Cannot be recessed into wall
- ⦿ Door hinges left-hand side only
- ⦿ 1 year warranty

The ASCR is not compatible with a mirror demister.

Stock Code	Mirror Size (mm)	Cabinet Size (mm)	RRP \$ Incl.
ASCR	600Ø	400 x 400 x 150	\$629.00

Ablaze Mirror FAQs

We have put together a range of answers to the most frequently asked questions about our Ablaze Mirror Range. If you have a question that isn't answered here please give us a call or scan the QR Code to visit the Thermogroup Learning Centre.



What is best for cleaning mirrors?

For best results clean mirrors with methylated spirits and water at a rate of 30% methylated spirits and 70% water. Do not use Windex or similar chemical cleaning products. Avoid getting water on the sides or back of the mirror as damage to the silver backing can occur. In coastal areas it is recommended to wipe around the edge of the mirror once a month to avoid salt build up that can cause silver creep.

Can I use a back-lit mirror as the only light in my room?

This depends on the size of the mirror and the size of the bathroom. In most situations, normal overhead lighting should be available in addition to the back-lit mirror.

How is the mirror controlled / operated?

The Ablaze magnified mirrors have a switch on the unit. The premium range of back-lit mirrors do not include a switch on the unit, they are designed to be hard-wired into a simple on/off switch. They can also be wired to a motion sensor to be energy efficient and act as a night light.

What is the difference between Cool and Warm light?

Warm lights emit more of a yellowish colour that produces a warm and welcoming atmosphere designed to mimic natural sunlight. Cool lights emit a brighter, white artificial light for a cleaner feel and makes the mirror more functional.

How much does it cost to run my Back-lit mirror?

The LEDs on the back-lit range consume minimal energy and running costs are almost negligible. For example, an average sized mirror (ie.S900C) will cost only one cent per hour to run. (Based on \$0.30 kw/h energy tariff).

What is a copper-free mirror?

A copper-free mirror is made through a chemical sedimentation process as opposed to a traditional silver and copper blend which is highly prone to brown/black edge corrosion. A copper-free mirror has 3 times more resistance to corrosion than traditional mirrors and are a higher quality product. All of Thermogroup Ablaze Backlit, Framed and Frameless mirror ranges are copper-free.

How do I select the correct Thermomirror size?

When selecting a demister, you need to ensure that it is smaller than the size of your mirror. In a glue-to-wall application it is important there is a minimum of 100mm all around the demister to allow for adhesion between the mirror and the wall. For mirrors with hangers, the demister needs to be small enough to ensure that it is out of the way of the screws or mounting brackets. Remember the demister only needs to be where you mainly look and the heat will spread slightly.

How do I operate my demister?

The demister can be connected to the lighting circuit in your bathroom so it operates when your lights are on. Alternatively, it can be connected to its own on/off switch.



Our Product Warranties and Guarantee Information

Thermogroup products are designed to add that little bit extra to your bathroom for years to come. All of our products are covered with warranties that we stand behind and you can trust for peace of mind.

Thermogroup reserves the right to alter designs, product specifications and materials without notice. All measurements are subject to manufacturing tolerances. All prices in this book are Recommended Retail Pricing (RRP) including GST in accordance with the valid price dates. All information is provided on E&OE basis.

Prices valid from 01/03/2023. Subject to change without notice.

©Thermogroup Trading Pty Ltd 2023

Thermogroup ABN | 44 632 780 959

Thermogroup ACN | 632 780 959

Warranty Information

Thermogroup covers all its products with a satisfaction guarantee. In addition, Thermogroup will supply a replacement product where a fault is shown to be caused by faulty manufacture, materials or workmanship providing the goods have been installed correctly & according to the installation instructions. This guarantee does not include removal, freight or installation costs.

Our goods come with guarantees that cannot be excluded under the Australian Consumer Law. You are entitled to a replacement or refund for a major failure and compensation for any other reasonably foreseeable loss or damage. You are also entitled to have the goods repaired or replaced if the goods fail to be of acceptable quality and the failure does not amount to a major failure.

Guarantee Information

All Thermogroup products are covered by the warranty period as stated in this book.

If the product develops a fault within the warranty period due to normal wear and tear, Thermogroup at its discretion will recognise whether it's a faulty product or not. If it is impossible or not economical for the manufacturer to repair the product, the manufacturer will replace the faulty product with a new unit of the same model or if there is no stock available of the same model as the product, the manufacturer will replace the product with a new unit of a similar size. No responsibility can be taken for altered dimensions and lining up of existing holes.

The replacement service offered within the warranty period only covers the faults and problems as developed from the manufacturer's errors. Any damage caused by improper use or carelessness or incorrect installation is not covered. Thermogroup is not responsible for any monetary loss or injuries caused by improper use of the product.

Thermogroup are not held accountable for:

1. Damages or repairs as a result of incorrect installation or application.
2. Damages as a result of floods, fires, winds, lightning, accidents, corrosive atmosphere or any other conditions/situations deemed beyond the control of Thermogroup.
3. Use of incompatible components or accessories.
4. Products installed outside of Australia.
5. Normal maintenance and care procedures as described in the installation guide.
6. Parts not supplied or designated by Thermogroup.
7. Damages or repair required as a direct result of any improper maintenance, operation or servicing.
8. Failure to power up or start as a result of inadequate/interruption of electrical service.
9. Changes in the appearance of the product that do not directly affect the performance of the product.



Underfloor Heating Warranty Lifetime Cable Warranty

The Thermogroup Lifetime Warranty guarantees the Underfloor Heating Cable will remain free from defects in workmanship and materials under normal use and maintenance, and is guaranteed to remain in full working order subject to conditions and limitations.

The cable is guaranteed for the lifetime of the floor covering under which it is originally fitted. Thermogroup Lifetime Warranties applies if:

- The product is registered within 60 days of installation; and
- Only if the heating cable has been properly earthed and protected by a Residual Current Device (RCD) at all times.

All Thermogroup lifetime warranties become void if the floor covering under which the heating cable is originally fitted is damaged, lifted, replaced, repaired or covered with additional layers of flooring.

The Thermogroup Lifetime Warranty does not cover accidental damage, including but not limited to damage caused by lifting, replacing, repairing the original covering laid after installation. The Thermogroup Lifetime Warranty does not cover damage caused during installation, tiling or installation of any floor covering. Therefore, it is important to adhere strictly to the installation guide provided and follow the full test procedure detailed in the installation guide before, during and after installation. Failure to do so will void the product warranty. Thermogroup are, in no event, liable for incidental or consequential damages, including but not limited to extra utility charges or damages to property.



Thermostat Warranty 3 Year Replacement Warranty

The Thermotouch 3 Year Warranty guarantees the Thermotouch Thermostat will remain free from defects in workmanship and materials under normal use and maintenance, and is guaranteed to remain in full working object subject to conditions and limitations.

The Thermotouch 3 Year Warranty does not cover accidental damage, including but not limited to damage caused by installation, removal or cleaning of the unit. Therefore, it is important to adhere strictly to the installation guide provided. Failure to do so will void the product warranty. Thermogroup are, in no event, liable for incidental or consequential damages, including but not limited to extra utility charges or damages to property.



Space Heating Warranty 2 Year Replacement Warranty

Thermofan Fan Heaters are covered by a 2 year replacement warranty where there is a fault caused by manufacture, materials or workmanship providing the goods have been installed correctly and according to installation instructions. The warranty only covers the faults and problems as developed from the manufacturer's errors, and any damage caused by improper use, carelessness or incorrect wiring is not covered. The Thermomat heated carpet mats are covered by a 2 Year replacement warranty. This covers the electrical components but does not warrant against damage caused by wear or tear.



Thermorail Heated Towel Rails Warranty

10 Year Warranty

Standard Thermorail Polished Stainless Steel Rails are covered by a 10 Year replacement warranty. This covers the rail body, finish and the element. This warranty does not apply to the independent 12V transformer (12V models only). This applies to the following products.

- Polished Stainless Steel Single Bar Rails
- Polished Stainless Steel Vertical Rails
- Polished Stainless Steel 12V Ladder Rails
- Polished Stainless Steel Ladder Rails
- Themorad Towel Dryer

7 Year Warranty

Standard Plated/Coloured and Budget Ladder Rails are covered by a 7 Year replacement warranty. This covers the plated finish, the rail body and the element. This warranty does not apply to the independent 12V transformer (12V models only). This applies to the following products.

- Brushed, Black, White, Brushed Gold, Gun Metal, Brushed Brass and Brushed Nickel Single and Vertical Bar Rails
- Black, Brushed, White, Brushed Gold, Gun Metal, Brushed Brass, Brushed Nickel and Rose Gold Ladder Rails
- 240V Budget Ladder Rails
- Free Standing Rails
- Floor-to-Ceiling Rail

5 Year Warranty

All custom plated rails have a 5 Year replacement warranty. This covers the plated finish, the rail body and the element. This applies to the following products.

- Vertical/single Bar Plated Range
- Ladder Plated Range

Transformer Warranty

All Low Voltage (12Volt) rails are supplied with a 12V driver/transformer. This is covered by a 12 Month warranty only.

Timer Warranty

Timer warranty periods differ to the towel rail warranties. Installing a towel rail with or without a timer does not impact the warranty period of the towel rail.

- TRTS, TRTSL, TRTSB are covered by a two-year warranty.
- EB11 is covered by a three-year warranty.
- ET12C, ET12CB & 5289 are covered by a one-year warranty.



Ablaze Mirror Warranty Information

10 Year Warranty

The Thermomirror Demister Pads are covered by a 10 Year replacement warranty.

5 Year Warranty

The Thermomirror 12V Demister Pad in 5312 & 5312P are covered by a 5 Year replacement warranty. This excludes the warranty on the mirror and transformer, these are covered by a 12 month warranty.

3 Year Warranty

The Premium Back-Lit Mirrors are covered by a 3 Year replacement warranty. This covers the mirror and electrical components.

2 Year Warranty

The Frameless Mirrors are covered by a 2 Year replacement warranty.

1 Year Warranty

The Magnifying and Black Frame mirrors are covered by a 1 Year replacement warranty. This covers the mirror and electrical components.

Thermogroup

PO Box 822
LEETON NSW 2705

Phone | 1300 368 631

Technical Line | 1300 989 464

Fax | 1300 655 532

Email | sales@thermogroup.com.au

Web | www.thermogroup.com.au

Prices valid from 01/03/2023. Subject to change without notice.

Thermogroup



That little bit extra...

