

REMER

REMER

As seen on

THE BLOCK

ILLUMINATED MIRROR COLLECTION

REFLECT
REFINEMENT





REMER

COME AND VISIT OUR SELECTION CENTRES.

VICTORIA

13-15 Edison Road
Dandenong South
VIC 3175 Australia
(03) 9706 6663

QUEENSLAND

The Build and Design Centre
66 Merivale St
South Brisbane QLD 4101
(07) 3844 9922

sales@remer.com.au
remer.com.au

#iloveremermirror
@remermirror



*Brilliant mirrors. I love the options like Bluetooth and the Demister, so there's no fogging up while I'm shaving – **Steven***

*Many thanks for getting the shaving cabinet to me so quickly yesterday – greatly appreciated – **Jessica***

*Love your mirrors! They really make it all come together – **Tara***

*High quality mirrors with amazing lighting and features. I couldn't be happier with our Remer Mirrors. Our kids love them! – **Nick***

*Absolutely love our Remer mirrors. Using the Bluetooth is the BEST!!! I was impressed with the sound too – **Tiffany***

*Thank you for your amazing service yesterday and the follow up email. It was so worthwhile visiting the showroom and speaking to you – **Anita***

*I just wanted to thank you so much for your help the other day. Our clients love your products and are super excited to have them in their new home – **Vanessa***

*I ordered a mirror that arrived with a chipped door, and spoke to Jenny at Remer – she was absolutely sensational and sent out a replacement door the next day. Best customer service I've ever received – you'll have me as a customer for life! – **John***

*The quality of these mirrors cannot be overstated. Very happy with how they present in the house and the sound quality is exceptional. Thank you! – **Max***

*I rang about a mirror I was interested in, as I needed measurements and details so my builder and electrician could prepare. Remer provided the necessary details and even emailed photos through, which really helped. Definitely recommended, very helpful and professional. Thanks! – **Daniel***

*The lighting from this cabinet is very good and I depend on that, having not installed above-mirror lighting for this reason. – **Michella***

*The young lady who assisted us was very helpful and knowledgeable. Everyone who sees our mirror is blown away by it – and it certainly adds a lot of light to the tiled wall as well. Great product, great staff, highly recommended – **Kevin***

WHAT THEY'RE SAYING...

SMARTER. CONTEMPORARY. BUILT TO LAST.

REMER
As seen on
THE BLOCK



These elements in unison are the thinking behind every product that we design at Remer. It derives from our philosophy that a space should have the balance of timeless, aesthetic beauty and thoughtful practical design. Every function that Remer mirrors and shaving cabinets offers is designed to maximise the visibility of your grooming space and make your daily routine more efficient.

The story of Remer stems from our mantra “to create and supply innovative and sensible products through exceptional service”. Driven by this vision, Remer has become an industry leader for premium mirrors, delivering the latest mirror trends together with a world-class service. Backed by more than 15 years of experience and technical know-how in producing quality mirrors, Remer brings together design trends with cutting-edge technological innovations to produce a wide range of collections that appeal to a diverse market.

TECHNOLOGY	7
Backlit and Frontlit	8
Dimmable and Adjustable Colour Temperature	10
Demister	12
Bluetooth Speakers	14
Magnifier, Touch Sensor and Infrared Sensor	16
FINISHES	18
PACKAGING	20
LED MIRRORS	22
Arch	24
Eclipse	28
Gatsby	32
Illusion	40
Kara	47
Miro	46
Sphere	54
NON LED MIRRORS	60
Modern	60
LED SHAVING CABINETS	64
Amber	68
Capsule	72
Pearl	74
Vera	76
Warranties and conditions	82









CONTENTS

All prices are Recommended Retail Prices (RRP) including GST. Prices may vary depending on location and are subject to change or correction without notification. All information is provided on a E&OE basis (Errors and Omissions Excepted). There is a huge amount of very useful info in this brochure and there is more than likely an error, big or small, somewhere. Images in this brochure are shown with accessories and other furniture which is not included in the price.



TECHNOLOGY

Remer illuminated mirrors and shaving cabinets are a blend of LED lights and mirrors, combined with modern-day smart technology. We have purposely designed our product lines to be both visually appealing and functional, with features such as LED Lighting, Demisters, Magnifiers and Bluetooth Speakers. Just a simple touch activates these functions, making your daily life a little more convenient and comfortable.

-  LED Lighting
-  Dimmable
-  Adjustable Colour Temperature
-  Demister
-  Bluetooth Speakers
-  Magnifier
-  Touch Sensor
-  Infrared Sensor



BACKLIT



The backlit-designed mirror has light emanating from the back of the mirror towards the entire space, providing aesthetic, ambient lighting to the room. The design allows ambient lighting to seem to illuminate from within the wall, creating a textural wall with layers of depth – especially on a tiled wall.

FRONTLIT



The frontlit style is designed to maximise the direct forward-facing lighting and reduce the overhead shadow typically cast from downlights. With brighter and sharper reflection, it is suitable for performing precision tasks such as makeup application and shaving.

DIMMABLE



ECLIPSE 800DD
[E80DD-MW]



Dimmable technology allows you to adjust the lighting level to your preference. Start your day energised with full brightness, then relax and wind down in the evening with more subdued ambiance – or choose anything in between.

ADJUSTABLE COLOUR TEMPERATURE



KARA 120DB
[K120750DB]

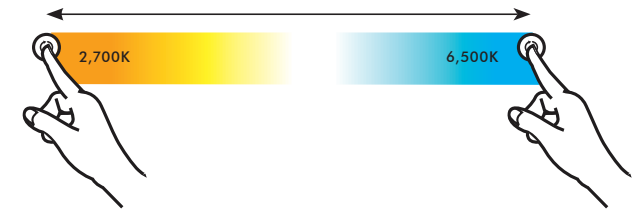

With the ability to change the light colour from warm to cool, you are able to mimic the lighting of any occasion that you are attending, and apply makeup accordingly.

DEMISTER

One of the more luxurious features of Remer mirrors and shaving cabinets is the inclusion of the Demister. The demister functionality allows you to have steamy showers without compromising the quality and care of your mirror. You'll be able to bask in the heat of your bathroom – a luxury on cold winter mornings – while still having a clean, clear mirror to do your morning skincare routine. With more time saved in the morning not having to wipe down your mirror, and the added comfort of having a warm bathroom during your mornings, the Remer mirror and shaving cabinet collections add convenience to your day-to-day routine that was previously not possible. Simply switch this function on via the Touch Sensor before your shower to keep it fog-free. Every single detail has been considered in the making of your Remer product.



Demister with Auto Cut-off*

**Auto Cut-off feature does not apply to Illusion, Modern Collections and all shaving cabinets.*

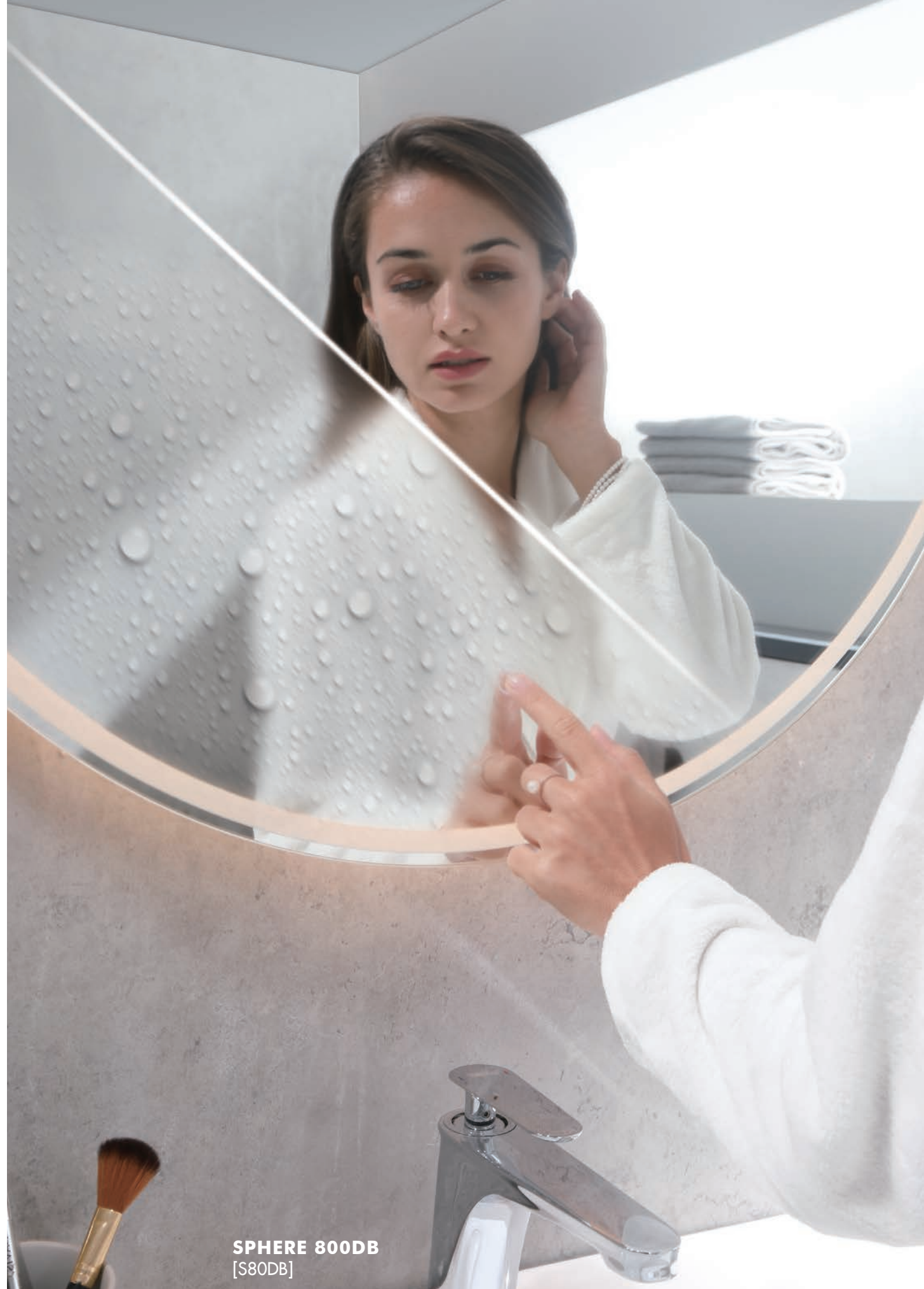

SPHERE 800DB
[S80DB]



SPHERE 800DB
[S80DB]

BLUETOOTH SPEAKERS

Enhance your bathroom experience with sound. Choose the playlist that sets the mood for the day and connect straight from your phone to the Bluetooth mirror. The in-built speakers project the sound to surround your entire bathroom space. Create a space that is entirely yours.



MAGNIFIER

Precision creates perfection. Magnify your face to effortlessly groom and apply makeup. With a ring of light that surrounds the built-in Magnifier, you'll have no more overhead shadows.



TOUCH SENSOR

Technologies are controlled via a simple touch.

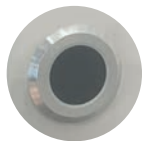

INFRARED SENSOR

Touchless infrared sensor to activate lighting and control the colour temperature.



MIRO 1200DM
[M120DM]



ALUMINIUM FRAMES

ALUMINIUM FRAMES

Create the mirror of your dreams with Remer's custom-made aluminium frames. Mix and match from our selection of classic shapes, elegant colours and wide range of sizes to pair perfectly with your tapware, cabinetry and decor, then add in advanced functionality to make your bathroom experience seamless every time.

FINISHES

REMER

As seen on

THE BLOCK

CONCRETE FRAMES

- Exclusive to our Sphere and Modern Moon collections.
- Six earthy colours to choose from.
- Beautifully finished texture and style.
- Locally crafted frames from ethically sourced materials.

Artisan-crafted in Australia, these sophisticated frames bring perfect minimalist elegance to your home. The ripples and swirls of setting concrete are unique to each piece, creating a bold and functional artwork that can be showcased as a decorative accent or paired with tapware and cabinetry to lend any space timeless luxury. Mix and match a huge range of options to create your perfect mirror—choose from six chic colours, LED lighting, demister, speakers, and the latest sizes and shapes.

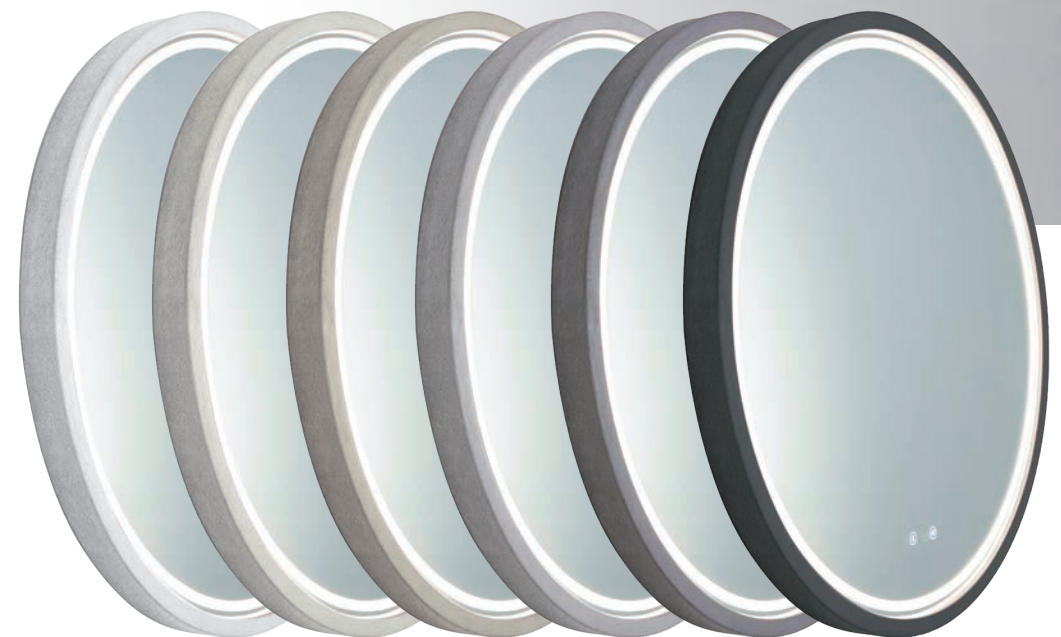

CONCRETE FRAMES



PACKAGING

The packaging in which you receive your Remer product is just as innovative as the product itself. With an effective use of materials, the glass and electronic components are well-cushioned against pressure during transportation.

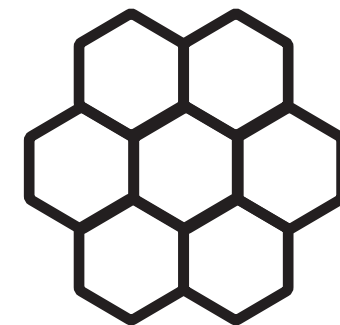

HONEYCOMB STRUCTURE

We utilise quality honeycomb board to transport most of our products, which provides compression, strength and rigidity to the packaging. Along with intelligent packaging design, we reduce our carbon footprint while ensuring your product is intact.

LED MIRRORS

State-of-the-art design and technology.

**SPHERE 800DB WITH BRUSHED
BRASS ALUMINIUM FRAME**
[S80DB-BB]



ARCH



FEATURES	ARCH D	GREAT GREAT ARCH
Copper Free Mirror	●	●
LED Lighting (Adjustable Colour Temperature)	●	●
Demister with 1 Hour Auto Cut-off	●	
Infrared Sensor		●
Touch Sensor	●	
AVAILABLE SIZE (mm)		
500 x 900	✓	
600 x 1800		✓

LIGHTING SPECIFICATIONS

CCT: 2700K - 6500K
CRI: >80

INSTALLATION

Wall mount
Hardwire
Input voltage: 220-240v 50Hz

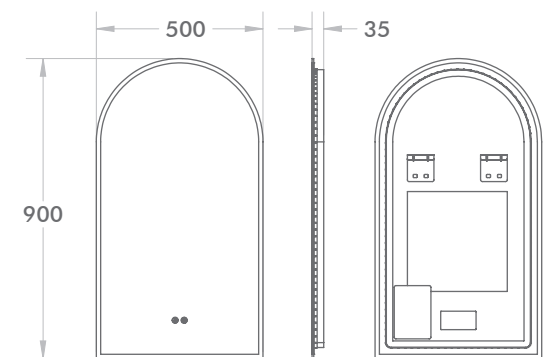

Size: 900(H)

ARCH 500D [AR50D]

Size: 500×900×35mm
LED Lighting (Adjustable Colour Temperature)
Backlit
Demister with 1 Hour Auto Cut-off

RRP: \$579

WITH COLOURED ALUMINIUM FRAME

Size: 510×910×40mm
LED Lighting (Adjustable Colour Temperature)
Frontlit
Demister with 1 Hour Auto Cut-off

Matt Black [AR50D-MB]
Gun Metal [AR50D-GM]
Brushed Nickel [AR50D-BN]
Rose Gold [AR50D-RG]
Brushed Brass [AR50D-BB]

RRP: \$729

Note:

- Coloured aluminium frame made-to-order: please allow 5 business days for dispatch.
- Actual colours may vary so please check color samples before ordering.
- Made-to-order cannot be cancelled, altered, exchanged or refunded unless faulty or damaged.

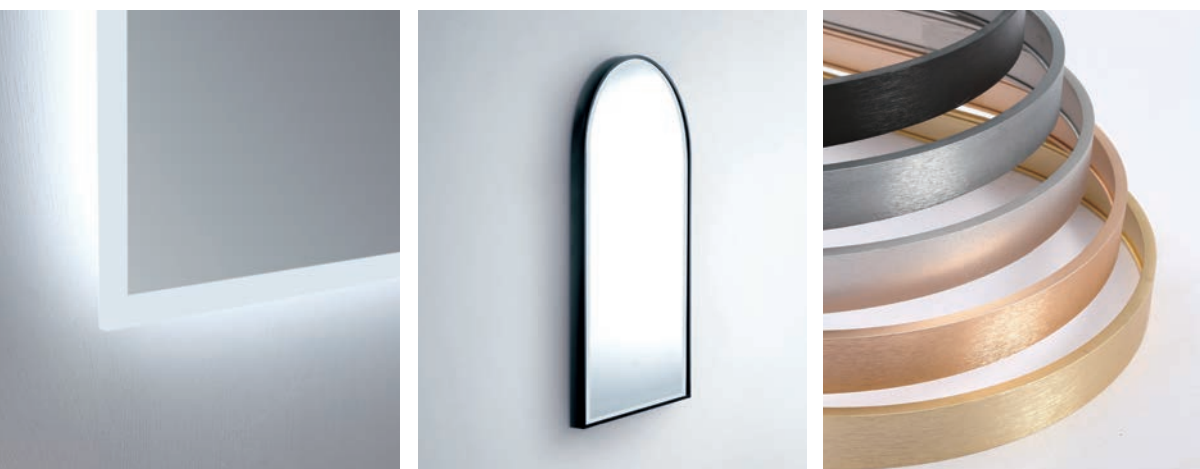



Size: 1800(H)

**GREAT GREAT ARCH 600
MATT WHITE**
[GGAR60-MW]

Size: 600×1800×30mm
LED Lighting (Adjustable Colour Temperature)
Frontlit
Infrared Sensor
Matt White Aluminium Frame

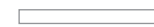

RRP: \$849

**GREAT GREAT ARCH 600
MATT BLACK**
[GGAR60-MB]

Size: 600×1800×30mm
LED Lighting (Adjustable Colour Temperature)
Frontlit
Infrared Sensor
Matt Black Aluminium Frame



RRP: \$849

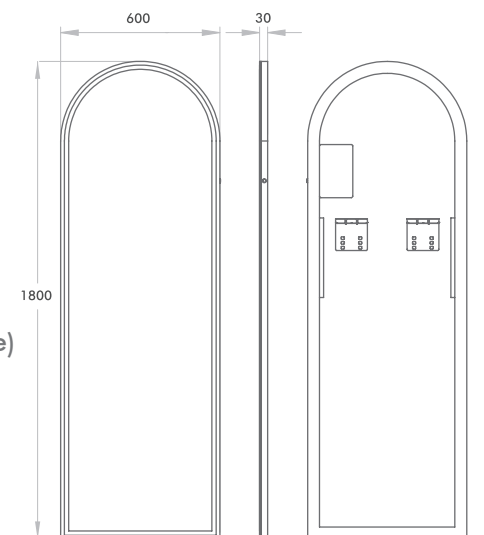

ECLIPSE



FEATURES	ECLIPSE D	ECLIPSE DD
Copper Free Mirror	•	•
LED Lighting (Adjustable Colour Temperature)	•	•
Dimmable		•
Demister with 1 Hour Auto Cut-off	•	•
Touch Sensor	•	•
AVAILABLE SIZE (mm)		
600 x 600	✓	✓
800 x 800	✓	✓

LIGHTING SPECIFICATIONS

CCT: 2700K - 6500K
CRI: >80

INSTALLATION

Wall mount
Hardwire
Input voltage: 220-240v 50Hz

MDF FRAME OPTIONS

Matt Black 
Matt White 

Refer to page 30-31 for more information

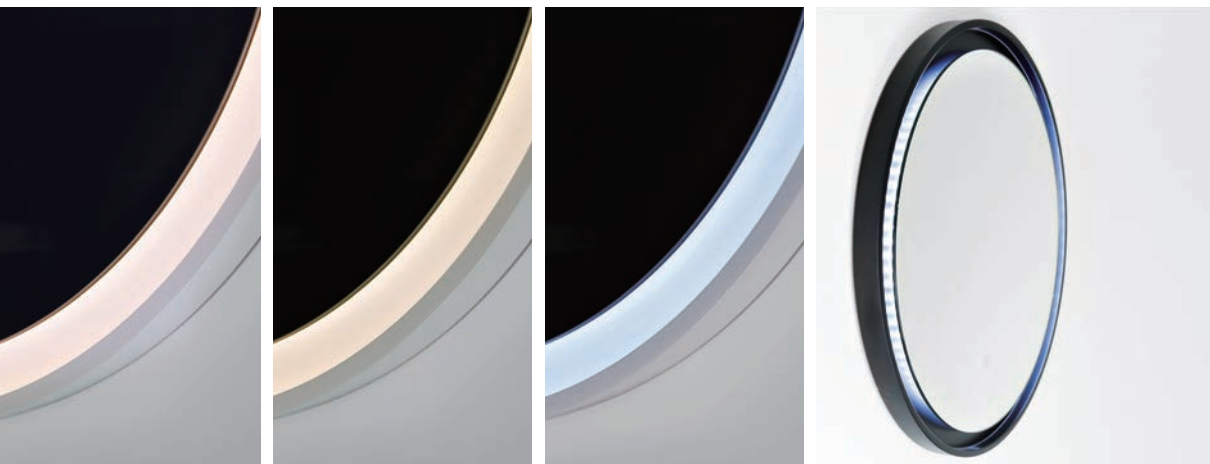

ECLIPSE 600D
[E60D-MW]

Size: 600

Size: 600×600×33mm
LED Lighting (Adjustable Colour Temperature)
Frontlit
Demister with 1 Hour Auto Cut-off
MDF Frame: Matt White

RRP: \$849

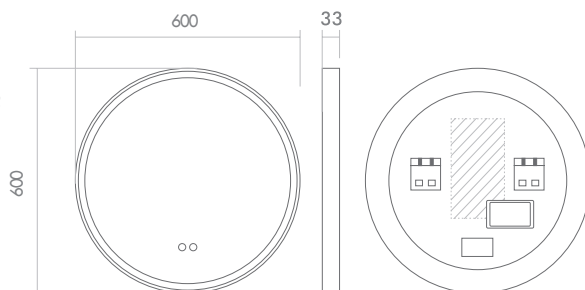

ECLIPSE 600D
[E60D-MB]

Size: 600

Size: 600×600×33mm
LED Lighting (Adjustable Colour Temperature)
Frontlit
Demister with 1 Hour Auto Cut-off
MDF Frame: Matt Black

RRP: \$849

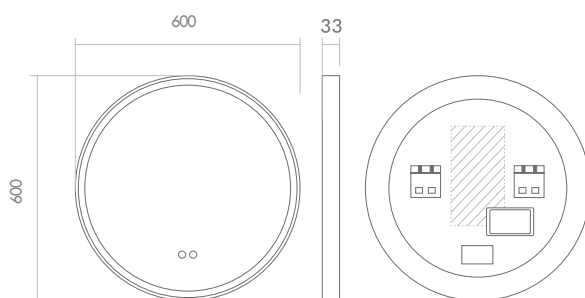

ECLIPSE 600DD
[E60DD-MW]

Size: 600

Size: 600×600×33mm
LED Lighting (Adjustable Colour Temperature)
Frontlit
Dimmable
Demister with 1 Hour Auto Cut-off
MDF Frame: Matt White

RRP: \$969

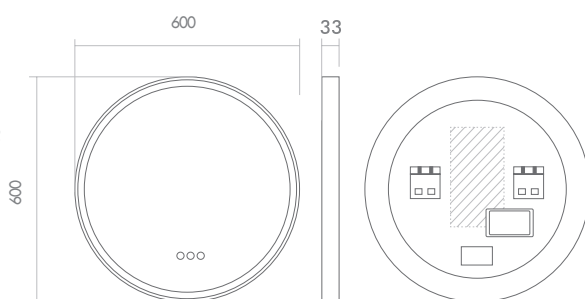

ECLIPSE 600DD
[E60DD-MB]

Size: 600

Size: 600×600×33mm
LED Lighting (Adjustable Colour Temperature)
Frontlit
Dimmable
Demister with 1 Hour Auto Cut-off
MDF Frame: Matt Black

RRP: \$969

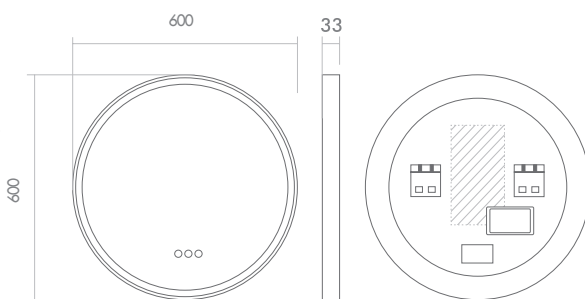

ECLIPSE 800D
[E80D-MW]

Size: 800

Size: 800×800×33mm
LED Lighting (Adjustable Colour Temperature)
Frontlit
Demister with 1 Hour Auto Cut-off
MDF Frame: Matt White

RRP: \$969

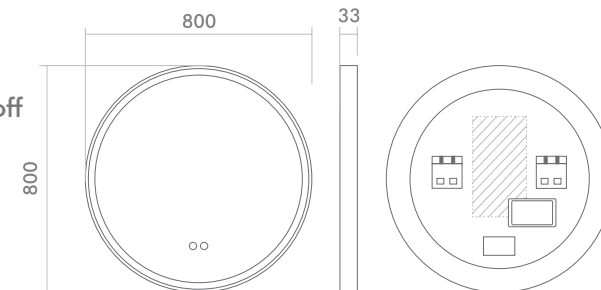

ECLIPSE 800D
[E80D-MB]

Size: 800

Size: 800×800×33mm
LED Lighting (Adjustable Colour Temperature)
Frontlit
Demister with 1 Hour Auto Cut-off
MDF Frame: Matt Black

RRP: \$969

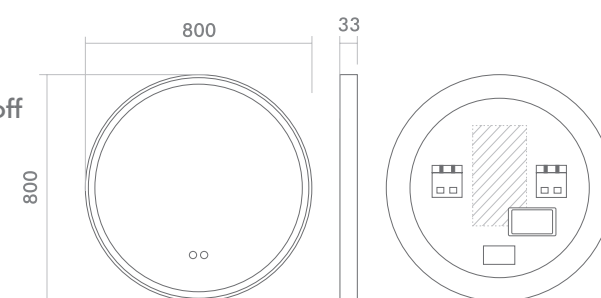

ECLIPSE 800DD
[E80DD-MW]

Size: 800

Size: 800×800×33mm
LED Lighting (Adjustable Colour Temperature)
Frontlit
Dimmable
Demister with 1 Hour Auto Cut-off
MDF Frame: Matt White

RRP: \$1079

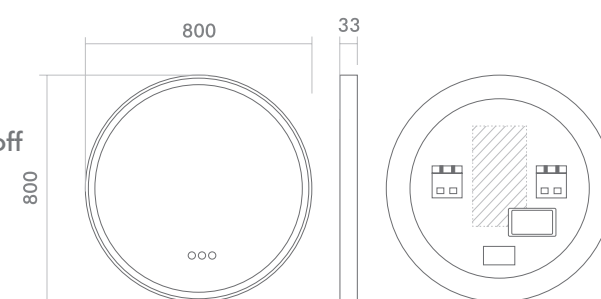

ECLIPSE 800DD
[E80DD-MB]

Size: 800

Size: 800×800×33mm
LED Lighting (Adjustable Colour Temperature)
Frontlit
Dimmable
Demister with 1 Hour Auto Cut-off
MDF Frame: Matt Black

RRP: \$1079

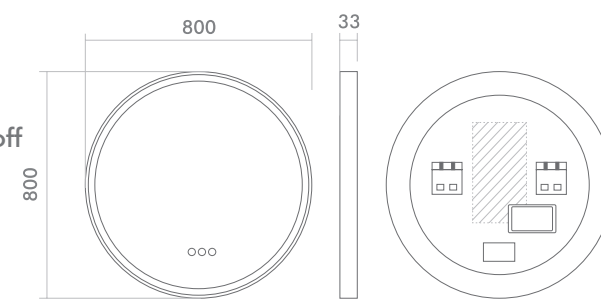

REMER

As seen on

THE BLOCK

GREAT GREAT GATSBY

With Matt Black Aluminium Frame
[GGG60-MB]



GATSBY

REMER

As seen on

THE BLOCK

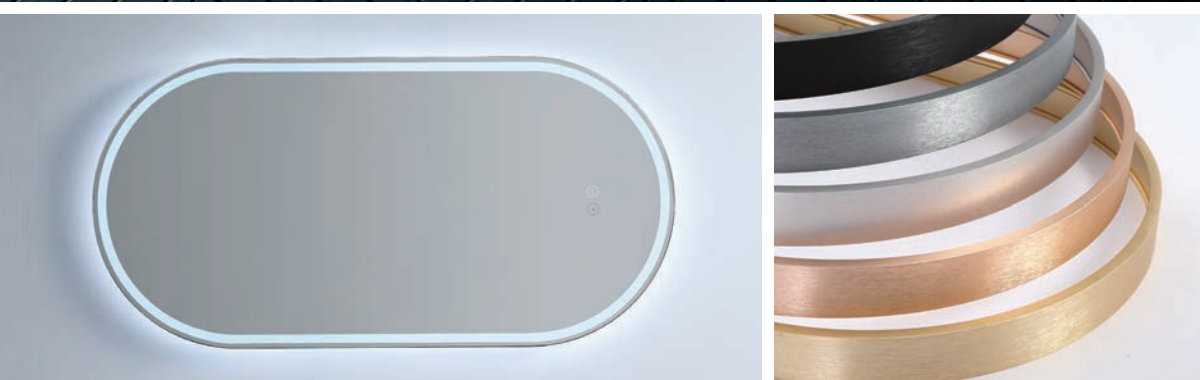

FEATURES	GATSBY	GREAT GATSBY	GREAT GREAT GATSBY
Copper Free Mirror	•	•	•
LED Lighting (Adjustable Colour Temperature)	•	•	•
Demister with 1 Hour Auto Cut-off	•	•	
Infrared Sensor			•
Touch Sensor	•	•	
AVAILABLE SIZE (mm)			
450 x 900	✓		
450 x 1200		✓	
600 x 1800			✓

LIGHTING SPECIFICATIONS

CCT: 2700K - 6500K

CRI: >80

INSTALLATION





Wall mount

Hardwire

Input voltage: 220-240v 50Hz

OPTIONAL EXTRA

COLOURED ALUMINIUM FRAMES

Matt Black	
Gun Metal	
Brushed Nickel	
Rose Gold	
Brushed Brass	

Refer to page 36-39 for more information

Note:

- Coloured aluminium frame made-to-order: please allow 5 business days for dispatch.
- Actual colours may vary so please check color samples before ordering.
- Made-to-order cannot be cancelled, altered, exchanged or refunded unless faulty or damaged.



Size: 900(H)

GATSBY 450X900D
[G4590D]



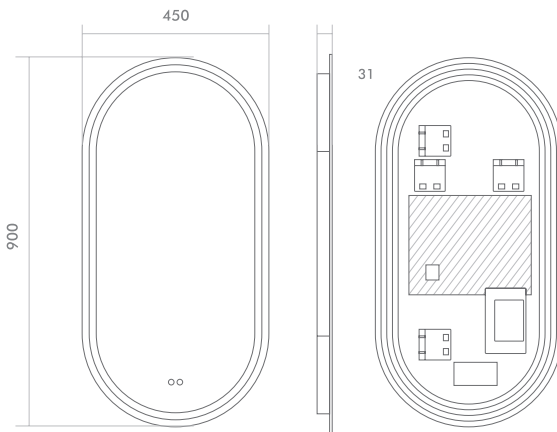

Size: 450x900x31mm
LED Lighting (Adjustable Colour Temperature)
Backlit
Demister with 1 Hour Auto Cut-off

RRP: \$739



WITH COLOURED ALUMINIUM FRAME

Size: 460x910x40mm
LED Lighting (Adjustable Colour Temperature)
Frontlit
Demister with 1 Hour Auto Cut-off

- Matt Black  [G4590D-MB]
- Gun Metal  [G4590D-GM]
- Brushed Nickel  [G4590D-BN]
- Rose Gold  [G4590D-RG]
- Brushed Brass  [G4590D-BB]

RRP: \$969



Size: 1200(H)

GREAT GATSBY 450X1200D
[GG45120D]



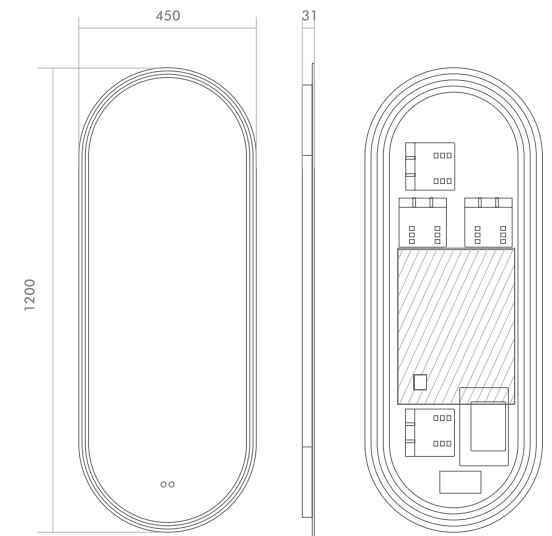

Size: 450x1200x31mm
LED Lighting (Adjustable Colour Temperature)
Backlit
Demister with 1 Hour Auto Cut-off

RRP: \$919

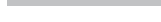

WITH COLOURED ALUMINIUM FRAME

Size: 460x1210x40mm
LED Lighting (Adjustable Colour Temperature)
Frontlit
Demister with 1 Hour Auto Cut-off

- Matt Black  [GG45120D-MB]
- Gun Metal  [GG45120D-GM]
- Brushed Nickel  [GG45120D-BN]
- Rose Gold  [GG45120D-RG]
- Brushed Brass  [GG45120D-BB]

RRP: \$1189

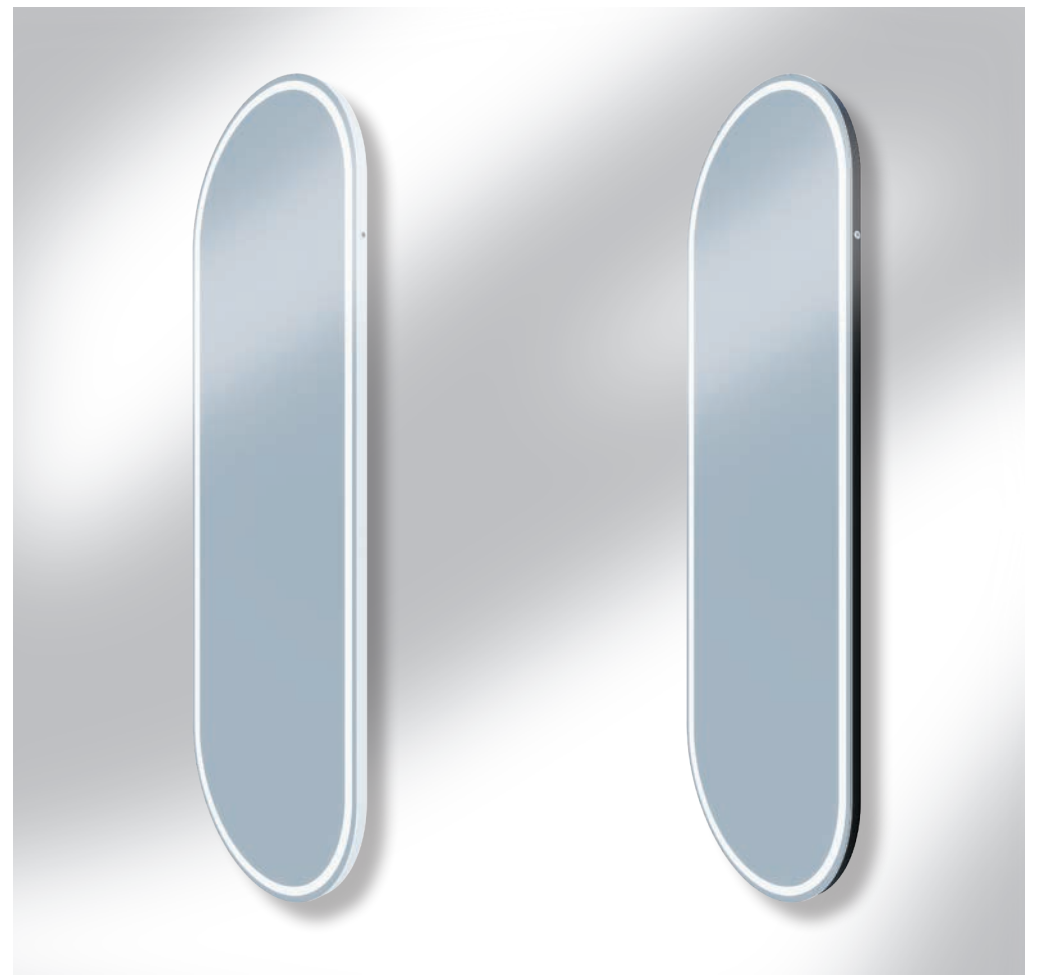

Size: 1800(H)

**GREAT GREAT GATSBY
600X1800 MATT WHITE
[GGG60-MW]**

Size: 600x1800x30mm
LED Lighting (Adjustable Colour
Temperature)
Frontlit
Infrared Sensor
Matt White Aluminium Frame



RRP: \$849

**GREAT GREAT GATSBY
600X1800 MATT BLACK
[GGG60-MB]**

Size: 600x1800x30mm
LED Lighting (Adjustable Colour
Temperature)
Frontlit
Infrared Sensor
Matt Black Aluminium Frame



RRP: \$849

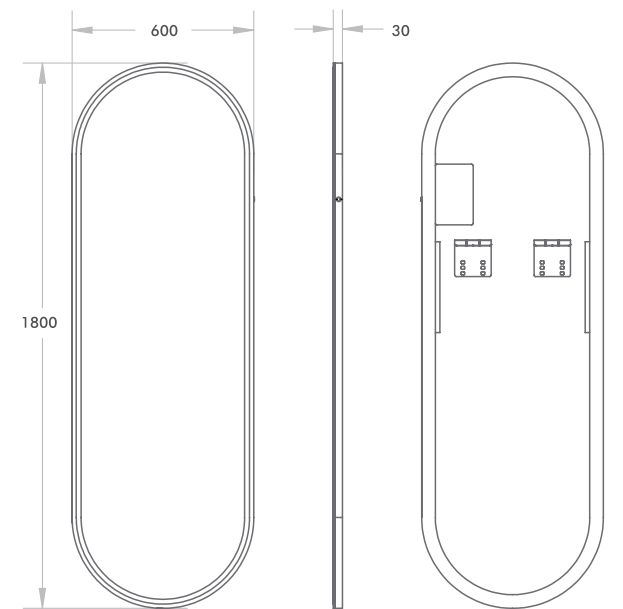

Sizes are in mm and nominal and should be checked prior to installation.
All LED Products requiring hardwiring must be installed by a licensed electrician in accordance with local regulations.

ILLUSION



FEATURES	ILLUSION
Copper Free Mirror	•
LED Lighting (Adjustable Colour Temperature)	•
Demister	•
X5 Magnifier	•
Adjustable Swivel Arms	•
Maximum Reach: 400mm	•
Touch Sensor	•
AVAILABLE SIZE (mm)	
203 x 203 x 24 mm	✓

LIGHTING SPECIFICATIONS

CCT: 6500K - daylight
CRI: >80

INSTALLATION

Wall mount
Hardwire
Input voltage: 220-240v 50Hz

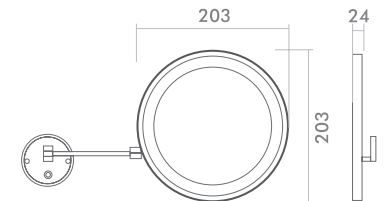

ILLUSION CHROME [ID-X5-C]

Size: 203x203x24mm
Frontlit
Chrome

RRP: \$459

ILLUSION MATT BLACK [ID-X5-MB]

Size: 203x203x24mm
Frontlit
Matt Black

RRP: \$459

Sizes are in mm and nominal and should be checked prior to installation.
All LED Products requiring hardwiring must be installed by a licensed electrician in accordance with local regulations.



KARA

REMER
As seen on
THE BLOCK



FEATURES	KARA D	KARA DB
Copper Free Mirror	•	•
LED Lighting (Adjustable Colour Temperature)	•	•
Demister with 1 Hour Auto Cut-off	•	•
Bluetooth Speakers		•
Acrylic Frame	•	•
Touch Sensor	•	•
AVAILABLE SIZE (mm)		
900 x 600	✓	✓
1200 x 750	✓	✓

LIGHTING SPECIFICATIONS

CCT: 2700K - 6500K
CRI: >80

INSTALLATION

Wall mount
Hardwire
Input voltage: 220-240v 50Hz

Refer to page 44-45 for more information

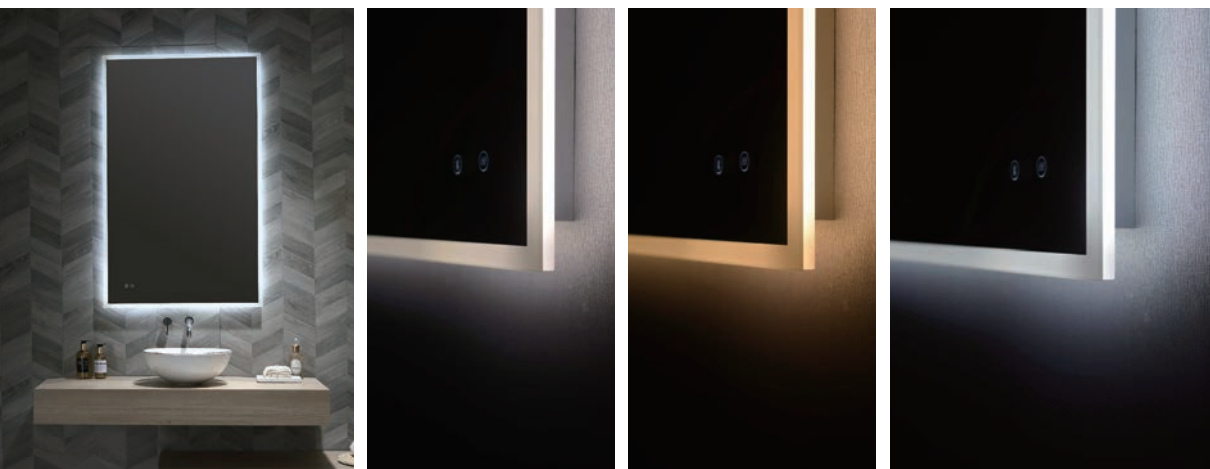

KARA 900D
[K9060D]

Size: 900

Size: 900×600×40mm
LED Lighting (Adjustable Colour Temperature)
Backlit
Demister with 1 Hour Auto Cut-off

RRP: \$979

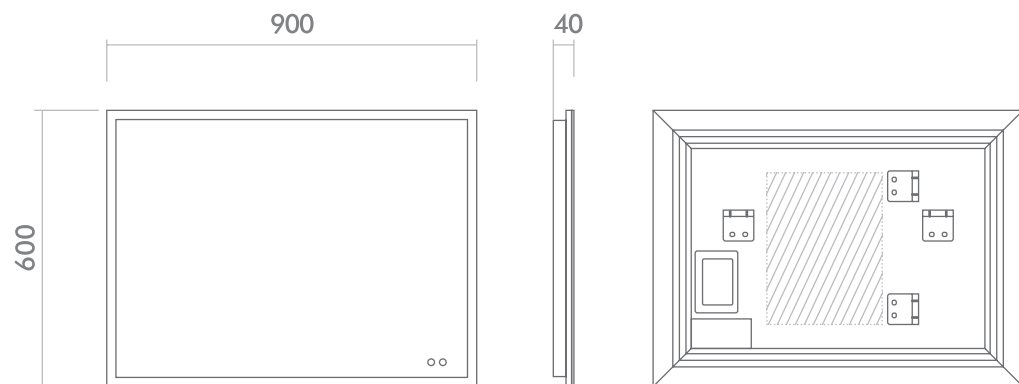

KARA 1200D
[K12075D]

Size: 1200

Size: 1200×750×40mm
LED Lighting (Adjustable Colour Temperature)
Backlit
Demister with 1 Hour Auto Cut-off

RRP: \$1209

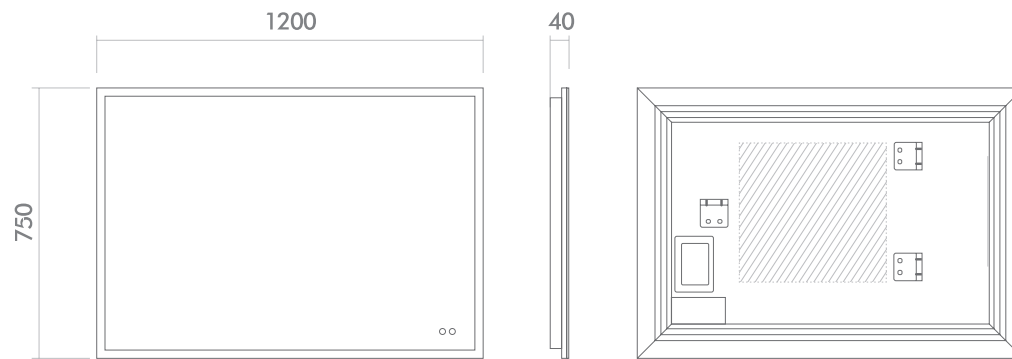

KARA 900DB
[K9060DB]

Size: 900

Size: 900×600×59mm
LED Lighting (Adjustable Colour Temperature)
Backlit
Demister with 1 Hour Auto Cut-off
Bluetooth Speakers

RRP: \$1329

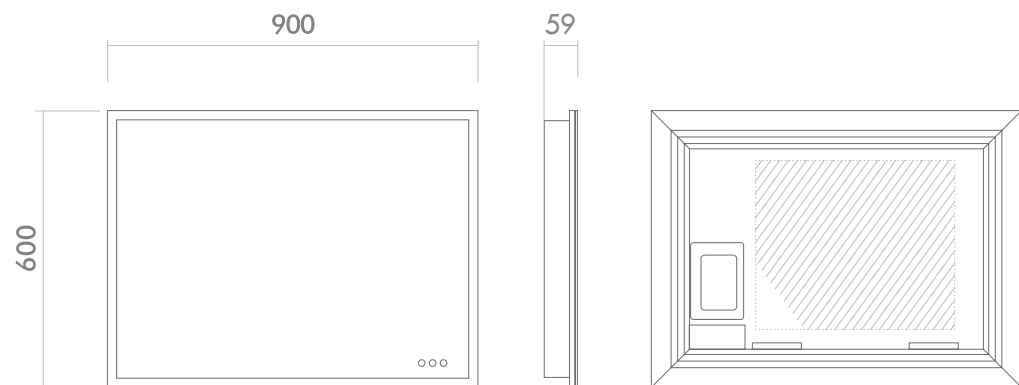

KARA 1200DB
[K12075DB]

Size: 1200

Size: 1200×750×59mm
LED Lighting (Adjustable Colour Temperature)
Backlit
Demister with 1 Hour Auto Cut-off
Bluetooth Speakers

RRP: \$1519

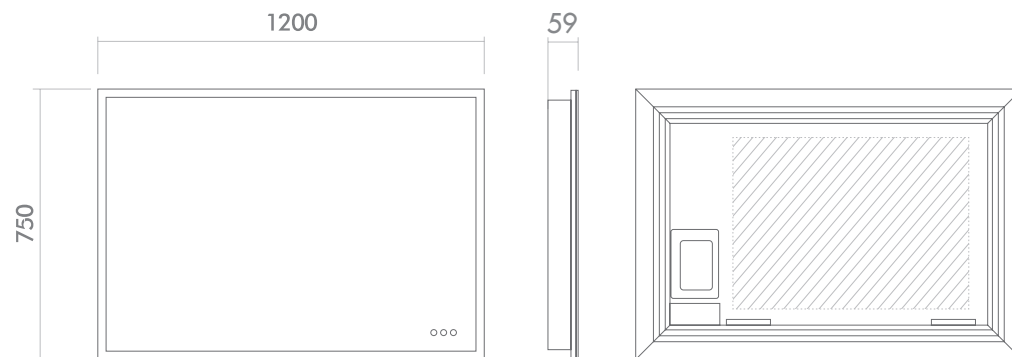

MIRO

MIRO 1200D
[M120D]

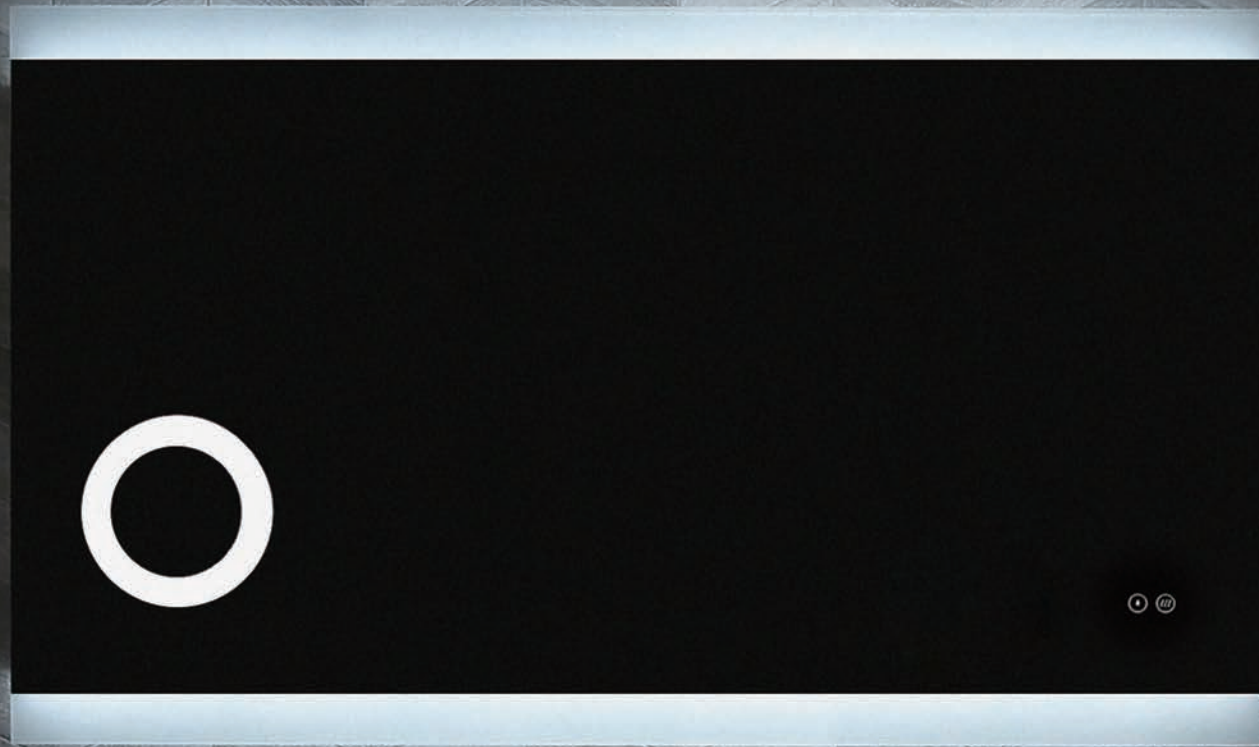

MIRO



FEATURES	MIRO D	MIRO DM	MIRO DB
Copper Free Mirror	•	•	•
LED Lighting (Adjustable Colour Temperature)	•	•	•
Demister with 1 Hour Auto Cut-off	•	•	•
Bluetooth Speakers			•
3X Magnifier		•	
Touch Sensor	•	•	•
AVAILABLE SIZE (mm)			
750 x 900	✓		✓
900 x 700	✓		✓
1200 x 700	✓	✓	✓
1500 x 750	✓	✓	✓
1800 x 850	✓	✓	✓

LIGHTING SPECIFICATIONS

CCT: 2700K - 6500K
CRI: >80

INSTALLATION

Wall mount
Hardwire
Input voltage: 220-240v 50Hz

Refer to page 50-53 for more information

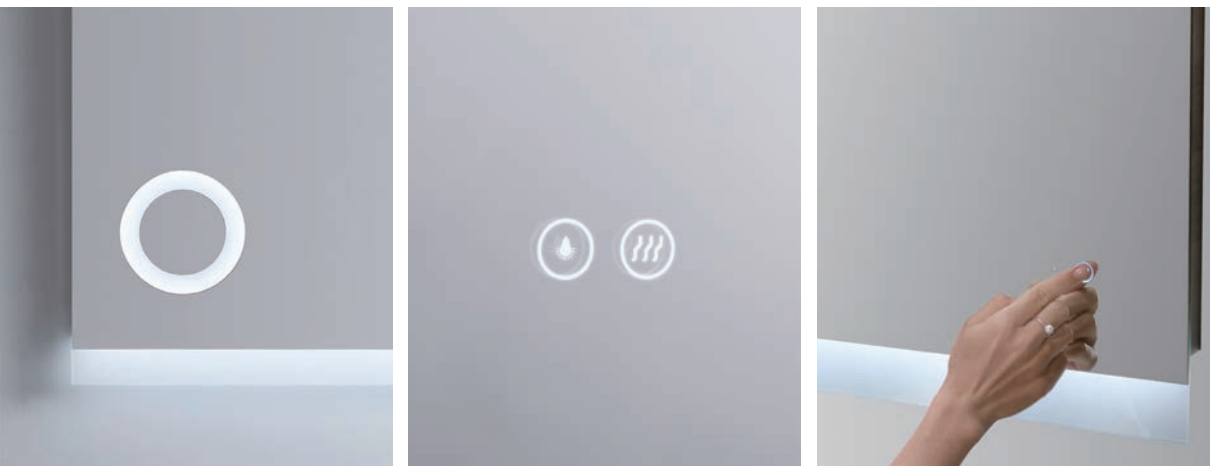

MIRO 750D
[M75D]

Size: 750×900×30mm
LED Lighting (Adjustable Colour Temperature)
Backlit
Demister with 1 Hour Auto Cut-off

RRP: \$689

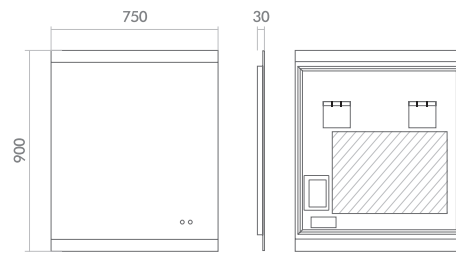

Size: 750

MIRO 750DB
[M75DB]

Size: 750×900×59mm
LED Lighting (Adjustable Colour Temperature)
Backlit
Demister with 1 Hour Auto Cut-off
Bluetooth Speakers

RRP: \$869

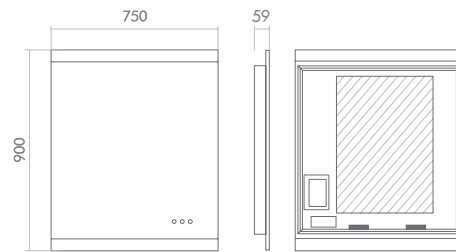

Size: 750

MIRO 900D
[M90D]

Size: 900×700×30mm
LED Lighting (Adjustable Colour Temperature)
Backlit
Demister with 1 Hour Auto Cut-off

RRP: \$759

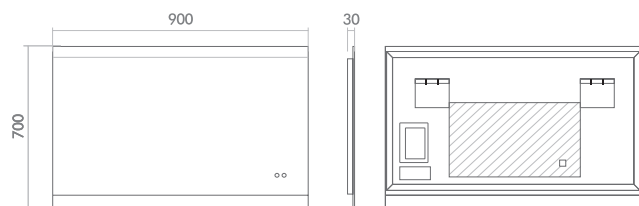

Size: 900

MIRO 900DB
[M90DB]

Size: 900×700×59 mm
LED Lighting (Adjustable Colour Temperature)
Backlit
Demister with 1 Hour Auto Cut-off
Bluetooth Speakers

RRP: \$919

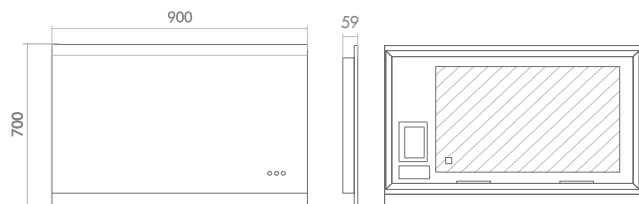

Size: 900

MIRO 1200D
[M120D]

Size: 1200×700×40mm
LED Lighting (Adjustable Colour Temperature)
Backlit
Demister with 1 Hour Auto Cut-off

RRP: \$809

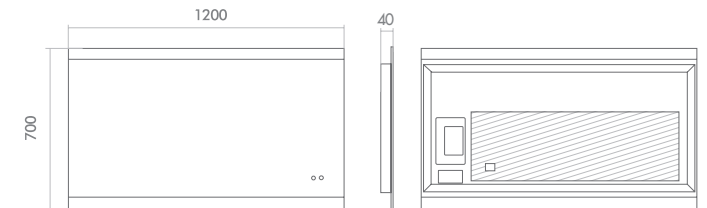

Size: 1200

MIRO 1200DM
[M120DM]

Size: 1200×700×50mm
LED Lighting (Adjustable Colour Temperature)
Backlit
Demister with 1 Hour Auto Cut-off
3X Magnifier

RRP: \$919

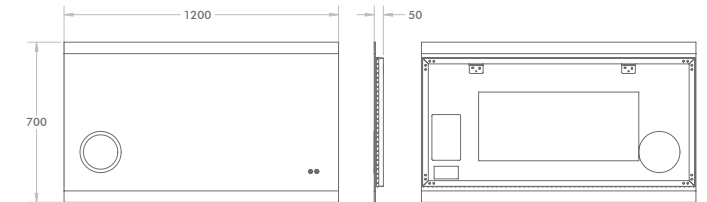

Size: 1200

MIRO 1200DB
[M120DB]

Size: 1200×700×59mm
LED Lighting (Adjustable Colour Temperature)
Backlit
Demister with 1 Hour Auto Cut-off
Bluetooth Speakers

RRP: \$1149

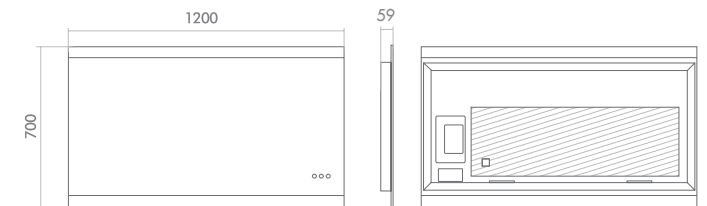

Size: 1200

MIRO 1500D
[M150D]

Size: 1500

Size: 1500×750×40mm
LED Lighting (Adjustable Colour Temperature)
Backlit
Demister with 1 Hour Auto Cut-off

RRP: \$1149

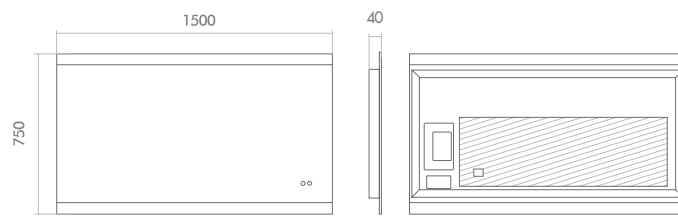

MIRO 1800D
[M180D]

Size: 1800

Size: 1800×850×40mm
LED Lighting (Adjustable Colour Temperature)
Backlit
Demister with 1 Hour Auto Cut-off

RRP: \$1439

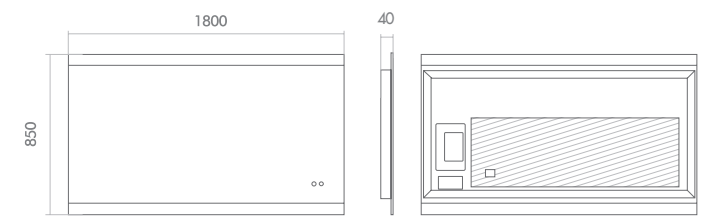

MIRO 1500DM
[M150DM]

Size: 1500

Size: 1500×750×50mm
LED Lighting (Adjustable Colour Temperature)
Backlit
Demister with 1 Hour Auto Cut-off
3X Magnifier

RRP: \$1269

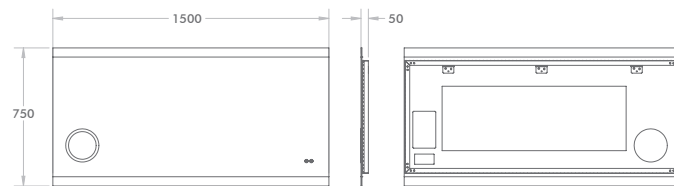

MIRO 1800DM
[M180DM]

Size: 1800

Size: 1800×850×50mm
LED Lighting (Adjustable Colour Temperature)
Backlit
Demister with 1 Hour Auto Cut-off
3X Magnifier

RRP: \$1559

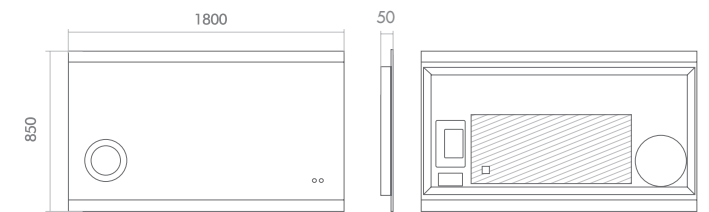

MIRO 1500DB
[M150DB]

Size: 1500

Size: 1500×750×59mm
LED Lighting (Adjustable Colour Temperature)
Backlit
Demister with 1 Hour Auto Cut-off
Bluetooth Speakers

RRP: \$1479

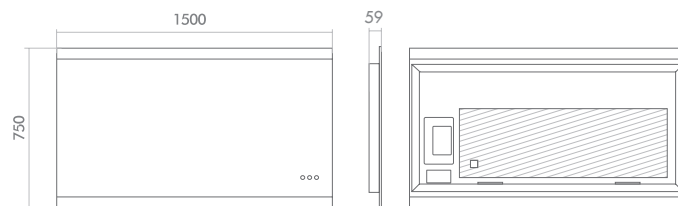

MIRO 1800DB
[M180DB]

Size: 1800

Size: 1800×850×50mm
LED Lighting (Adjustable Colour Temperature)
Backlit
Demister with 1 Hour Auto Cut-off
Bluetooth Speakers

RRP: \$1729

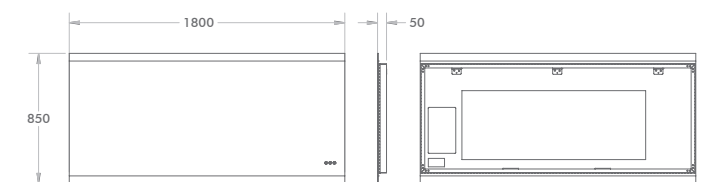



SPHERE

SPHERE 800DB
[S80DB]

SPHERE



FEATURES	SPHERE	SPHERE D	SPHERE DB
Copper Free Mirror	●	●	●
LED Lighting (Adjustable Colour Temperature)	●	●	●
Demister with 1 Hour Auto Cut-off		●	●
Bluetooth Speakers			●
Touch Sensor	●	●	●
AVAILABLE SIZE (mm)			
600 x 600	✓	✓	✓
800 x 800	✓	✓	✓

LIGHTING SPECIFICATIONS

CCT: 2700K - 6500K

CRI: >80

INSTALLATION

Wall mount

Hardwire

Input voltage: 220-240v 50Hz

OPTIONAL EXTRA

COLOURED ALUMINIUM FRAMES

Matt Black



Gun Metal



Brushed Nickel



Rose Gold



Brushed Brass



COLOURED CONCRETE FRAMES

Ash



Desert



Nickel



Stone



Taupe



Coal



Refer to page 60-61 for more information



Note:

- Coloured aluminium frame made-to-order: please allow 5 business days for dispatch.
- Coloured concrete frame made-to-order: please allow 8 weeks for dispatch.
- Actual colours may vary so please check color samples before ordering.
- Made-to-order cannot be cancelled, altered, exchanged or refunded unless faulty or damaged.

SPHERE 600

[S60]

Size: 600×600×35mm
LED Lighting (Adjustable Colour Temperature)
Backlit

RRP: \$549

WITH COLOURED ALUMINIUM FRAME

Size: 610×610×40mm
Frontlit

Matt Black		[S60-MB]
Gun Metal		[S60-GM]
Brushed Nickel		[S60-BN]
Rose Gold		[S60-RG]
Brushed Brass		[S60-BB]

RRP: \$689

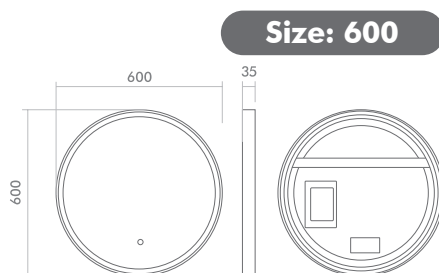

Size: 600

WITH COLOURED CONCRETE FRAME

Size: 660×660×50mm | Approx weight: 18kg
Frontlit

Ash		[S60-CA]
Desert		[S60-CD]
Nickel		[S60-CN]
Stone		[S60-CS]
Taupe		[S60-CT]
Coal		[S60-CC]

RRP: \$1609

SPHERE 800

[S80]

Size: 800×800×35mm
LED Lighting (Adjustable Colour Temperature)
Backlit

RRP: \$739

WITH COLOURED ALUMINIUM FRAME

Size: 810×810×40mm
Frontlit

Matt Black		[S80-MB]
Gun Metal		[S80-GM]
Brushed Nickel		[S80-BN]
Rose Gold		[S80-RG]
Brushed Brass		[S80-BB]

RRP: \$949

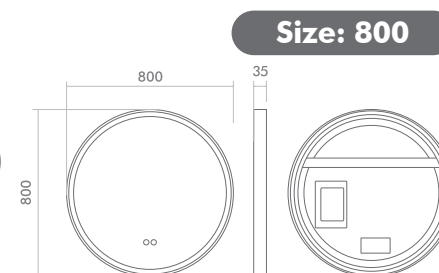

Size: 800

WITH COLOURED CONCRETE FRAME

Size: 860×860×50mm | Approx weight: 24kg
Frontlit

Ash		[S80-CA]
Desert		[S80-CD]
Nickel		[S80-CN]
Stone		[S80-CS]
Taupe		[S80-CT]
Coal		[S80-CC]

RRP: \$1789

SPHERE 600D

[S60D]

Size: 600×600×35mm
LED Lighting (Adjustable Colour Temperature)
Backlit

Demister with 1 Hour Auto Cut-off

RRP: \$619

WITH COLOURED ALUMINIUM FRAME

Size: 610×610×40mm
Frontlit

Matt Black		[S60D-MB]
Gun Metal		[S60D-GM]
Brushed Nickel		[S60D-BN]
Rose Gold		[S60D-RG]
Brushed Brass		[S60D-BB]

RRP: \$759

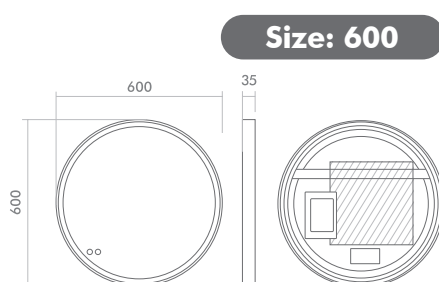

Size: 600

WITH COLOURED CONCRETE FRAME

Size: 660×660×50mm | Approx weight: 18kg
Frontlit

Ash		[S60D-CA]
Desert		[S60D-CD]
Nickel		[S60D-CN]
Stone		[S60D-CS]
Taupe		[S60D-CT]
Coal		[S60D-CC]

RRP: \$1729

SPHERE 800D

[S80D]

Size: 800×800×35mm
LED Lighting (Adjustable Colour Temperature)
Backlit

Demister with 1 Hour Auto Cut-off

RRP: \$809

WITH COLOURED ALUMINIUM FRAME

Size: 810×810×40mm
Frontlit

Matt Black		[S80D-MB]
Gun Metal		[S80D-GM]
Brushed Nickel		[S80D-BN]
Rose Gold		[S80D-RG]
Brushed Brass		[S80D-BB]

RRP: \$1039

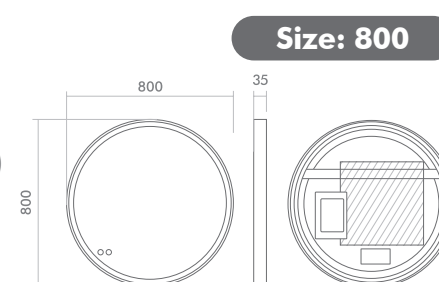

Size: 800

WITH COLOURED CONCRETE FRAME

Size: 860×860×50mm | Approx weight: 24kg
Frontlit

Ash		[S80D-CA]
Desert		[S80D-CD]
Nickel		[S80D-CN]
Stone		[S80D-CS]
Taupe		[S80D-CT]
Coal		[S80D-CC]

RRP: \$1899

SPHERE 600DB

[S60DB]

Size: 600×600×40mm
LED Lighting (Adjustable Colour Temperature)
Backlit

Demister with 1 Hour Auto Cut-off
Bluetooth Speakers

RRP: \$979

WITH COLOURED ALUMINIUM FRAME

Size: 610×610×45mm
Frontlit

Matt Black		[S60DB-MB]
Gun Metal		[S60DB-GM]
Brushed Nickel		[S60DB-BN]
Rose Gold		[S60DB-RG]
Brushed Brass		[S60DB-BB]

RRP: \$1119

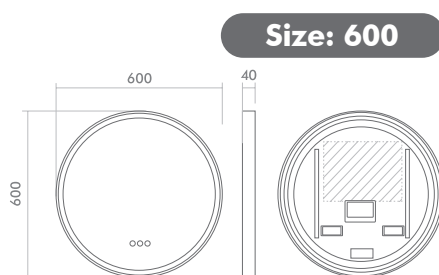

Size: 600

WITH COLOURED CONCRETE FRAME

Size: 660×660×50mm | Approx weight: 18kg
Frontlit

Ash		[S60DB-CA]
Desert		[S60DB-CD]
Nickel		[S60DB-CN]
Stone		[S60DB-CS]
Taupe		[S60DB-CT]
Coal		[S60DB-CC]

RRP: \$1909

SPHERE 800DB

[S80DB]

Size: 800×800×40mm
LED Lighting (Adjustable Colour Temperature)
Backlit

Demister with 1 Hour Auto Cut-off
Bluetooth Speakers

RRP: \$1219

WITH COLOURED ALUMINIUM FRAME

Size: 810×810×45mm
Frontlit

Matt Black		[S80DB-MB]
Gun Metal		[S80DB-GM]
Brushed Nickel		[S80DB-BN]
Rose Gold		[S80DB-RG]
Brushed Brass		[S80DB-BB]

RRP: \$1449

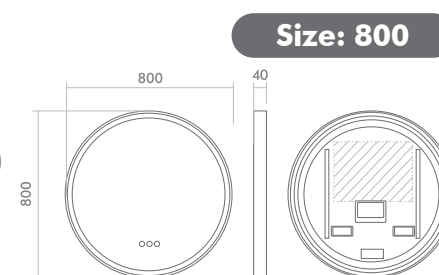

Size: 800

WITH COLOURED CONCRETE FRAME

Size: 860×860×50mm | Approx weight: 24kg
Frontlit

Ash		[S80DB-CA]
Desert		[S80DB-CD]
Nickel		[S80DB-CN]
Stone		[S80DB-CS]
Taupe		[S80DB-CT]
Coal		[S80DB-CC]

RRP: \$2069



NON LED MIRRORS

Add a touch of elegance and sophistication to your home.



REMER
As seen on
THE BLOCK

MODERN ARCH



MODERN OBLONG



MODERN ROUND

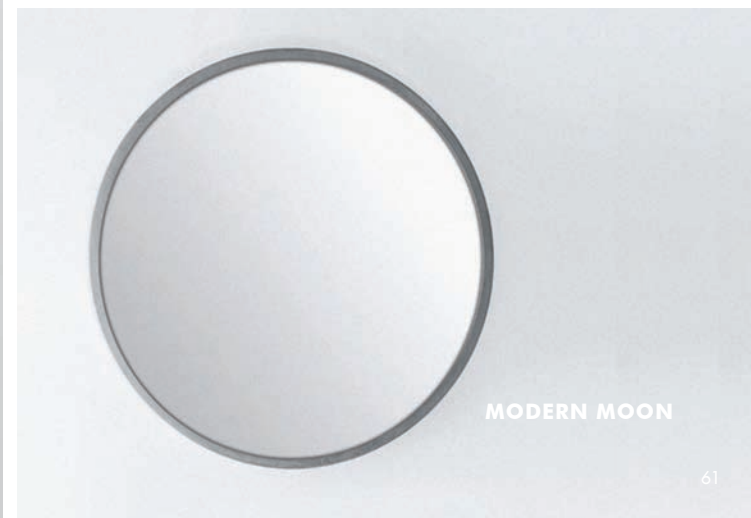





MODERN MOON

MODERN ARCH 500

Size: 510×910×40mm
Copper Free Mirror

WITH COLOURED ALUMINIUM FRAME

Matt Black		MA51-MB
Gun Metal		MA51-GM
Brushed Nickel		MA51-BN
Rose Gold		MA51-RG
Brushed Brass		MA51-BB

RRP: \$499

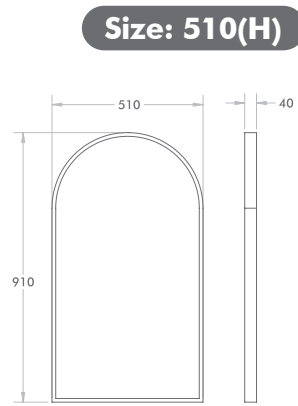





Size: 510(H)

MODERN OBLONG 460X910

Size: 460×910×40mm
Copper Free Mirror
Landscape/Portrait

WITH COLOURED ALUMINIUM FRAME

Matt Black		MO4691-MB
Gun Metal		MO4691-GM
Brushed Nickel		MO4691-BN
Rose Gold		MO4691-RG
Brushed Brass		MO4691-BB

RRP: \$529

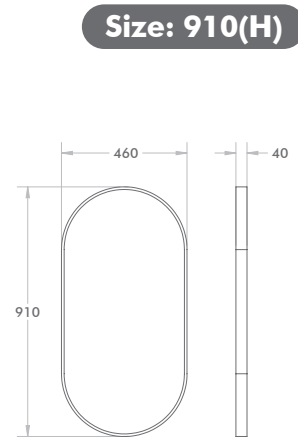





Size: 910(H)

MODERN OBLONG 460X1210

Size: 460×1210×40mm
Copper Free Mirror
Landscape/Portrait

WITH COLOURED ALUMINIUM FRAME

Matt Black		MO46121-MB
Gun Metal		MO46121-GM
Brushed Nickel		MO46121-BN
Rose Gold		MO46121-RG
Brushed Brass		MO46121-BB

RRP: \$609

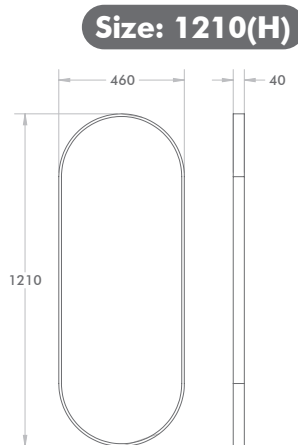





Size: 1210(H)

- Note:
- Coloured aluminium frame made-to-order: please allow 5 business days for dispatch.
 - Coloured concrete frame made-to-order: please allow 8 weeks for dispatch.
 - Actual colours may vary so please check color samples before ordering.
 - Made-to-order cannot be cancelled, altered, exchanged or refunded unless faulty or damaged.

MODERN ROUND 610

Size: 610×610×40mm
Copper Free Mirror

WITH COLOURED ALUMINIUM FRAME

Matt Black		MR61-MB
Gun Metal		MR61-GM
Brushed Nickel		MR61-BN
Rose Gold		MR61-RG
Brushed Brass		MR61-BB

RRP: \$459

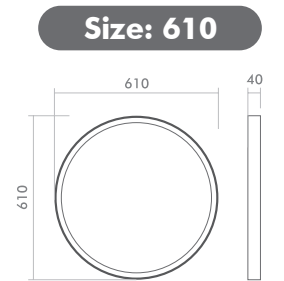





Size: 610

MODERN ROUND 810

Size: 810×810×40mm
Copper Free Mirror

WITH COLOURED ALUMINIUM FRAME

Matt Black		MR81-MB
Gun Metal		MR81-GM
Brushed Nickel		MR81-BN
Rose Gold		MR81-RG
Brushed Brass		MR81-BB

RRP: \$519

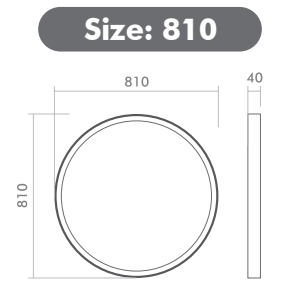

Size: 810

MODERN MOON 660

Size: 660×660×50mm
Copper Free Mirror
Approx weight: 12kg

WITH COLOURED CONCRETE FRAME

Ash		MM66-CA
Desert		MM66-CD
Nickel		MM66-CN
Stone		MM66-CS
Taupe		MM66-CT
Coal		MM66-CC

RRP: \$1269

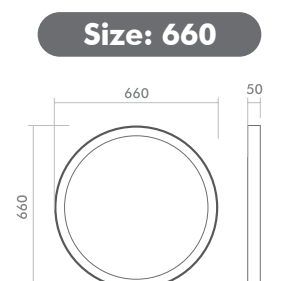

Size: 660

MODERN MOON 860

Size: 860×860×50mm
Copper Free Mirror
Approx weight: 14kg

WITH COLOURED CONCRETE FRAME

Ash		MM86-CA
Desert		MM86-CD
Nickel		MM86-CN
Stone		MM86-CS
Taupe		MM86-CT
Coal		MM86-CC

RRP: \$1379

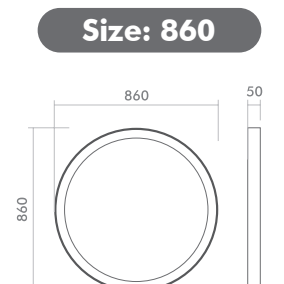

Size: 860



LED SHAVING CABINETS

Storage and advanced technology, the perfect balance of realism and artistry.

PEARL 900
[P90D]



SOFT CLOSE HINGE

Along with the clip-on system and adjustable hinges, the hinge provides a smooth and silent close to reduce noise and eliminate the slamming of doors.



CONCEALED WIRE TECHNOLOGY

Maintains the aesthetic interior look of a shaving cabinet with advanced technologies (lighting, demister and touch sensor) on the doors. Without wiring connecting the doors to the carcass, the doors can be easily removed for installation and maintenance.



DOUBLE SIDED MIRRORS DOORS

With both double-sided mirror doors opened, you are able to use the internal mirror to look at the back of your head effortlessly.



SEMI RECESSABLE

With touch sensor technology and pilot hole, the shaving cabinet can be easily semi-recessed into walls to free up space.



ADJUSTABLE GLASS SHELVES

Tempered glass shelves can be adjusted to the millimetre on the integrated rail slate system. Without the visibility of pre-drilled shelving holes, it offers a clean, minimalist look.

AMBER



FEATURES	AMBER
Copper Free Mirror	●
LED Lighting	●
Demister on all Doors	●
Soft Close	●
Touch Sensor	●
Concealed Wire Technology	●
Finish: Silver Aluminium	●
Adjustable Glass Shelves	●
Double-Sided Mirror Doors	●
AVAILABLE SIZE (mm)	
750 × 700 × 145	✓
900 × 700 × 145	✓
1200 × 700 × 145	✓
1500 × 700 × 145 (3 Doors)	✓

LIGHTING SPECIFICATIONS

CCT: 6500K – daylight
CRI: >80

INSTALLATION

Input voltage: 220-240v 50Hz
Hardwire
Includes wall mount split batten
Mounting holes are provided
for semi-recessed mounting

Refer to page 70-71 for more information

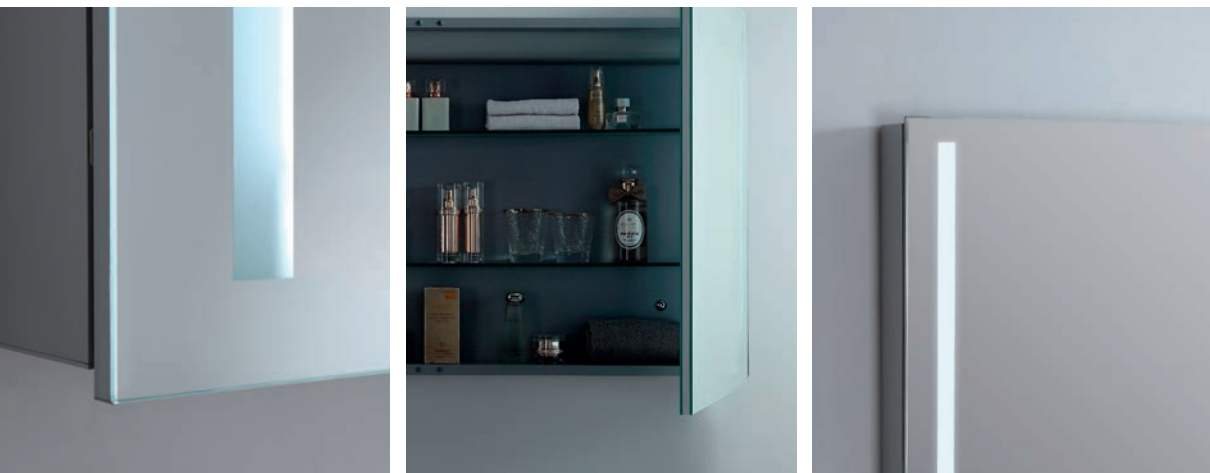

AMBER 750
[A75D]

Size: 750×700×145mm
LED Lighting
Frontlit
Demister

Size: 750

RRP: \$1479

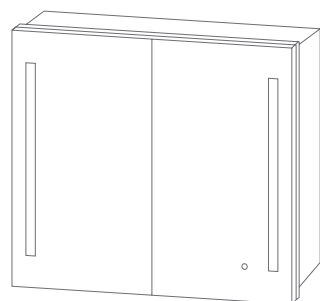
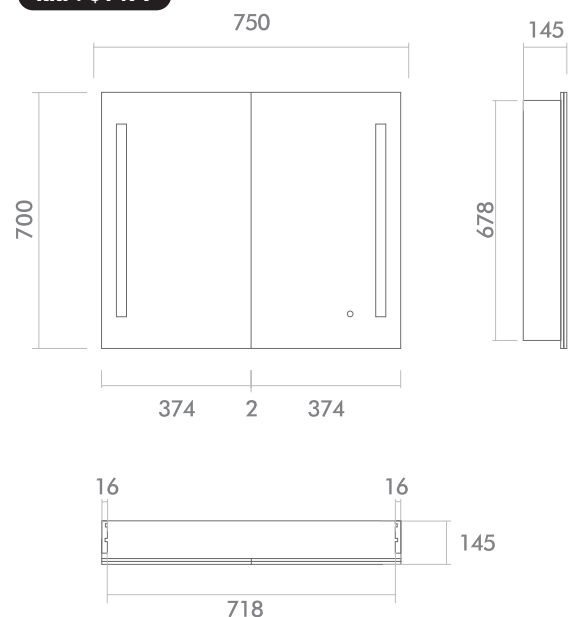

AMBER 1200
[A120D]

Size: 1200×700×145mm
LED Lighting
Frontlit
Demister

Size: 1200

RRP: \$2119

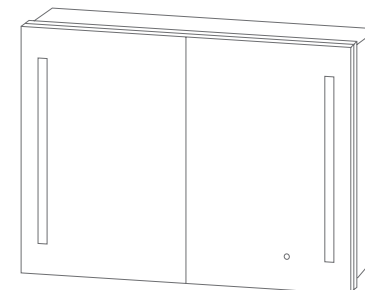
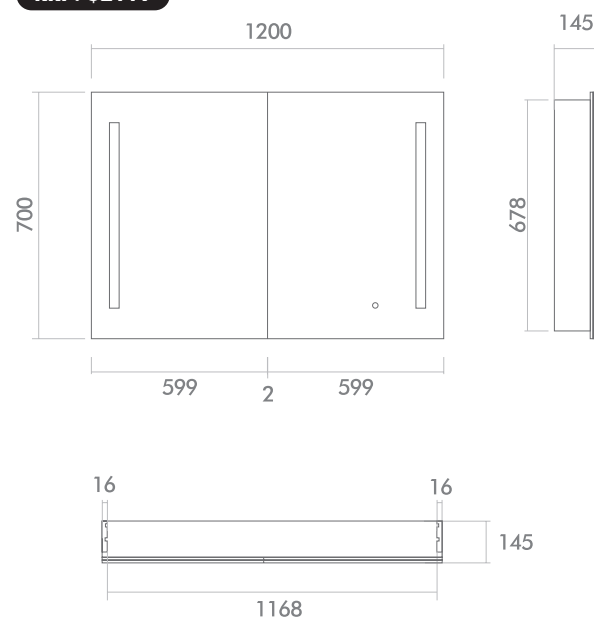

AMBER 900
[A90D]

Size: 900×700×145mm
LED Lighting
Frontlit
Demister

Size: 900

RRP: \$1569

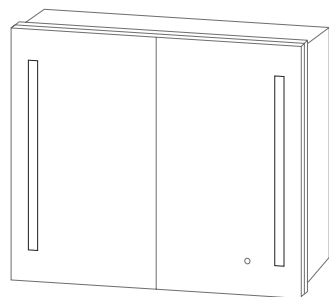
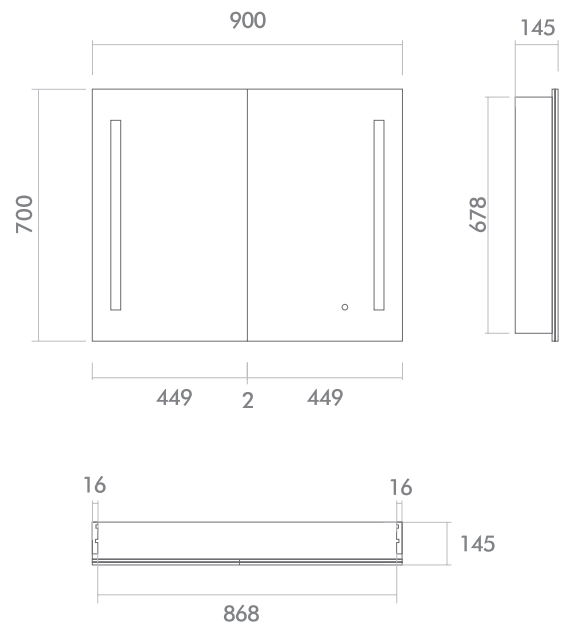

AMBER 1500
[A150D]

Size: 1500×700×145mm
LED Lighting
Frontlit
Demister

Size: 1500

RRP: \$2598

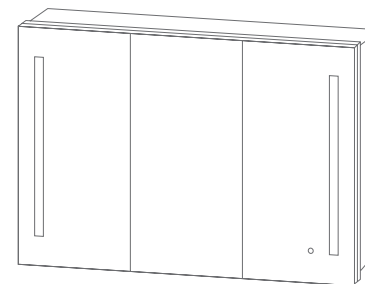
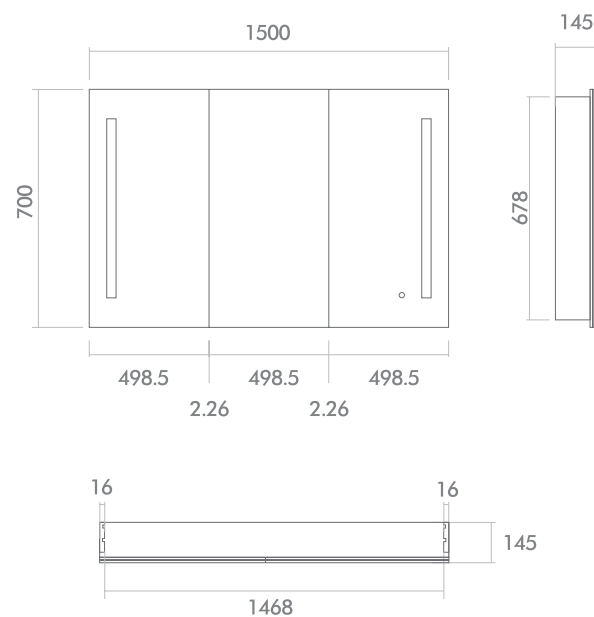

CAPSULE



FEATURES	CAPSULE
Copper Free Mirror	•
LED Lighting	•
Demister	•
Soft Close	•
Touch Sensor	•
Concealed Wire Technology	•
Finish: White Aluminium	•
Adjustable Glass Shelves	•
Single-Sided Mirror Door	•
AVAILABLE SIZE (mm)	
450 x 900 x 143	✓

LIGHTING SPECIFICATIONS

CCT: 6500K – daylight
CRI: >80

INSTALLATION

Input voltage: 220-240v 50Hz
Hardwire
Includes wall mount split batten
Mounting holes are provided
for semi-recessed mounting

CAPSULE 450 [CR45D]

Size: 450x900x143mm
LED Lighting
Frontlit
Demister

RRP: \$1699

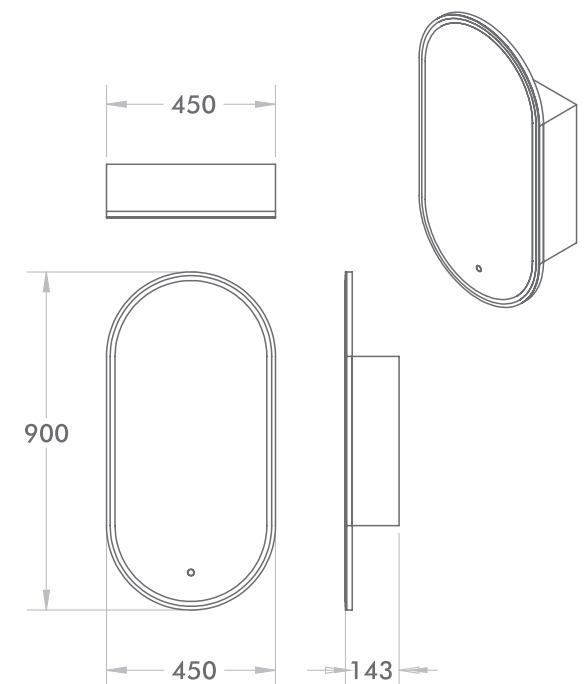

PEARL



FEATURES	PEARL
Copper Free Mirror	●
LED Lighting	●
Demister	●
Soft Close	●
Touch Sensor	●
Concealed Wire Technology	●
Finish: White Aluminium	●
Adjustable Glass Shelves	●
Single-Sided Mirror Door	●
AVAILABLE SIZE (mm)	
900 x 900 x 146	✓

LIGHTING SPECIFICATIONS

CCT: 6500K – daylight
CRI: >80

INSTALLATION

Input voltage: 220-240v 50Hz
Hardwire
Includes wall mount split batten
Mounting holes are provided for semi-recessed mounting
Fully reversible

PEARL 900 [P90D]

Size: 900 x 900 x 146mm
LED Lighting
Frontlit
Demister

RRP: \$1809

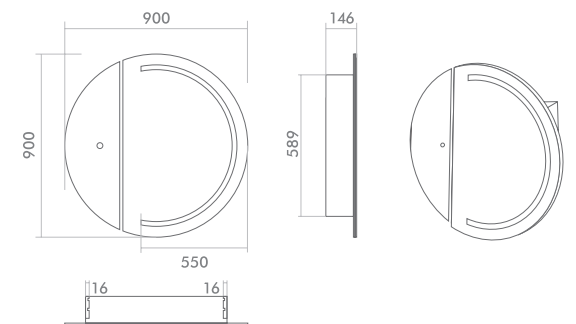

VERA

VERA 1200
[V120D]



VERA



FEATURES	VERA
Copper Free Mirror	●
LED Lighting	●
Demister on all Doors	●
Soft Close	●
Touch Sensor	●
Concealed Wire Technology	●
Finish: Silver Aluminium	●
Adjustable Glass Shelves	●
Double-Sided Mirror Doors	●
AVAILABLE SIZE (mm)	
750 x 700 x 145	✓
900 x 700 x 145	✓
1200 x 700 x 145	✓
1500 x 700 x 145 (3 Doors)	✓

LIGHTING SPECIFICATIONS

CCT: 6500K – daylight
CRI: >80

INSTALLATION

Input voltage: 220-240v 50Hz
Hardwire
Includes wall mount split batten
Mounting holes are provided
for semi-recessed mounting

Refer to page 80-81 for more information



VERA 750
[V75D]

Size: 750×700×145mm
LED Lighting
Frontlit
Demister

RRP: \$1569

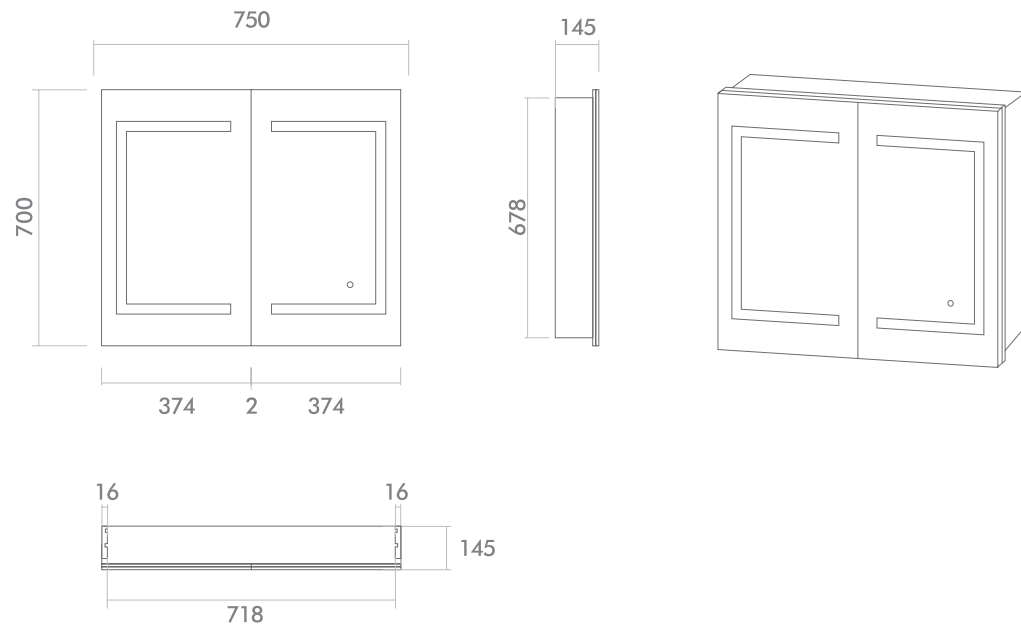

Size: 750

VERA 1200
[V120D]

Size: 1200×700×145mm
LED Lighting
Frontlit
Demister

RRP: \$2449

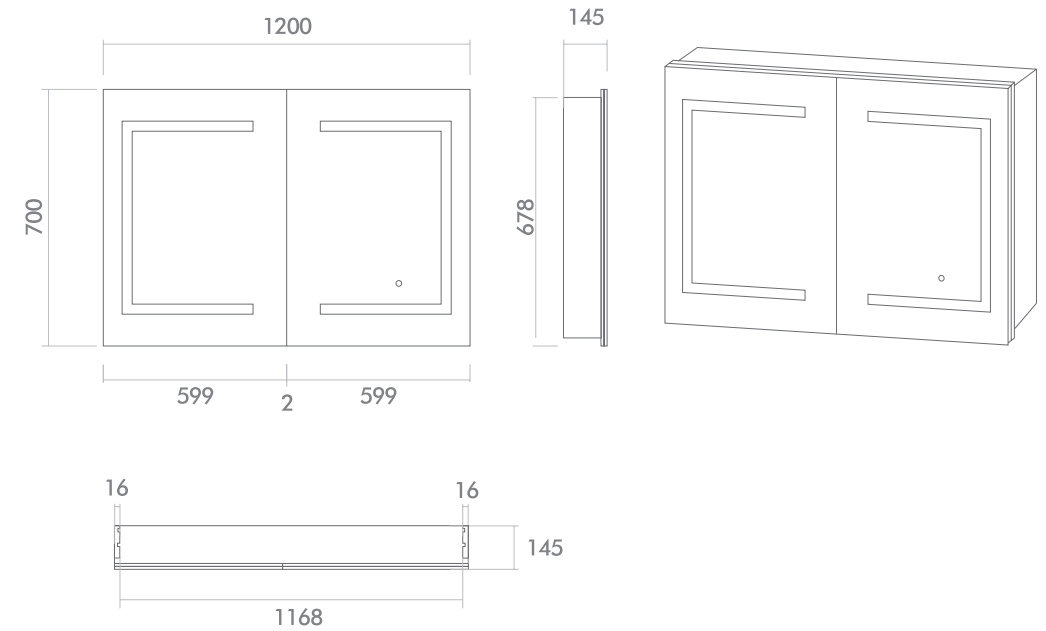

Size: 1200

VERA 900
[V90D]

Size: 900×700×145mm
LED Lighting
Frontlit
Demister

RRP: \$1689

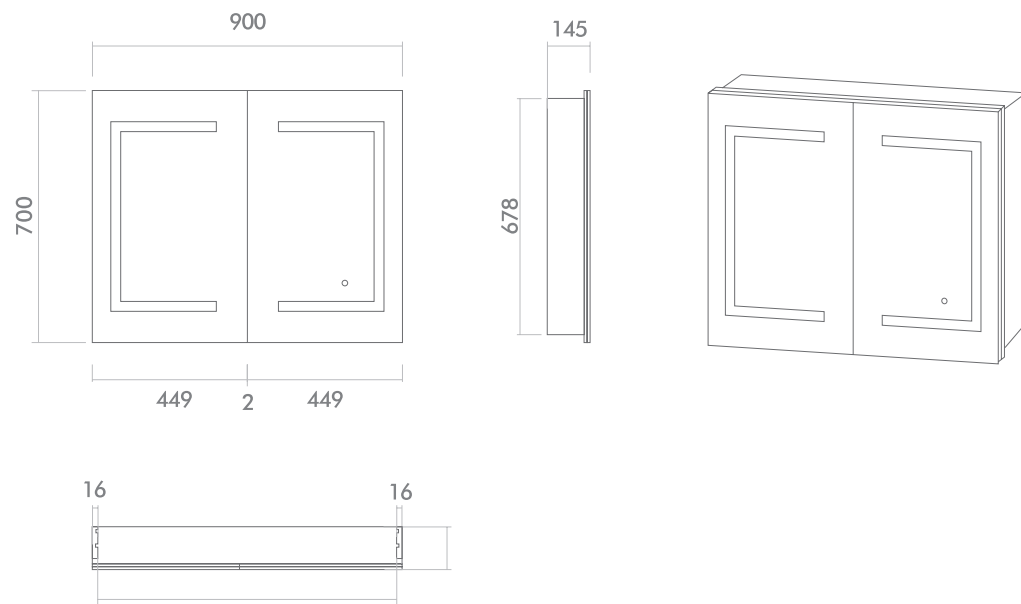

Size: 900

VERA 1500
[V150D]

Size: 1500×700×145mm
LED Lighting
Frontlit
Demister

RRP: \$2949

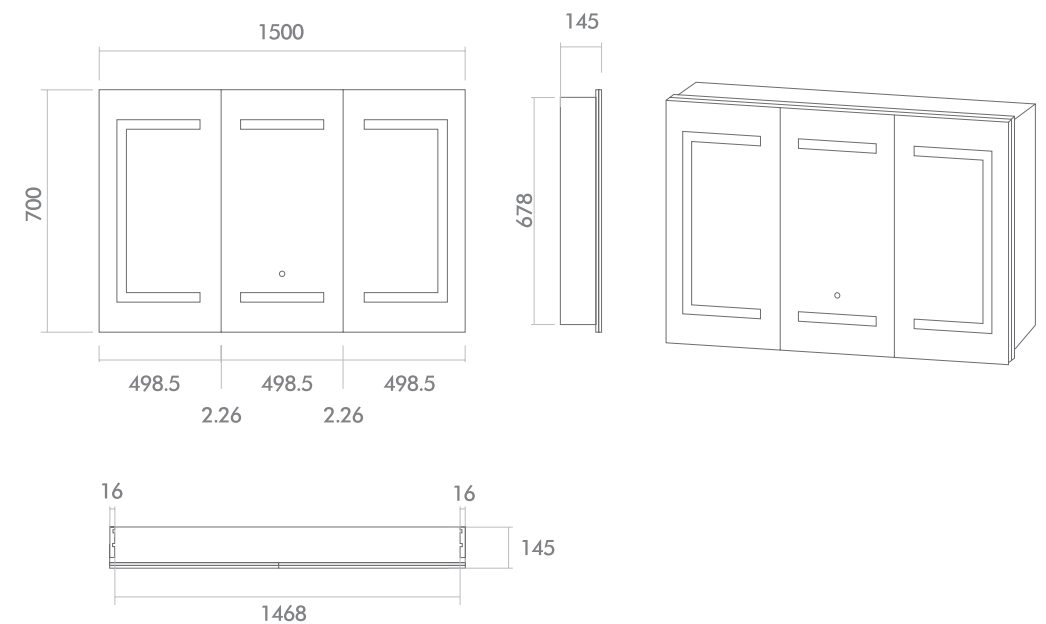

Size: 1500

REMER

MANUFACTURER'S WARRANTY

At Remer Pty Ltd (Remer), we pride ourselves on supplying products of a high industry standard and quality.

Our goods come with guarantees that cannot be excluded under the Australian Consumer Law. You are entitled to a replacement or refund for a major failure and compensation for any other reasonably foreseeable loss or damage. You are also entitled to have the goods repaired or replaced if the goods fail to be of acceptable quality and the failure does not amount to a major failure.

PRODUCT CATEGORY	WARRANTY PROVISIONS
MIRRORS	<p>5 year replacement parts or products for domestic use 1 year replacement parts or products for commercial use</p> <p>Labour is not included</p>
SHAVING	<p>5 year replacement parts or products for domestic use 1 year replacement parts or products for commercial use</p> <p>Labour is not included Door alignment is not included</p>

- The Product Warranty Period commences from the date of purchase
- Remer will replace or repair, at its sole discretion, the defective product, or parts thereof. Replaced products become Remer's property.
- Remer is not responsible for the labor and rectification costs related to the repair or replacement of the product.
- Installation is acceptance of our products. Installation of faulty, warped, chipped, or damaged products will void our warranty. Any claim for warped, chipped or damaged products must be made within 48 hours from receipt of product.

EXCLUSION

This warranty does not cover the following:

- Inability to provide Proof of Purchase and/or Certificate of Electrical Safety (COES) when required by Remer;
- Products that are not installed by a Licensed Electricians and/or tradesperson in accordance with local regulations;
- Material variations. There might be natural variations in the color, pattern, and finish. Products may be slightly different from the ones featured in photos;
- Loss or damages caused by a defective product, and any indirect consequential or other loss or damage, subject to your statutory rights;
- The cost of pickup and delivery
- Loss or damages caused by a defective product, and any indirect consequential or other loss or damage, subject to your statutory rights;

CONDITIONS FOR ON-SITE WARRANTY SERVICE CALLS

Remer will charge a service fee for each visit to an installation by its authorized Service Agent where it is determined that the fault is due to poorly executed or unlicensed installation work, or where the product is not a genuine Remer product or where the product is outside the warranty period. This may be paid in advance by credit card over the phone to a Remer authorized Service Agent attending the site and will be refunded if the Remer product is found to be at fault. Remer requires adequate access to products, fittings, and fixtures to undertake on-site warranty service calls.

HOW TO MAKE A CLAIM

In order to make a claim under the warranty, please visit www.remer.com.au to register your claim by submitting an Online Warranty Claim Form with all required information and documents.

Remer reserves the right to change these terms and conditions at any time without prior notice and the right of final decision on the interpretation of these terms and conditions.

For more information, please visit www.remer.com.au. Thank you for choosing Remer.

For other resources including cleaning and installation instructions, please visit www.remer.com.au

Note:

- Remer Price List 01/07/2022 - 30/06/2023.
- All prices shown correct at time of printing.
- Please use the Product Codes when you place an order.
- Sizes are in mm and nominal and should be checked prior to installation.
- Orders under \$300 (exclusive GST) will attract a \$30 (exclusive GST) freight charge.
- Warranty - 5 years replacement of parts or products. Note: Does not include labor.
- Please note all LED Products requiring hardwiring must be installed by a licensed electrician in accordance with local regulations.
- Coloured aluminium frame made-to-order: please allow 5 business days for dispatch.
- Coloured concrete frame made-to-order: please allow 8 weeks for dispatch.
- Actual colours may vary so please check colour samples before ordering.
- Made-to-order cannot be cancelled, altered, exchanged or refunded unless faulty or damaged.



REMER

For more information visit

remer.com.au

Ph: (03) 9706 6663
13 – 15 Edison Road
Dandenong South
VIC, 3175



Prices are a guide only and subject to change without notice. Please contact your local store for accurate pricing.
Sizes are in mm and nominal and should be checked prior to installation.
5 year replacement warranty